

**PowerWater**



***POWER NETWORKS***

***NETWORK TECHNICAL CODE***  
**and**  
***NETWORK PLANNING CRITERIA***

Version 4 (consolidated updates since Version 3.1)

This version is marked up to show all approved amendments  
as at 30 March 2020

**PowerWater**

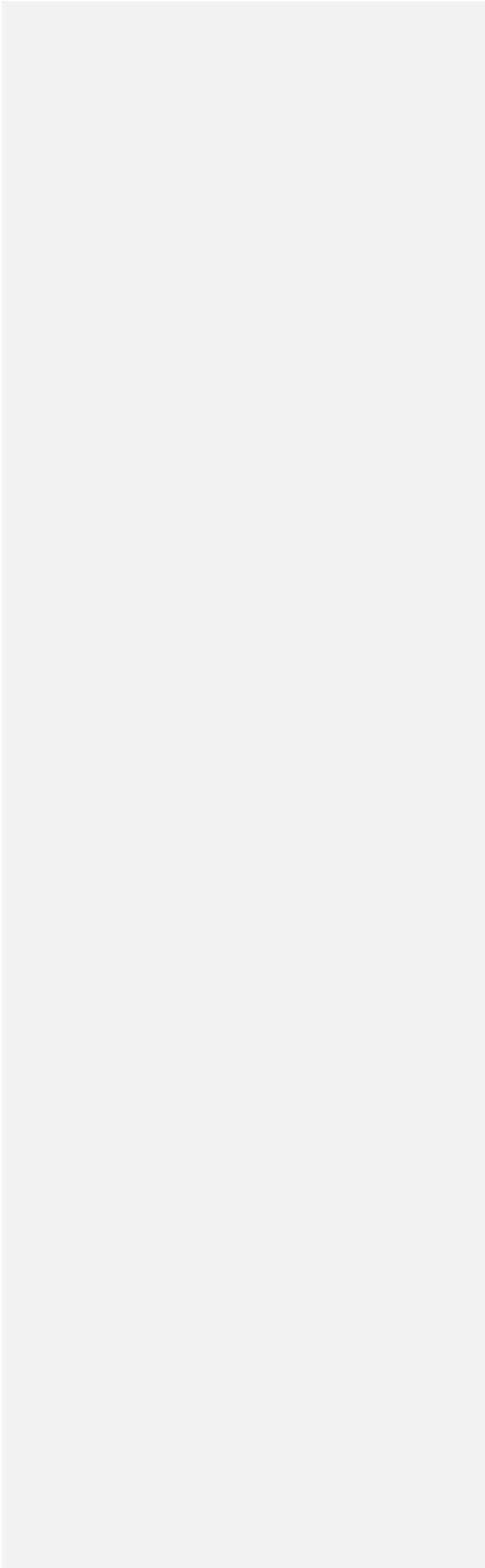

## Table of Contents

<b>INTRODUCTION</b>	<b>1</b>
Structure of this document	1
Document nomenclature	1
Document amendment	1
<b>PART A – LEGISLATIVE REQUIREMENTS</b>	<b>2</b>
Network Technical Code	3
Network Planning Criteria	4
<i>Part B – Network Technical Code</i>	<b>5</b>
<b>1 – APPLICATION</b>	<b>5</b>
1.1 Persons to whom the Code applies	5
1.2 Plant and equipment to which the Code applies	5
1.3 Other documents	5
1.4 Commencement	5
1.5 Interpretation	6
1.6 Dispute resolution	6
1.7 Obligations	7
1.8 Variations and exemptions from the Code	9
1.9 Amendments to the Code	9
<b>2 – Network performance standards</b>	<b>10</b>
2.1 Introduction	10
2.2 Power system operating frequency	10
2.3 Power frequency voltage levels	11
2.4 Quality of supply	11
2.5 Electromagnetic interference	14
2.6 Stability	14
2.7 Contingency criteria for the network	15
2.8 Equipment fault level ratings	15
2.9 Protection arrangements	16
2.10 Variation of service quality parameters	21
<b>3 – Technical requirements for equipment connected to the network</b>	<b>22</b>
3.1 Introduction	22
3.2 Requirements for all network Users	22
3.3 Requirements for connection of Generators	33
3.4 Requirements for connection of Small Generators	49
3.5 Requirements for connection of Small Inverter Energy Systems	57
3.6 Requirements for connection of loads	60
<b>4 – Power system security</b>	<b>63</b>
4.1 Introduction	63
4.2 Power system security principles	63
4.3 Power system security obligations and responsibilities	65
4.4 Power system frequency control	68
4.5 Control of network voltages	69

4.6	Power system operating procedures.....	71
4.7	Power system security operations.....	72
4.8	Power system security support.....	75
4.9	Nomenclature standards.....	77
<b>5</b>	<b>TESTING OF PLANT AND EQUIPMENT.....</b>	<b>79</b>
5.1	Obligations to test <i>plant</i> or equipment.....	79
5.2	<i>Routine testing of protection equipment</i> .....	80
5.3	<i>Testing by Users of their own plant requiring changes to agreed operation</i> .....	80
5.4	<i>Tests to demonstrate Generator compliance</i> .....	81
5.5	Power system tests.....	83
5.6	<i>Compliance with the Network Technical Code</i> .....	84
5.7	Inspection of <i>plant</i> and equipment.....	86
<b>6</b>	<b>Control and protection settings.....</b>	<b>89</b>
6.1	Protection of power system equipment.....	89
6.2	Power system stability co-ordination.....	91
<b>7</b>	<b>COMMISSIONING AND TESTING PROCEDURES.....</b>	<b>93</b>
7.1	Commissioning.....	93
<b>8</b>	<b>Disconnection and reconnection of plant and equipment.....</b>	<b>96</b>
<b>9</b>	<b>Operation of Generators connected to the network.....</b>	<b>98</b>
9.1	Power system security related market operations.....	98
9.2	Users' plant changes.....	99
9.3	Operation, maintenance and extension planning.....	100
9.4	Generating limits.....	100
<b>10</b>	<b>Metering requirements.....</b>	<b>101</b>
10.1	<i>Purpose of metering clause</i> .....	101
10.2	<i>Metering principles</i> .....	101
10.3	<i>Responsibility for metering installation</i> .....	102
10.4	<i>Metering installation arrangements</i> .....	103
10.5	<i>Register of metering information</i> .....	105
10.6	<i>Testing of metering installation</i> .....	106
10.7	<i>Rights of access to metering data</i> .....	106
10.8	<i>Security of metering installations</i> .....	107
10.9	<i>Processing of metering data for settlement purposes</i> .....	107
10.10	<i>Confidentiality</i> .....	108
10.11	<i>Meter time</i> .....	109
<b>11</b>	<b>Information requirements for network connection.....</b>	<b>110</b>
11.1	Scope.....	110
11.2	<i>Information to be provided by all network Users</i> .....	110
11.3	<i>Information to be provided by Users with Generators</i> .....	111
11.4	<i>Information to be provided by Users with Small Generators</i> .....	112
11.5	<i>Information to be provided by Users with Small Inverter Energy Systems</i> .....	113
11.6	<i>Information to be provided by Users with loads</i> .....	113
<b>12</b>	<b>Derogations from the Code.....</b>	<b>114</b>

12.1	Purpose and application .....	114
12.2	Networks and facilities existing at 1 September 2012 .....	114
<b>Part C</b>	<b>Network Planning Criteria.....</b>	<b>115</b>
<b>13</b>	<b>INTRODUCTION.....</b>	<b>115</b>
13.1	Network design philosophy.....	116
13.2	Amendments to the Planning Criteria .....	116
13.3	132 kV and 66 kV networks.....	116
13.4	Distribution networks.....	117
13.5	Process to assess the need for network reinforcement .....	118
13.6	The process of developing network concept plans .....	119
13.7	Planning Criteria .....	119
13.8	Network development .....	119
13.9	Investment analysis and reporting .....	121
<b>14</b>	<b>Supply contingency criteria.....</b>	<b>122</b>
14.1	Load areas.....	122
14.2	Supply contingencies.....	123
14.3	Equipment capacities.....	123
14.4	Forecast demand .....	123
14.5	Radial supply arrangements .....	124
14.6	Supply contingency criteria.....	124
<b>15</b>	<b>STEADY STATE CRITERIA.....</b>	<b>128</b>
15.1	Real and reactive generating limits .....	128
15.2	Steady state power frequency voltage .....	128
15.3	Thermal rating criteria .....	129
15.4	Fault rating criteria .....	130
<b>16</b>	<b>STABILITY CRITERIA.....</b>	<b>130</b>
16.1	Transient stability .....	131
16.2	Voltage stability criteria .....	134
16.3	Frequency stability criteria .....	136
<b>17</b>	<b>Quality of supply criteria.....</b>	<b>136</b>
17.1	Voltage fluctuation criteria .....	137
17.2	Harmonic voltage and current distortion .....	140
17.3	Voltage unbalance .....	141
17.4	Electromagnetic interference .....	141
<b>18</b>	<b>CONSTRUCTION STANDARDS CRITERIA .....</b>	<b>141</b>
18.1	Conductor selection criteria .....	142
<b>19</b>	<b>ENVIRONMENTAL CRITERIA .....</b>	<b>143</b>
19.1	Social issues.....	143
19.2	Electromagnetic fields .....	143
19.3	Land Use considerations.....	144
19.4	Noise.....	144
19.5	Visual amenity.....	144
<b>PART D</b>	<b>ATTACHMENTS.....</b>	<b>145</b>

Attachment 1 – Glossary of Terms .....	145
Attachment 2 – Rules of interpretation .....	160
Attachment 3 – Technical details for connection and access .....	161
Schedule S3.1 – Generation Unit design data .....	163
Schedule S3.2 – Generation Unit setting data .....	170
Schedule S3.3 – Generator data for small Generation Units .....	171
Schedule S3.4 – Technical data for Small Inverter Energy Systems .....	172
Schedule S3.5 – Network and plant technical data .....	173
Schedule S3.6 – Network plant and apparatus setting data .....	175
Schedule S3.7 – Load characteristics at connection point .....	176
Attachment 4 – Metering requirements .....	177
Attachment 5 – Test schedule .....	180
Attachment 6 – Access Application schedule .....	185

<b>TABLE OF CONTENTS .....</b>	<b>34</b>
<b>INTRODUCTION .....</b>	<b>1</b>
Structure of this document.....	1
Document nomenclature .....	1
Document amendment .....	1
<b>PART A LEGISLATIVE REQUIREMENTS.....</b>	<b>34</b>
<i>Network Technical Code .....</i>	<i>34</i>
<i>Network Planning Criteria .....</i>	<i>19</i>
<b>PART B - NETWORK TECHNICAL CODE .....</b>	<b>25</b>
<b>1 INTRODUCTION .....</b>	<b>25</b>
<b>1.1 Persons to whom the Code applies.....</b>	<b>25</b>
<b>1.2 Plant and equipment to which the Code applies .....</b>	<b>25</b>
<b>1.3 Other documents.....</b>	<b>25</b>
<b>1.4 Commencement .....</b>	<b>35</b>
<b>1.5 Interpretation.....</b>	<b>45</b>
<b>1.5.1 Conflict between Technical Codes.....</b>	<b>45</b>
<b>1.6 Dispute resolution .....</b>	<b>47</b>
<b>1.7 Obligations .....</b>	<b>57</b>
<b>1.7.1 Obligations of the Network Operator .....</b>	<b>57</b>
<b>1.7.2 Obligations of Users.....</b>	<b>58</b>
<b>1.7.3 Obligations of Generator Users .....</b>	<b>68</b>
<b>1.7.4 Obligations of Generator Users with small generating systems.....</b>	<b>68</b>
<b>1.7.5 Obligations of Users with Small Inverter Energy Systems .....</b>	<b>69</b>
<b>1.7.6 Obligations of Users with loads .....</b>	<b>79</b>
<b>1.7.7 Variations and exemptions from the Code .....</b>	<b>79</b>
<b>1.8 Amendments to the Code .....</b>	<b>79</b>
<a href="#">[Type here]</a>	
Version 4	<a href="#">[Approval Date]</a>
Version 4	

<b>2</b>	<b>NETWORK PERFORMANCE STANDARDS</b>	<b>910</b>
2.1	Introduction	910
2.2	Power system operating frequency	910
2.2.1	Frequency range under normal operating conditions	910
2.2.2	Frequency range under abnormal operating conditions	911
2.3	Power frequency voltage levels	1112
2.3.1	Steady state voltage levels	1112
2.3.2	Temporary over-voltages	1112
2.3.3	Step changes in voltage levels	1112
2.4	Quality of supply	12
2.4.1	Voltage fluctuations	12
2.4.2	Harmonic distortion	13
2.4.2.1	Harmonic voltage distortion	13
2.4.2.2	Non-integer harmonic distortion	1413
2.4.2.3	Voltage notching	1514
2.4.2.4	Harmonic current distortion	1514
2.4.2.5	Direct current	1514
2.4.3	Voltage unbalance	1715
2.5	Electromagnetic interference	1715
2.6	Stability	1715
2.6.1	[Deleted]	1815
2.6.2	Dynamic stability	1815
2.6.3	Short term voltage stability	1916
2.7	Contingency criteria for the network	1916
2.8	Equipment fault level ratings	1916
2.9	Protection arrangements	2117
2.9.1	Users' obligation to provide adequate protection	2117
2.9.1.1	Safety of people	2117
2.9.1.2	System <i>reliability</i> and integrity	2117
2.9.1.3	Minimum standard of <i>protection</i> equipment	2117
2.9.1.4	General requirements	2117
2.9.2	Duplication of protection	2218



2.9.2.1	Equipment connected at voltages of 66 kV and above .....	224
2.9.2.2	Equipment connected at voltages of less than 66 kV .....	234
<b>2.9.3</b>	<b>Availability of protection systems.....</b>	<b>241</b>
<b>2.9.4</b>	<b>Maximum total fault clearance times .....</b>	<b>241</b>
<b>2.9.5</b>	<b>Critical fault clearance times .....</b>	<b>252</b>
2.9.5.1	Critical fault clearance times.....	262
<b>2.9.6</b>	<b>Protection sensitivity .....</b>	<b>272</b>
<b>2.9.7</b>	<b>Trip supply supervision .....</b>	<b>272</b>
<b>2.9.8</b>	<b>Trip circuit supervision .....</b>	<b>272</b>
<b>2.9.9</b>	<b>Protection flagging, indication, fault and event records.....</b>	<b>272</b>
<b>2.10</b>	<b>Variation of service quality parameters .....</b>	<b>282</b>
<b>3</b>	<b>TECHNICAL REQUIREMENTS FOR EQUIPMENT CONNECTED TO THE NETWORK.....</b>	<b>292</b>
<b>3.1</b>	<b>Introduction .....</b>	<b>292</b>
<b>3.2</b>	<b>Requirements for Network Users excluding Generator Users under clause 3.3.....</b>	<b>292</b>
<b>3.2.1</b>	<b>Network performance standards.....</b>	<b>292</b>
3.2.1.1	Voltage fluctuations .....	302
3.2.1.2	Harmonic voltage distortion .....	302
3.2.1.3	Direct current injection .....	312
3.2.1.4	Voltage unbalance.....	312
3.2.1.5	Stability.....	312
3.2.1.6	Electromagnetic interference .....	312
3.2.1.7	Fault levels.....	312
3.2.1.8	Main switch.....	332
3.2.1.9	Users' power quality monitoring equipment .....	332
3.2.1.10	Power system simulation studies .....	332
3.2.1.11	Technical matters to be coordinated .....	342
<b>3.2.2</b>	<b>Provision of information .....</b>	<b>342</b>
<b>3.2.3</b>	<b>Protection requirements .....</b>	<b>342</b>
3.2.3.1	Transmission lines and other Plant operated at 66 kV and above.....	342
3.2.3.2	Interconnectors and ties operated at 33 kV and below .....	362
3.2.3.3	Feeders, reactors, capacitors and other plant operated at 33 kV and below .....	362
3.2.3.4	Transformers.....	362
3.2.3.5	Protection discrimination .....	382
3.2.3.6	Backup protection .....	382
3.2.3.7	Protection alarm requirements.....	392
3.2.3.8	Islanding of a User's facilities from the power system.....	402
3.2.3.9	Automatic reclose equipment .....	402
3.2.3.10	Maintenance of protection.....	402

<b>3.2.4 Design requirements for Users' substations .....</b>	<b><u>4129</u></b>
<b>3.2.5 Remote monitoring and control requirements .....</b>	<b><u>4230</u></b>
<b>3.2.6 Communications equipment .....</b>	<b><u>4331</u></b>
<b>3.2.7 Secure electricity supplies .....</b>	<b><u>4332</u></b>
<b>3.2.8 Load shedding facilities .....</b>	<b><u>4332</u></b>
3.2.8.1 Load to be available for disconnection.....	<u>4332</u>
3.2.8.2 Installation and testing of load shedding facilities.....	<u>4532</u>
<b>3.2.9 Impact on power system performance .....</b>	<b><u>4533</u></b>
<b>3.2.10 Safety criteria .....</b>	<b><u>4633</u></b>
<b>3.2.11 Environmental criteria .....</b>	<b><u>4633</u></b>
<b>3.2.12 Construction criteria .....</b>	<b><u>4634</u></b>
3.2.12.1 Overhead lines .....	<u>4634</u>
3.2.12.2 Underground cables .....	<u>4634</u>
<b>3.3 Requirements for connection of Generators .....</b>	<b><u>4634</u></b>
<b>3.3.1 Outline of requirements.....</b>	<b><u>4934</u></b>
<b>3.3.2 Application of settings .....</b>	<b><u>6335</u></b>
<b>3.3.3 Technical matters to be co-ordinated .....</b>	<b><u>6436</u></b>
<b>3.3.4 Provision of information .....</b>	<b><u>6537</u></b>
<b>3.3.5 Technical requirements.....</b>	<b><u>6739</u></b>
3.3.5.1 Reactive Power Capability .....	<u>6941</u>
3.3.5.2 Quality of Electricity Generated.....	<u>7042</u>
3.3.5.3 Generating Unit Response to Frequency Disturbance .....	<u>7042</u>
3.3.5.4 Generating System Response to Voltage Disturbances .....	<u>7143</u>
3.3.5.5 Generating System Response to Disturbances Following Contingency Events .....	<u>7244</u>
3.3.5.6 Quality of Electricity Generated and Continuous Uninterrupted Operation.....	<u>7648</u>
3.3.5.7 Partial Load Rejection.....	<u>7648</u>
3.3.5.8 Protection of Generating Units from Power System Disturbances.....	<u>7649</u>
3.3.5.9 Protection Systems that Impact on Power System Security.....	<u>7850</u>
3.3.5.10 Protection to Trip Plant for Unstable Operation.....	<u>7951</u>
3.3.5.11 Frequency Control.....	<u>7951</u>
3.3.5.12 Impact on Network Capability .....	<u>8153</u>
3.3.5.13 Voltage and Reactive Power Control.....	<u>8154</u>
3.3.5.14 Active Power Control.....	<u>8758</u>
3.3.5.15 Inertia and Contingency FCAS .....	<u>8859</u>
3.3.5.16 System Strength .....	<u>8960</u>
3.3.5.17 Capacity Forecasting.....	<u>9061</u>
<b>3.3.6 Monitoring and Control Requirements .....</b>	<b><u>9162</u></b>
3.3.6.1 Remote Monitoring and Control.....	<u>9162</u>

3.3.6.2 Communications Equipment .....	936
<b>3.3.7 Power station auxiliary supplies .....</b>	<b>946</b>
<b>3.3.8 Fault current .....</b>	<b>946</b>
<b>3.4 Requirements for connection of Small Generators .....</b>	<b>956</b>
<b>3.4.1 Scope .....</b>	<b>956</b>
<b>3.4.2 Objectives .....</b>	<b>966</b>
<b>3.4.3 Categorisation of facilities .....</b>	<b>966</b>
<b>3.4.4 Information to be provided by a Small Generator .....</b>	<b>976</b>
<b>3.4.5 Safety and reliability .....</b>	<b>976</b>
<b>3.4.6 Small Generation Unit characteristics .....</b>	<b>986</b>
<b>3.4.7 Connection and operation .....</b>	<b>986</b>
3.4.7.1 Main switch .....	986
3.4.7.2 Synchronising .....	986
3.4.7.3 Safe shutdown without external supply .....	1006
<b>3.4.8 Power quality and voltage change .....</b>	<b>1006</b>
<b>3.4.9 Remote control, monitoring and communications .....</b>	<b>1007</b>
<b>3.4.10 Protection .....</b>	<b>1027</b>
3.4.10.1 General .....	1027
3.4.10.2 Pole slipping .....	1047
3.4.10.3 Islanding protection and intertripping .....	1047
3.4.10.4 Protection of Small Generator's equipment .....	1047
<b>3.4.11 Commissioning and testing .....</b>	<b>1047</b>
<b>3.4.12 Technical matters to be coordinated .....</b>	<b>1057</b>
<b>3.5 Requirements for connection of Small Inverter Energy Systems .....</b>	<b>1057</b>
<b>3.5.1 Scope .....</b>	<b>1057</b>
<b>3.5.2 Relevant standards .....</b>	<b>1057</b>
<b>3.5.3 Metering installation .....</b>	<b>1077</b>
<b>3.5.4 Safety .....</b>	<b>1077</b>
<b>3.5.5 Security of operational settings .....</b>	<b>1077</b>
<b>3.5.6 Circuit arrangements .....</b>	<b>1077</b>
3.5.6.1 Schematic diagram .....	1077

<b>3.5.7 Protection</b> .....	<b>10775</b>
3.5.7.1 <i>Islanding protection</i> .....	10775
3.5.7.2 <i>Synchronising</i> .....	10875
3.5.7.3 <i>Reconnection to network</i> .....	10975
3.5.7.4 <i>Overcurrent protection</i> .....	10975
3.5.7.5 <i>Voltage limits</i> .....	10975
3.5.7.6 <i>Frequency limits</i> .....	10976
<b>3.5.8 Commissioning and testing</b> .....	<b>10976</b>
3.5.8.1 <i>Commissioning</i> .....	10976
3.5.8.2 <i>Re-confirmation of correct operation</i> .....	11177
<b>3.6 Requirements for connection of loads</b> .....	<b>11177</b>
<b>3.6.1 Connection point for a User</b> .....	<b>11177</b>
<b>3.6.2 Information</b> .....	<b>11277</b>
<b>3.6.3 Design standards</b> .....	<b>11377</b>
<b>3.6.4 Users' protection systems that impact on power system security</b> .....	<b>11378</b>
<b>3.6.5 Thermal limits</b> .....	<b>11478</b>
<b>3.6.6 Fault limits</b> .....	<b>11478</b>
<b>3.6.7 Power factor requirements</b> .....	<b>11579</b>
<b>4 POWER SYSTEM OPERATION SUPPORT</b> .....	<b>11679</b>
4.1 [Deleted].....	11980
4.2 [Deleted].....	11980
4.3 <i>Responsibilities</i> .....	11980
4.3.1 [Deleted].....	11980
4.3.2 <i>Network Operator</i> .....	11980
4.3.3 [Deleted].....	12381
4.3.4 <i>Users</i> .....	12381
4.4 [Deleted].....	12481
4.5 <i>Voltage control</i> .....	12481
4.5.1 <i>Network voltage control</i> .....	12581
4.5.2 [Deleted].....	12882
4.6 <i>Network operations and power system security support</i> .....	12882

<del>4.6.1</del> Network operations.....	<del>1288</del>
<del>4.6.2</del> Switching of reactive power facilities.....	<del>1288</del>
<del>4.6.3</del> [Deleted] .....	<del>1308</del>
<del>4.7</del> Other system security support measures.....	<del>1308</del>
<del>4.7.1</del> [Deleted] .....	<del>1318</del>
<del>4.7.2</del> [Deleted] .....	<del>1318</del>
<del>4.7.3</del> [Deleted] .....	<del>1318</del>
<del>4.7.4</del> [Deleted] .....	<del>1318</del>
<del>4.7.5</del> Managing electricity supply shortfall events .....	<del>1318</del>
<del>4.7.6</del> Directions by the Network Operator.....	<del>1318</del>
<del>4.7.7</del> Disconnection of generating units and/or associated loads.....	<del>1338</del>
<del>4.7.8</del> Emergency black start-up facilities .....	<del>1338</del>
<del>4.7.9</del> [Deleted] .....	<del>1338</del>
<del>4.7.10</del> Black system start-up.....	<del>1338</del>
<del>4.7.11</del> [Deleted] .....	<del>1378</del>
<del>4.8</del> Agent communications .....	<del>1378</del>
<del>4.9</del> Nomenclature standards.....	<del>1378</del>
<del>5</del> TESTING OF <i>PLANT</i> AND EQUIPMENT .....	<del>1388</del>
<del>5.1</del> Obligations to test plant or equipment.....	<del>1408</del>
<del>5.1.1</del> Network Operator obligations.....	<del>1408</del>
<del>5.1.2</del> Network Users' obligations .....	<del>1408</del>
<del>5.2</del> Routine testing of protection equipment.....	<del>1418</del>
<del>5.3</del> Testing by Users of their own plant requiring changes to agreed operation .....	<del>1418</del>
<del>5.4</del> Tests to demonstrate Generator compliance .....	<del>1438</del>
<del>5.4.1</del> Tests of generating units requiring changes to agreed operation.....	<del>1448</del>
<del>5.5</del> Power system tests .....	<del>1469</del>
<del>5.6</del> Compliance with the Network Technical Code .....	<del>1479</del>

<b>5.6.1</b>	<b>Right of inspection and testing .....</b>	<b>14791</b>
<b>5.6.2</b>	<b>Generator compliance with the Code .....</b>	<b>14892</b>
<b>5.7</b>	<b>Inspection of <i>plant</i> and equipment.....</b>	<b>14993</b>
<b>5.7.1</b>	<b>Right of entry and inspection .....</b>	<b>14993</b>
<b>6</b>	<b>CONTROL AND PROTECTION SETTINGS .....</b>	<b>15296</b>
<b>6.1</b>	<b>Protection of power system equipment .....</b>	<b>15296</b>
<b>6.1.1</b>	<b>Scope .....</b>	<b>15296</b>
<b>6.1.2</b>	<b>Power system fault levels.....</b>	<b>15296</b>
<b>6.1.3</b>	<b>Power system protection co-ordination.....</b>	<b>15396</b>
<b>6.1.4</b>	<b>Short-term thermal ratings of the power system .....</b>	<b>15397</b>
<b>6.1.5</b>	<b>Availability of protection.....</b>	<b>15497</b>
<b>6.1.6</b>	<b>Partial outage of power protection systems.....</b>	<b>15497</b>
6.1.6.1	<i>Sensitivity of protection .....</i>	<i>15498</i>
6.1.6.2	<i>Clearance of small zone faults .....</i>	<i>15598</i>
6.1.6.3	<i>Clearance of faults under circuit breaker fail conditions .....</i>	<i>15598</i>
6.1.6.4	<i>Details of proposed Users' protection settings.....</i>	<i>15598</i>
6.1.6.5	<i>Coordination of protection settings .....</i>	<i>15598</i>
<b>6.2</b>	<b>Power system stability co-ordination.....</b>	<b>15599</b>
<b>7</b>	<b>COMMISSIONING AND TESTING PROCEDURES.....</b>	<b>15799</b>
<b>7.1</b>	<b>Commissioning .....</b>	<b>15799</b>
<b>7.1.1</b>	<b>Requirement to inspect and test equipment.....</b>	<b>15799</b>
<b>7.1.2</b>	<b>Co-ordination during commissioning .....</b>	<b>15799</b>
<b>7.1.3</b>	<b>Control and protection settings for equipment .....</b>	<b>157100</b>
<b>7.1.4</b>	<b>Commissioning program .....</b>	<b>159100</b>
<b>7.1.5</b>	<b>Commissioning tests .....</b>	<b>159101</b>
7.1.5.1	<i>Commissioning of protection .....</i>	<i>160102</i>
<b>8</b>	<b>DISCONNECTION AND RECONNECTION OF PLANT AND EQUIPMENT.....</b>	<b>161103</b>
<b>8.1.1</b>	<b>Voluntary disconnection .....</b>	<b>161103</b>
<b>8.1.2</b>	<b>Decommissioning procedures.....</b>	<b>161103</b>

<del>8.1.3</del> Involuntary disconnection (refer also to clause 4.7) .....	<del>16110</del>
<del>8.1.4</del> Disconnection due to breach of a connection agreement .....	<del>16210</del>
<del>8.1.5</del> Disconnection during an emergency .....	<del>16310</del>
<del>8.1.6</del> Obligation to reconnect .....	<del>16310</del>
<del>9</del> OPERATION OF <i>GENERATORS CONNECTED TO THE NETWORK</i> .....	<del>16410</del>
<del>9.1</del> Power system security related market operations .....	<del>16410</del>
<del>9.1.1</del> Dispatch related limitations .....	<del>16410</del>
<del>9.1.2</del> [Deleted] .....	<del>16710</del>
<del>9.1.3</del> [Deleted] .....	<del>16710</del>
<del>9.2</del> Users' plant changes .....	<del>16710</del>
<del>9.3</del> Operation, maintenance and extension planning .....	<del>10010</del>
<del>9.4</del> [Deleted] .....	<del>11010</del>
<del>10</del> [DELETED] .....	<del>11110</del>
<del>11</del> INFORMATION REQUIREMENTS FOR <i>NETWORK CONNECTION</i> .....	<del>11210</del>
<del>11.1</del> Scope .....	<del>11210</del>
<del>11.2</del> Information to be provided by all <i>Network Users</i> .....	<del>11210</del>
<del>11.2.1</del> Information on connected plant .....	<del>11210</del>
<del>11.2.2</del> Details of proposed Users' protection .....	<del>11411</del>
<del>11.2.3</del> Requirements where a critical fault clearance time exists .....	<del>11411</del>
<del>11.3</del> [Deleted] .....	<del>11611</del>
<del>11.4</del> Information to be provided by <i>Users with Small Generators</i> .....	<del>11611</del>
<del>11.5</del> Information to be provided by <i>Users with Small Inverter Energy Systems</i> .....	<del>11711</del>
<del>11.6</del> Information to be provided by <i>Users with loads</i> .....	<del>11711</del>
<del>12</del> TRANSITIONAL ARRANGEMENTS AND DEROGATIONS FROM THE <i>CODE</i> .....	<del>11811</del>
<del>12.1</del> Purpose and application .....	<del>11811</del>
<del>Pre 1</del> .....	<del>11911</del>

<b><u>12.2 April 2019 plant and equipment .....</u></b>	<b><u>119114</u></b>
<b><u>12.3 Post 1 April 2019 plant and equipment .....</u></b>	<b><u>120115</u></b>
<b><u>PART C NETWORK PLANNING CRITERIA .....</u></b>	<b><u>123117</u></b>
<b><u>13 INTRODUCTION .....</u></b>	<b><u>123117</u></b>
<b><u>13.1 Network design philosophy.....</u></b>	<b><u>125118</u></b>
<b><u>13.2 Amendments to the Planning Criteria.....</u></b>	<b><u>125118</u></b>
<b><u>13.3 132 kV and 66 kV networks .....</u></b>	<b><u>126119</u></b>
<b><u>13.4 Distribution networks .....</u></b>	<b><u>127119</u></b>
<b><u>13.4.1 CBD area.....</u></b>	<b><u>127119</u></b>
<b><u>13.4.2 Urban areas .....</u></b>	<b><u>127119</u></b>
<b><u>13.4.3 Rural areas .....</u></b>	<b><u>128120</u></b>
<b><u>13.4.4 Enhanced security of supply .....</u></b>	<b><u>129120</u></b>
<b><u>13.4.5 Embedded generation.....</u></b>	<b><u>129120</u></b>
<b><u>13.5 Process to assess the need for network reinforcement.....</u></b>	<b><u>129120</u></b>
<b><u>13.6 The process of developing network concept plans .....</u></b>	<b><u>130121</u></b>
<b><u>13.7 Planning Criteria .....</u></b>	<b><u>130122</u></b>
<b><u>13.8 Network development .....</u></b>	<b><u>130122</u></b>
<b><u>13.8.1 Annual planning review .....</u></b>	<b><u>131122</u></b>
<b><u>13.8.2 Non-network alternatives to network augmentation .....</u></b>	<b><u>132123</u></b>
<b><u>13.9 Investment analysis and reporting.....</u></b>	<b><u>133124</u></b>
<b><u>14 SUPPLY CONTINGENCY CRITERIA .....</u></b>	<b><u>135124</u></b>
<b><u>14.1 Load areas .....</u></b>	<b><u>135125</u></b>
<b><u>14.2 Supply contingencies.....</u></b>	<b><u>136125</u></b>
<b><u>14.3 Equipment capacities .....</u></b>	<b><u>137126</u></b>
<b><u>14.4 Forecast demand .....</u></b>	<b><u>137126</u></b>
<b><u>14.5 Radial supply arrangements .....</u></b>	<b><u>138126</u></b>
<b><u>14.6 Supply contingency criteria .....</u></b>	<b><u>138127</u></b>



<b>15</b>	<b>STEADY STATE CRITERIA .....</b>	<b>128131</b>
15.1	Real and reactive generating limits.....	128131
15.2	Steady state power <i>frequency voltage</i> .....	128131
15.3	Thermal rating criteria .....	130132
15.4	Fault rating criteria .....	131133
<b>16</b>	<b>STABILITY CRITERIA.....</b>	<b>132133</b>
16.1	Angle stability.....	133134
16.1.1	Transient stability criteria .....	133134
16.1.2	Rotor angle swing .....	134135
16.1.3	Fault clearance time.....	134135
16.1.4	Rotor angle swing and transient voltage dip .....	135135
16.1.5	Pole slip protection.....	135135
16.1.6	Small-signal stability .....	135135
16.2	Transient stability .....	135
16.2.1	Oscillation damping .....	136137
16.2.2	Power system stabilisers .....	136137
16.3	<i>Voltage</i> stability criteria.....	136137
16.3.1	Voltage stability limits.....	136137
16.3.2	Voltage collapse.....	138
16.3.3	Resonance conditions .....	138
16.3.4	Transient over-voltages.....	138139
16.3.5	Temporary over-voltages .....	138139
16.3.6	Transient voltage dip criteria (TVD) .....	139
16.4	<i>Frequency</i> stability criteria .....	139
<b>17</b>	<b>QUALITY OF SUPPLY CRITERIA .....</b>	<b>140</b>
17.1	Voltage fluctuation criteria.....	141140
17.1.1	Temporary over-voltages .....	142141

<b>17.1.2</b>	<b>Step changes in voltage levels .....</b>	<b>143141</b>
<b>17.2</b>	<b>Harmonic <i>voltage</i> and current distortion .....</b>	<b>146143</b>
<b>17.2.1</b>	<b>Inter-harmonic distortion .....</b>	<b>148144</b>
<b>17.2.2</b>	<b>Direct current .....</b>	<b>148144</b>
<b>17.3</b>	<b>Voltage unbalance .....</b>	<b>148144</b>
<b>17.4</b>	<b>Electromagnetic interference .....</b>	<b>148144</b>
<b>18</b>	<b>CONSTRUCTION STANDARDS CRITERIA .....</b>	<b>149144</b>
<b>18.1</b>	<b>Conductor selection criteria .....</b>	<b>150145</b>
<b>19</b>	<b>ENVIRONMENTAL CRITERIA.....</b>	<b>151145</b>
<b>19.1</b>	<b>Social issues.....</b>	<b>151146</b>
<b>19.2</b>	<b>Electromagnetic fields.....</b>	<b>151146</b>
<b>19.3</b>	<b>Land-Use considerations .....</b>	<b>152147</b>
<b>19.4</b>	<b>Noise .....</b>	<b>152147</b>
<b>19.5</b>	<b>Visual amenity .....</b>	<b>152147</b>
<b>PART D</b>	<b>ATTACHMENTS.....</b>	<b>145149</b>
<b>Attachment 1</b>	<b>Glossary of Terms .....</b>	<b>145149</b>
<b>Attachment 2</b>	<b>Rules of interpretation.....</b>	<b>175167</b>
<b>Attachment 3</b>	<b>Technical details for <i>connection</i> and access .....</b>	<b>176168</b>
A3.1	Introduction.....	176168
A3.2.1	Preliminary system planning data .....	176168
A3.2.2	Registered system planning data.....	176168
<b>Schedule S3.1</b>	<b><i>Generating unit</i> design data.....</b>	<b>179170</b>
<b>Schedule S3.2</b>	<b><i>Generating unit</i> setting data .....</b>	<b>193178</b>
<b>Schedule S3.3</b>	<b><i>Generator</i> data for small <i>generating systems</i> .....</b>	<b>195179</b>
<b>Schedule S3.4</b>	<b>Technical data for <i>Small Inverter Energy Systems</i> .....</b>	<b>196180</b>
<b>Schedule S3.5</b>	<b><i>Network</i> and <i>plant</i> technical data .....</b>	<b>198181</b>
<b>Schedule S3.6</b>	<b><i>Network plant</i> and apparatus setting data .....</b>	<b>203184</b>
<b>Schedule S3.7</b>	<b><i>Load</i> characteristics at <i>connection point</i>.....</b>	<b>205185</b>

Schedule S4 Grace periods for purposes of clause 12.3.....	208185
Attachment 4 [Deleted].....	210187
Attachment 5 Test schedule .....	211189
<b>TABLE OF CONTENTS</b> .....	<b>1</b>
<b>INTRODUCTION</b> .....	<b>1</b>
Structure of this document.....	1
Document nomenclature .....	1
Document amendment .....	1
<b>PART A – LEGISLATIVE REQUIREMENTS</b> .....	<b>2</b>
<i>Network Technical Code</i> .....	2
<i>Network Planning Criteria</i> .....	3
<b>PART B – NETWORK TECHNICAL CODE</b> .....	<b>5</b>
<b>1 – INTRODUCTION</b> .....	<b>5</b>
1.1 – Persons to whom the Code applies.....	5
1.2 – Plant and equipment to which the Code applies .....	5
1.3 – Other documents.....	5
1.4 – Commencement .....	5
1.5 – Interpretation.....	6
1.5.1 – Conflict between Technical Codes.....	6
1.6 – Dispute resolution .....	7
1.7 – Obligations .....	7
1.7.1 Obligations of the Network Operator .....	7
1.7.2 Obligations of Users.....	8
1.7.3 Obligations of Generator Users .....	8
1.7.4 Obligations of Generator Users with small generating systems.....	8
1.7.5 Obligations of Users with Small Inverter Energy Systems .....	9
1.7.6 Obligations of Users with loads .....	9

<b>1.7.7 Variations and exemptions from the Code</b> .....	<b>9</b>
<b>1.8 Amendments to the Code</b> .....	<b>9</b>
<b>2 NETWORK PERFORMANCE STANDARDS</b> .....	<b>10</b>
<b>2.1 Introduction</b> .....	<b>10</b>
<b>2.2 Power system operating frequency</b> .....	<b>10</b>
<b>2.2.1 Frequency range under normal operating conditions</b> .....	<b>10</b>
<b>2.2.2 Frequency range under abnormal operating conditions</b> .....	<b>11</b>
<b>2.3 Power frequency voltage levels</b> .....	<b>12</b>
<b>2.3.1 Steady state voltage levels</b> .....	<b>12</b>
<b>2.3.2 Temporary over voltages</b> .....	<b>12</b>
<b>2.3.3 Step changes in voltage levels</b> .....	<b>12</b>
<b>2.4 Quality of supply</b> .....	<b>12</b>
<b>2.4.1 Voltage fluctuations</b> .....	<b>12</b>
<b>2.4.2 Harmonic distortion</b> .....	<b>13</b>
2.4.2.1 Harmonic voltage distortion .....	13
2.4.2.2 Non integer harmonic distortion .....	13
2.4.2.3 Voltage notching .....	14
2.4.2.4 Harmonic current distortion .....	14
2.4.2.5 Direct current .....	14
<b>2.4.3 Voltage unbalance</b> .....	<b>15</b>
<b>2.5 Electromagnetic interference</b> .....	<b>15</b>
<b>2.6 Stability</b> .....	<b>15</b>
<b>2.6.1 [Deleted]</b> .....	<b>15</b>
<b>2.6.2 Dynamic stability</b> .....	<b>15</b>
<b>2.6.3 Short term voltage stability</b> .....	<b>16</b>
<b>2.7 Contingency criteria for the network</b> .....	<b>16</b>
<b>2.8 Equipment fault level ratings</b> .....	<b>17</b>
<b>2.9 Protection arrangements</b> .....	<b>17</b>
<b>2.9.1 Users' obligation to provide adequate protection</b> .....	<b>17</b>
2.9.1.1 Safety of people .....	17

2.9.1.2	System <i>reliability</i> and integrity .....	17
2.9.1.3	Minimum standard of <i>protection</i> equipment .....	17
2.9.1.4	General requirements .....	18
<b>2.9.2</b>	<b>Duplication of protection .....</b>	<b>18</b>
2.9.2.1	Equipment <i>connected</i> at <i>voltages</i> of 66 kV and above .....	18
2.9.2.2	Equipment <i>connected</i> at <i>voltages</i> of less than 66 kV .....	19
<b>2.9.3</b>	<b>Availability of protection systems .....</b>	<b>19</b>
<b>2.9.4</b>	<b>Maximum total fault clearance times .....</b>	<b>19</b>
<b>2.9.5</b>	<b>Critical fault clearance times .....</b>	<b>21</b>
2.9.5.1	<i>Critical fault clearance times</i> .....	21
<b>2.9.6</b>	<b>Protection sensitivity .....</b>	<b>21</b>
<b>2.9.7</b>	<b>Trip supply supervision .....</b>	<b>22</b>
<b>2.9.8</b>	<b>Trip circuit supervision .....</b>	<b>22</b>
<b>2.9.9</b>	<b>Protection flagging, indication, fault and event records .....</b>	<b>22</b>
<b>2.10</b>	<b>Variation of service quality parameters .....</b>	<b>22</b>
<b>3</b>	<b>TECHNICAL REQUIREMENTS FOR EQUIPMENT CONNECTED TO THE NETWORK .....</b>	<b>22</b>
<b>3.1</b>	<b>Introduction .....</b>	<b>22</b>
<b>3.2</b>	<b>Requirements for Network Users excluding Generator Users under clause 3.3 .....</b>	<b>23</b>
<b>3.2.1</b>	<b>Network performance standards .....</b>	<b>23</b>
3.2.1.1	<i>Voltage</i> fluctuations .....	23
3.2.1.2	Harmonic <i>voltage</i> distortion .....	23
3.2.1.3	Direct current injection .....	24
3.2.1.4	<i>Voltage</i> unbalance .....	24
3.2.1.5	Stability .....	24
3.2.1.6	Electromagnetic interference .....	24
3.2.1.7	Fault levels .....	24
3.2.1.8	Main switch .....	25
3.2.1.9	<i>Users' power quality monitoring equipment</i> .....	25
3.2.1.10	<i>Power system</i> simulation studies .....	25
3.2.1.11	Technical matters to be coordinated .....	25
<b>3.2.2</b>	<b>Provision of information .....</b>	<b>25</b>
<b>3.2.3</b>	<b>Protection requirements .....</b>	<b>25</b>
3.2.3.1	Transmission lines and other Plant operated at 66 kV and above .....	25
3.2.3.2	Interconnectors and ties operated at 33 kV and below .....	27
3.2.3.3	Feeders, reactors, capacitors and other plant operated at 33 kV and below .....	27
3.2.3.4	Transformers .....	27
3.2.3.5	Protection discrimination .....	28
3.2.3.6	Backup protection .....	28

3.2.3.7	Protection alarm requirements.....	29
3.2.3.8	Islanding of a User's facilities from the power system.....	29
3.2.3.9	Automatic reclose equipment .....	29
3.2.3.10	Maintenance of protection.....	30
<b>3.2.4</b>	<b>Design requirements for Users' substations.....</b>	<b>30</b>
<b>3.2.5</b>	<b>Remote monitoring and control requirements.....</b>	<b>31</b>
<b>3.2.6</b>	<b>Communications equipment.....</b>	<b>32</b>
<b>3.2.7</b>	<b>Secure electricity supplies.....</b>	<b>32</b>
<b>3.2.8</b>	<b>Load shedding facilities.....</b>	<b>32</b>
3.2.8.1	Load to be available for disconnection.....	33
3.2.8.2	Installation and testing of load shedding facilities.....	33
<b>3.2.9</b>	<b>Impact on power system performance.....</b>	<b>33</b>
<b>3.2.10</b>	<b>Safety criteria.....</b>	<b>34</b>
<b>3.2.11</b>	<b>Environmental criteria.....</b>	<b>34</b>
<b>3.2.12</b>	<b>Construction criteria.....</b>	<b>35</b>
3.2.12.1	Overhead lines.....	35
3.2.12.2	Underground cables.....	35
<b>3.3</b>	<b>Requirements for connection of Generators.....</b>	<b>35</b>
<b>3.3.1</b>	<b>Outline of requirements.....</b>	<b>35</b>
<b>3.3.2</b>	<b>Application of settings.....</b>	<b>36</b>
<b>3.3.3</b>	<b>Technical matters to be co-ordinated.....</b>	<b>37</b>
<b>3.3.4</b>	<b>Provision of information.....</b>	<b>38</b>
<b>3.3.5</b>	<b>Technical requirements.....</b>	<b>40</b>
3.3.5.1	Reactive Power Capability.....	42
3.3.5.2	Quality of Electricity Generated.....	42
3.3.5.3	Generating Unit Response to Frequency Disturbance.....	43
3.3.5.4	Generating System Response to Voltage Disturbances.....	44
3.3.5.5	Generating System Response to Disturbances Following Contingency Events.....	45
3.3.5.6	Quality of Electricity Generated and Continuous Uninterrupted Operation.....	50
3.3.5.7	Partial Load Rejection.....	50
3.3.5.8	Protection of Generating Units from Power System Disturbances.....	50
3.3.5.9	Protection Systems that Impact on Power System Security.....	52
3.3.5.10	Protection to Trip Plant for Unstable Operation.....	53
3.3.5.11	Frequency Control.....	53
3.3.5.12	Impact on Network Capability.....	55
3.3.5.13	Voltage and Reactive Power Control.....	55
3.3.5.14	Active Power Control.....	60
3.3.5.15	Inertia and Contingency FCAS.....	61

3.3.5.16 System Strength .....	61
3.3.5.17 Capacity Forecasting.....	62
<b>3.3.6 Monitoring and Control Requirements .....</b>	<b>64</b>
3.3.6.1 Remote Monitoring and Control.....	64
3.3.6.2 Communications Equipment .....	65
<b>3.3.7 Power station auxiliary supplies .....</b>	<b>65</b>
<b>3.3.8 Fault current.....</b>	<b>67</b>
<b>3.4 Requirements for connection of Small Generators .....</b>	<b>67</b>
3.4.1 Scope .....	67
3.4.2 Objectives.....	67
3.4.3 Categorisation of facilities.....	68
3.4.4 Information to be provided by a Small Generator .....	69
3.4.5 Safety and reliability.....	69
3.4.6 Small Generation Unit characteristics .....	70
3.4.7 Connection and operation.....	70
3.4.7.1 Main switch.....	70
3.4.7.2 Synchronising.....	70
3.4.7.3 Safe shutdown without external supply.....	71
3.4.8 Power quality and voltage change.....	71
3.4.9 Remote control, monitoring and communications .....	71
3.4.10 Protection.....	72
3.4.10.1 General.....	72
3.4.10.2 Pole slipping.....	74
3.4.10.3 Islanding protection and intertripping .....	74
3.4.10.4 Protection of Small Generator's equipment.....	74
3.4.11 Commissioning and testing.....	74
3.4.12 Technical matters to be coordinated .....	75
<b>3.5 Requirements for connection of Small Inverter Energy Systems .....</b>	<b>75</b>
3.5.1 Scope .....	75
3.5.2 Relevant standards .....	75
3.5.3 Metering installation .....	75
3.5.4 Safety.....	75

<b>3.5.5 Security of operational settings .....</b>	<b>76</b>
<b>3.5.6 Circuit arrangements.....</b>	<b>76</b>
3.5.6.1 Schematic diagram .....	76
<b>3.5.7 Protection.....</b>	<b>76</b>
3.5.7.1 Islanding protection .....	76
3.5.7.2 Synchronising .....	77
3.5.7.3 Reconnection to network.....	77
3.5.7.4 Overcurrent protection.....	77
3.5.7.5 Voltage limits .....	77
3.5.7.6 Frequency limits .....	77
<b>3.5.8 Commissioning and testing.....</b>	<b>78</b>
3.5.8.1 Commissioning.....	78
3.5.8.2 Re-confirmation of correct operation .....	78
<b>3.6 Requirements for connection of loads .....</b>	<b>78</b>
<b>3.6.1 Connection point for a User.....</b>	<b>79</b>
<b>3.6.2 Information .....</b>	<b>79</b>
<b>3.6.3 Design standards .....</b>	<b>79</b>
<b>3.6.4 Users' protection systems that impact on power system security .....</b>	<b>80</b>
<b>3.6.5 Thermal limits.....</b>	<b>80</b>
<b>3.6.6 Fault limits.....</b>	<b>80</b>
<b>3.6.7 Power factor requirements .....</b>	<b>80</b>
<b>4 POWER SYSTEM OPERATION SUPPORT .....</b>	<b>81</b>
4.1 [Deleted] .....	81
4.2 [Deleted] .....	81
4.3 Responsibilities.....	81
4.3.1 [Deleted] .....	81
4.3.2 Network Operator .....	81
4.3.3 [Deleted] .....	82
4.3.4 Users .....	82
4.4 [Deleted] .....	83
4.5 Voltage control .....	83



4.5.1 Network voltage control .....	83
4.5.2 [Deleted] .....	84
4.6 Network operations and power system security support .....	84
4.6.1 Network operations .....	84
4.6.2 Switching of reactive power facilities .....	84
4.6.3 [Deleted] .....	85
4.7 Other system security support measures .....	85
4.7.1 [Deleted] .....	85
4.7.2 [Deleted] .....	85
4.7.3 [Deleted] .....	85
4.7.4 [Deleted] .....	85
4.7.5 Managing electricity supply shortfall events .....	85
4.7.6 Directions by the Network Operator .....	85
4.7.7 Disconnection of generating units and/or associated loads .....	85
4.7.8 Emergency black start-up facilities .....	85
4.7.9 [Deleted] .....	85
4.7.10 Black system start-up .....	85
4.7.11 [Deleted] .....	85
4.8 Agent communications .....	85
4.9 Nomenclature standards .....	87
<b>5 TESTING OF PLANT AND EQUIPMENT .....</b>	<b>88</b>
5.1 Obligations to test plant or equipment .....	88
5.1.1 Network Operator obligations .....	88
5.1.2 Network Users' obligations .....	88
5.2 Routine testing of protection equipment .....	88
5.3 Testing by Users of their own plant requiring changes to agreed operation .....	89
5.4 Tests to demonstrate Generator compliance .....	90

5.4.1 Tests of generating units requiring changes to agreed operation .....	91
5.5 Power system tests .....	92
5.6 Compliance with the Network Technical Code .....	93
5.6.1 Right of inspection and testing .....	93
5.6.2 Generator compliance with the Code .....	94
5.7 Inspection of <i>plant</i> and equipment .....	95
5.7.1 Right of entry and inspection .....	95
<b>6 CONTROL AND PROTECTION SETTINGS .....</b>	<b>98</b>
6.1 Protection of power system equipment .....	98
6.1.1 Scope .....	98
6.1.2 Power system fault levels .....	98
6.1.3 Power system protection co-ordination .....	98
6.1.4 Short term thermal ratings of the power system .....	99
6.1.5 Availability of protection .....	99
6.1.6 Partial outage of power protection systems .....	99
6.1.6.1 Sensitivity of protection .....	100
6.1.6.2 Clearance of <i>small zone faults</i> .....	100
6.1.6.3 Clearance of faults under circuit breaker fail conditions .....	100
6.1.6.4 Details of proposed <i>Users' protection settings</i> .....	100
6.1.6.5 Coordination of <i>protection settings</i> .....	100
6.2 Power system stability co-ordination .....	101
<b>7 COMMISSIONING AND TESTING PROCEDURES .....</b>	<b>101</b>
7.1 Commissioning .....	101
7.1.1 Requirement to inspect and test equipment .....	101
7.1.2 Co-ordination during commissioning .....	101
7.1.3 Control and protection settings for equipment .....	102
7.1.4 Commissioning program .....	102
7.1.5 Commissioning tests .....	103
7.1.5.1 Commissioning of <i>protection</i> .....	104

<b>8</b>	<b>DISCONNECTION AND RECONNECTION OF PLANT AND EQUIPMENT</b>	<b>105</b>
8.1.1	Voluntary disconnection	105
8.1.2	Decommissioning procedures	105
8.1.3	Involuntary disconnection (refer also to clause 4.7)	105
8.1.4	Disconnection due to breach of a connection agreement	105
8.1.5	Disconnection during an emergency	105
8.1.6	Obligation to reconnect	105
<b>9</b>	<b>OPERATION OF GENERATORS CONNECTED TO THE NETWORK</b>	<b>108</b>
9.1	Power system security related market operations	108
9.1.1	Dispatch related limitations	108
9.1.2	[Deleted]	109
9.1.3	[Deleted]	109
9.2	Users' plant changes	109
9.3	Operation, maintenance and extension planning	109
9.4	[Deleted]	109
<b>10</b>	<b>[DELETED]</b>	<b>110</b>
<b>11</b>	<b>INFORMATION REQUIREMENTS FOR NETWORK CONNECTION</b>	<b>111</b>
11.1	Scope	111
11.2	Information to be provided by all <i>Network Users</i>	111
11.2.1	Information on connected plant	111
11.2.2	Details of proposed Users' protection	112
11.2.3	Requirements where a critical fault clearance time exists	112
11.3	[Deleted]	112
11.4	Information to be provided by <i>Users with Small Generators</i>	112
11.5	Information to be provided by <i>Users with Small Inverter Energy Systems</i>	112
11.6	Information to be provided by <i>Users with loads</i>	114

<b>12</b>	<b>TRANSITIONAL ARRANGEMENTS AND DEROGATIONS FROM THE CODE</b>	<b>115</b>
12.1	Purpose and application	115
12.2	Pre 1 April 2019 plant and equipment	116
12.3	Post 1 April 2019 plant and equipment	117
<b>PART C</b>	<b>NETWORK PLANNING CRITERIA</b>	<b>118</b>
<b>13</b>	<b>INTRODUCTION</b>	<b>119</b>
13.1	Network design philosophy	119
13.2	Amendments to the Planning Criteria	120
13.3	132 kV and 66 kV networks	120
13.4	Distribution networks	121
13.4.1	CBD area	121
13.4.2	Urban areas	121
13.4.3	Rural areas	121
13.4.4	Enhanced security of supply	121
13.4.5	Embedded generation	122
13.5	Process to assess the need for network reinforcement	122
13.6	The process of developing network concept plans	123
13.7	Planning Criteria	123
13.8	Network development	123
13.8.1	Annual planning review	124
13.8.2	Non network alternatives to network augmentation	124
13.9	Investment analysis and reporting	125
<b>14</b>	<b>SUPPLY CONTINGENCY CRITERIA</b>	<b>126</b>
14.1	Load areas	126
14.2	Supply contingencies	127
14.3	Equipment capacities	128
14.4	Forecast demand	128

14.5 Radial supply arrangements .....	128
14.6 Supply contingency criteria .....	129
<b>15 STEADY STATE CRITERIA .....</b>	<b>133</b>
15.1 Real and reactive generating limits .....	133
15.2 Steady state power <i>frequency voltage</i> .....	133
15.3 Thermal rating criteria .....	134
15.4 Fault rating criteria .....	135
<b>16 STABILITY CRITERIA .....</b>	<b>135</b>
16.1.1 Transient stability criteria .....	135
16.1.2 Rotor angle swing .....	137
16.1.3 Fault clearance time .....	137
16.1.4 Rotor angle swing and transient voltage dip .....	138
16.1.5 Pole slip protection .....	138
16.1.6 Small signal stability .....	138
16.2 Transient stability .....	139
16.2.1 Oscillation damping .....	139
16.2.2 Power system stabilisers .....	139
16.3 Voltage stability criteria .....	140
16.3.1 Voltage stability limits .....	140
16.3.2 Voltage collapse .....	140
16.3.3 Resonance conditions .....	140
16.3.4 Transient over-voltages .....	141
16.3.5 Temporary over-voltages .....	141
16.3.6 Transient voltage dip criteria (TVD) .....	141
16.4 Frequency stability criteria .....	141
<b>17 QUALITY OF SUPPLY CRITERIA .....</b>	<b>142</b>
17.1 Voltage fluctuation criteria .....	143

<b>17.1.1</b>	<b>Temporary over voltages</b>	<b>143</b>
<b>17.1.2</b>	<b>Step changes in voltage levels</b>	<b>144</b>
<b>17.2</b>	<b>Harmonic voltage and current distortion</b>	<b>145</b>
<b>17.2.1</b>	<b>Inter harmonic distortion</b>	<b>146</b>
<b>17.2.2</b>	<b>Direct current</b>	<b>146</b>
<b>17.3</b>	<b>Voltage unbalance</b>	<b>147</b>
<b>17.4</b>	<b>Electromagnetic interference</b>	<b>147</b>
<b>18</b>	<b>CONSTRUCTION STANDARDS CRITERIA</b>	<b>147</b>
<b>18.1</b>	<b>Conductor selection criteria</b>	<b>147</b>
<b>19</b>	<b>ENVIRONMENTAL CRITERIA</b>	<b>148</b>
<b>19.1</b>	<b>Social issues</b>	<b>149</b>
<b>19.2</b>	<b>Electromagnetic fields</b>	<b>149</b>
<b>19.3</b>	<b>Land-Use considerations</b>	<b>149</b>
<b>19.4</b>	<b>Noise</b>	<b>149</b>
<b>19.5</b>	<b>Visual amenity</b>	<b>149</b>
<b>PART D</b>	<b>ATTACHMENTS</b>	<b>151</b>
<b>Attachment 1</b>	<b>Glossary of Terms</b>	<b>151</b>
<b>Attachment 2</b>	<b>Rules of interpretation</b>	<b>169</b>
<b>Attachment 3</b>	<b>Technical details for connection and access</b>	<b>170</b>
<b>A3.1</b>	<b>Introduction</b>	<b>170</b>
<b>A3.2.1</b>	<b>Preliminary system planning data</b>	<b>170</b>
<b>A3.2.2</b>	<b>Registered system planning data</b>	<b>170</b>
<b>Schedule S3.1</b>	<b>Generating unit design data</b>	<b>172</b>
<b>Schedule S3.2</b>	<b>Generating unit setting data</b>	<b>180</b>
<b>Schedule S3.3</b>	<b>Generator data for small generating systems</b>	<b>181</b>
<b>Schedule S3.4</b>	<b>Technical data for Small Inverter Energy Systems</b>	<b>182</b>
<b>Schedule S3.5</b>	<b>Network and plant technical data</b>	<b>183</b>
<b>Schedule S3.6</b>	<b>Network plant and apparatus setting data</b>	<b>185</b>

<del>Schedule S3.7 Load characteristics at connection point</del>	<del>185</del>
<del>Schedule S4 Grace periods for purposes of clause 12.3</del>	<del>187</del>
<del>Attachment 4 [Deleted]</del>	<del>188</del>
<del>Attachment 5 Test schedule</del>	<del>191</del>





## INTRODUCTION

### 1.1 Introduction

*Transmission and distribution networks* owned by *Power and Water* cover the major centres of the Northern Territory. ~~The legislated Third Party Access regime~~ *The NT NER* gives rights to private *Generators* and *load customers* to use the *networks* to enable contracted trade between *Generator Users* and *Customer Users*.

### Structure of this document

This document comprises the following parts:

- Part A** The legislative requirements that apply to *Power and Water Networks* and to *customers* seeking access to its regulated electrical *networks*.
- Part B** The ***Network Technical Code*** sets out technical requirements designed to ensure that the *network* and the *customer* installations and equipment *connected* to the *network* may be operated and maintained in a secure and *reliable* manner.
- Part C** The ***Network Planning Criteria*** are designed to ensure that new *loads* and *Generators connected* to the *network* do not compromise the security and *reliability of supply* to all ~~network~~*Network Users*.
- Part D** Attachments, including, amongst other things, a Glossary of terms and Schedules of the information that is required to be provided by *customers* seeking to *connect* to *Power and Water's* regulated *networks*.

The *Network Technical Code* and *Network Planning Criteria* apply to *Power and Water's* regulated *networks*.

### Document nomenclature

Terms defined in the Glossary of this document are *italicised*.

Explanatory and contextual material is included in boxed sections that do not form part of the *Network Technical Code* or *Network Planning Criteria*.

### Document amendment

This document is subject to amendment in accordance with the legislative provisions and users of the document are advised to obtain the current version from the Manager Regulation, Pricing and Economic Analysis, at the following address:

Power and Water Corporation

Level 7, Mitchell Centre, Darwin NT 0800  
GPO Box 1921, Darwin NT 0801

Telephone: (08) 8985 8431

Facsimile: (08) 8923 9527

The document is also available from *Power and Water's* Internet site at the following address:  
<http://www.powerwater.com.au/>.

Field Code Changed

## Part A Legislative requirements

This document is prepared pursuant to the Northern Territory *Electricity Networks (Third Party Access) Act (TPA Act)*, as in force at 1 August 2012-*Reform (Administration) Regulations*, as in force at 1 July 2019, which require Power and Water as a network provider to publish a Network Technical Code.

The Northern Territory Electricity Networks (Third Party Access) Code (Network Access Code) is established in Part 2 of the TPA Act and the accompanying Schedule. The Network Access Code sets out:

- (a) The terms and conditions under which access to an electricity network is to be granted to third party Users and the associated obligations both on the network provider and on network Users;
- (b) The framework within which Access Agreements are to be negotiated and implemented; and
- (c) The mechanism for resolving access disputes.

Clause 9, sub-clause (2) of the Network Access Code requires the network provider to prepare and make publicly available a Network Technical Code and Network Planning Criteria.

**Clause 30, sub-clause (2) of the Network Access Code** **Network Technical Code**

Regulation 25(4) of the *Electricity Reform (Administration) Regulations* states that all network Users shall comply with the Network Technical Code regarding connection to and use of the electricity network.

1.1.1.1 — Network Technical Code

Schedule 1, clause 1 of the Network Access Code lists must cover the requirements of the Network Technical Code. This Network Technical Code sets out the following matters. The relevant clauses of this document are also referenced in Table 1, set out in Schedule 2, other than:

Table 1 (a) matters dealt with in the National Electricity (NT) Rules; or

(b) matters appropriately dealt with in the System Control Technical Code.

Figure 1 sets out the matters listed in Schedule 2, together with their location in this Code or other instrument.

**Figure 1 – Requirements of the Network Technical Code**

Code requirement	clause
(a) <del>(a)</del> performance standards in respect of service quality parameters in relation to the electricity network;	<del>202</del>
(b) <del>(b)</del> the technical requirements that apply to the design or operation of plant or equipment connected to the electricity network;	<del>303</del>
(c) <del>(c)</del> requirements relating to the operation of the electricity network (including the operation of the network in emergency situations);	<del>404</del>
(d) <del>(d)</del> obligations to test plant or equipment in order to demonstrate compliance with the Network Technical Code;	<del>5.1.1(a)5</del>
(e) <del>(e)</del> procedures that apply if the network provider believes that an item of plant or equipment does not comply with the requirements of the Network Technical Code;	<del>5.6</del> 5.6
(f) <del>(f)</del> requirements relating to the inspection of plant or equipment connected to the electricity network;	<del>5.7</del> 5.7
(g) <del>(g)</del> requirements that relate to control and protection settings for plant or equipment connected to the electricity network;	<del>606</del>
(h) <del>(h)</del> procedures that apply in the case of commissioning and testing of new plant or equipment connected to the electricity network;	<del>707</del>
(i) <del>(i)</del> — aside from matters appropriately dealt with in the System Control Technical Code, procedures that apply to the disconnection and reconnection of plant or equipment from the electricity network;	<del>808</del>
(j) <del>(j)</del> — aside from matters appropriately dealt with in the System Control Technical Code, procedures relating to the operation of <i>Generating Units</i> generating units connected to the electricity network (including the giving of <i>dispatch</i> instructions and compliance with those instructions);	<del>909</del>

Code requirement	clause
(k) <del>(k)</del> metering requirements in relation to <i>connections</i> <del>and</del>	<del>10</del> NT NER Chapter 7A
<del>(j)</del> the information required to be provided to the Network Operator in relation to the operation of plant or equipment connected to the electricity network at a connection and how	<del>11</del> 11
(l) <del>and</del> when that information is to be provided.	



## Network Planning Criteria

Schedule 1, clause 2 of the [Network Access Electricity Reform \(Administration\) Regulations](#) requires that the *Network Planning Criteria* must be consistent with the [Network Technical Code](#), and lists the matters that shall be contained in the *Network Planning Criteria*. The relevant clauses of this document are referenced in [Table 2](#) [Figure 2](#) [Figure 2](#).

**Table 2** [Figure 2](#) – Requirements of the Network Planning Criteria

Planning criterion	clause
(a) <del>(a)</del> contingency criteria;	<del>14.6</del> <a href="#">14.6</a>
(b) <del>(b)</del> steady-state criteria including:	<del>15</del> <a href="#">15</a>
(i) <del>(i)</del> voltage limits;	<del>15.2</del> <a href="#">15.2</a>
(ii) <del>(ii)</del> thermal rating criteria; and	<del>15.3</del> <a href="#">15.3</a>
(iii) <del>(iii)</del> fault rating criteria;	<del>15.4</del> <a href="#">15.4</a>
(c) <del>(c)</del> stability criteria including:	<del>16</del> <a href="#">16</a>
(i) <del>(i)</del> transient stability criteria; and	<del>16.1</del> <del>16.1</del> <del>16.1</del> <a href="#">16.1</a>
(ii) <del>(ii)</del> voltage stability criteria;	<del>16.2</del> <del>16.3</del> <del>16.2</del> <a href="#">16.2</a>
(d) <del>(d)</del> quality of supply criteria including:	<del>17</del> <a href="#">17</a>
(i) <del>(i)</del> voltage fluctuation criteria;	<del>17.1</del> <a href="#">17.1</a>
(ii) <del>(ii)</del> harmonic voltage criteria;	<del>17.2</del> <del>17.2</del> <a href="#">17.2</a>
(iii) <del>(iii)</del> harmonic current criteria;	<del>17.2</del> <del>17.2</del> <a href="#">17.2</a>
(iv) <del>(iv)</del> voltage unbalance criteria; and	<del>17.3</del> <a href="#">17.3</a>
(v) <del>(v)</del> electro-magnetic interference criteria;	<del>17.4</del> <a href="#">17.4</a>
(e) <del>(e)</del> construction standards criteria; and	<del>18</del> <a href="#">18</a>
(f) <del>(f)</del> environmental criteria.	<del>19</del> <del>18</del> <del>19</del> <a href="#">18</a> , <a href="#">19</a>

# Part B - Network Technical Code

## 1 Application

*In this Network Technical Code (Code), unless otherwise stated, a reference to Network Operator or Power System Controller refers to the appropriate business unit of the Power and Water Corporation.*

## 1 INTRODUCTION

*In this Network Technical Code (Code), unless otherwise stated, a reference to Network Operator or Power System Controller refers to the appropriate business unit of the Power and Water Corporation.*

### 1.21.1 Persons to whom the Code applies

- (a) *Power and Water Corporation* in its role as the operator of the *electricity network (Network Operator)*;
- (b) *Power and Water Corporation* in its role as the *Power System Controller*;
- (c) Every person who seeks access to spare capacity or new capacity or makes an *Access Application* in order to establish a *connection* or modify an existing *connection*; and
- (d) Every person to whom access to the *electricity network* is made available (including, without limitation, the *Power and Water Corporation* in its role as a trader of electricity and every person with whom the *Network Operator* has entered into an *Access Agreement*).

### 1.31.2 Plant and equipment to which the Code applies

- (a) Equipment installed in the *Network Operator's electricity networks*; and
- (b) Equipment installed by *Users* who are *connected* (either directly or indirectly) to the *electricity networks*.

### 1.41.3 Other documents

- (a) This *Code* and the Network Planning Criteria at Part C shall be read in conjunction with the following *Power and Water Corporation* documents:
  - (1) Service Rules;
  - (2) Installation Rules;
  - (3) Metering Manual;
  - (4) Network Policies and Safe Working Procedures; and
  - (5) System Control Technical Code.



#### 1.51.4 Commencement

- (a) Version 1 of the *Code* came into operation on 1 April 2000 ("*Code commencement date*").
- (b) Amendment 2.0 of the *Code* was entitled the Network Connection Technical Code and was issued in April 2003.

~~(c)~~ Amendment 3.1 of the *Network Technical Code* and *Network Planning Criteria* took effect from December 2013.

~~(e)~~(d) This ~~Version 3.1~~Version 4.0 amendment ~~[XX]~~ of the *Network Technical Code* and *Network Planning Criteria* has been made in accordance with the legislative provisions and takes effect from ~~December 2013~~[insert date of publication].

## 1-61.5 Interpretation

- (a) In this *Code*, words and phrases are defined in Attachment 1 and have the meanings given to them in Attachment 1, unless the contrary intention appears.
- (b) This *Code* shall be interpreted in accordance with the rules of interpretation set out in Attachment 2, unless the contrary intention appears.

### 1-61.5.1 Conflict between Technical Codes

- (a) A conflict exists when there is a difference in substance or interpretation of the provisions contained in the *Network Technical Code* and provisions contained in the *System Control Technical Code* relating to *power system*:
  - (1) *reliability*;
  - (2) *safety*;
  - (3) *security*;
  - (4) *operational issues*; or
  - (5) *procedures*.
- (b) In the event of a conflict and to the extent of any inconsistency, the provisions of the *System Control Technical Code* will prevail over the *Network Technical Code*.
- (c) Where a conflict cannot be resolved under sub clause (b), consultations will take place between:
  - (1) the *Power System Controller*;
  - (2) the *Network Operator*; and
  - (3) any affected *Users*.
- (d) An affected *User* is a *User* who provides evidence to the *Power System Controller* and in the opinion of the *Power System Controller* the evidence proves the *User's* sufficient interest in consultations.

## 1-71.6 Dispute resolution

- (a) Should a dispute arise between a *User* and the *Network Operator* concerning this *Code*, the *Network Operator* shall negotiate with the *User* to determine mutually acceptable agreed outcomes.
- (b) If an agreement cannot be reached between these two parties, the Utilities Commissioner shall arbitrate the dispute.

## 1.8.1.7 Obligations

### 1.8.1.7.1 Obligations of the Network Operator

- ~~(a)~~—The *Network Operator* shall comply with the *power system* performance and
- (a) *quality of supply* standards:
- (1) described in this *Code*; and
  - (2) in accordance with any ~~*Access Agreement*~~*connection agreement* with a *User*.
- (b) The *Network Operator* shall:
- (1) ensure that to the extent that a *connection point* relates to the *electricity network*, every arrangement for *connection* with a *User* complies with all relevant provisions of this *Code*;
  - (2) permit and participate in inspection and testing of *facilities* and equipment in accordance with clause ~~5-1.1(a)5-1;~~
  - (3) permit and participate in commissioning of *facilities* and equipment which is to be *connected* to its *network* in accordance with clause ~~7-07;~~
  - (4) advise a *User* with whom there is ~~an *Access Agreement*~~*a connection agreement* of any expected interruption characteristics at a *connection point* on or with its *network* so that the *User* may make alternative arrangements for *supply* during such interruptions, including negotiating for an alternative or backup *connection*; and
  - (5) use its reasonable endeavours to ensure that modelling data used for planning, design and operational purposes is complete and accurate and order tests in accordance with clause ~~5-5-5.5~~ where there are reasonable grounds to question the validity of data.
- (c) The *Network Operator* shall arrange for:
- (1) management, maintenance and operation of the *electricity network* such that in the *satisfactory operating state*, electricity may be transferred continuously at a *connection point* up to the *agreed capability*;
  - (2) management, maintenance and operation of its *network* to minimise the number of interruptions to *agreed capability* at a *connection point* on or with that *network* by using *good electricity industry practice*; and
  - (3) restoration of the *agreed capability* as soon as reasonably practical following any interruption at a *connection point* on or with its *network*.

### 1.8.21.7.2 Obligations of Users

- (a) All *Users* shall maintain and operate (or ensure their authorised *representatives* maintain and operate) all equipment that is part of their *facilities* in accordance with:
- (1) relevant laws;

- (2) the requirements of this Code; and
  - (3) *good electricity industry practice* and applicable *Australian Standards*.
- (b) Each *User* shall:
- (1) comply with the reasonable requirements of the *Network Operator* in respect of design requirements of equipment proposed to be *connected* to the *network* of the *Network Operator* in accordance with clause ~~3.03~~;
  - (2) permit and participate in inspection and testing of *facilities* and equipment in accordance with clause ~~5.4.1.1(a)5.4.1~~;
  - (3) permit and participate in commissioning of *facilities* and equipment which is to be *connected* to a *network* location for the first *time* in accordance with clause ~~7.07~~;
  - (4) operate *facilities* and equipment in accordance with any reasonable *direction* given by the *Network Operator* and *Power System Controller*; and
  - (5) give notice of intended voluntary *disconnection* in accordance with clause ~~8.08~~.

#### ~~1.8.3~~1.7.3 Obligations of Generator Users

- (a) A *Generator User* shall comply at all times with applicable requirements and conditions of *connection* for ~~Generation Units~~*generating units*:
- (1) as set out in ~~clauses 3.2~~ clause ~~3.3~~ and ~~3.3~~; and
  - (2) in accordance with any ~~Access Agreement~~*connection agreement* with the *Network Operator*.

#### ~~1.8.4~~1.7.4 Obligations of Generator Users with ~~Small Generators~~*small generating systems*

- (a) A *Generator User* with a *Small Generator* shall comply at all times with applicable requirements and conditions of *connection* for ~~Small Generation Units~~*a small generating system*:
- (1) as set out in clauses ~~3.2~~ ~~3.2~~ and ~~3.4~~ ~~3.4~~; and
  - (2) in accordance with any ~~Access Agreement~~*connection agreement* with the *Network Operator*.

#### ~~1.8.5~~1.7.5 Obligations of Users with Small Inverter Energy Systems

- (a) A *User* with a *Small Inverter Energy System* shall comply at all times with applicable requirements and conditions of *connection* for *Small Inverter Energy Systems*:
- (1) as set out in clauses ~~3.2~~ and ~~3.5~~ ~~3.2~~ and ~~3.5~~; and
  - (2) in accordance with any ~~Access Agreement~~*connection agreement* with the *Network Operator*.

### **1.8.61.7.6 Obligations of Users with loads**

- (a) Each *User* with a *load* shall ensure that all *facilities* which are owned, operated or controlled by it and are associated with a *connection point* at all times comply with applicable requirements and conditions of *connection for loads*:
- (1) as set out in clauses ~~3.2 and 3.6~~ 3.2 and 3.6; and
  - (2) in accordance with any ~~Access Agreement~~ connection agreement with the *Network Operator*.

### **1.8.71.7.7 Variations and exemptions from the Code**

- ~~(a)~~ Various clauses throughout this *Code* permit variations or exemptions from
- (a) *Code* requirements to be granted to a *User* by reference to terms that include:
- (1) the requirements may be varied, but only with the agreement of the *Network Operator*;  
~~*Network Operator*;~~
  - (2) unless otherwise agreed by the *Network Operator*;
  - (3) unless otherwise agreed; and
  - (4) except where specifically varied in ~~an Access Agreement~~ a connection agreement.
- (b) In all cases the *Network Operator* will notify in writing any such variation or exemption to *Users*.

### **1.91.8 Amendments to the Code**

- (a) Any ~~System Participant~~ *User* may propose an amendment to the *Code*.
- (b) A proposal to amend the *Code* shall be made in writing by the ~~System Participant~~ *User* to the *Network Operator* and shall be accompanied by:
- (1) the reasons for the proposed amendment to the *Code*; and
  - (2) an explanation of the effect on ~~System Participants~~ *Users* of the proposed amendment to the *Code*.
- (c) ~~The~~ Subject to paragraph (f) below, the *Network Operator* shall review the proposed amendment to the *Code* and within 30 days advise the ~~System Participant~~ *User* or electricity entity:
- (1) whether the proposed amendment to the *Code* is accepted or rejected; and
  - (2) the reasons for the acceptance or rejection of the proposed amendment to the *Code*.
- (d) The 30 day period in clause 1.9(c) is extended as reasonably required to allow any public consultation or consultation with the Utilities Commission required under the legislative provisions.

~~(e)~~(e) The *Network Operator* shall review the operation of the *Code* at intervals of no more than 5 years and may seek submissions from ~~*System Participants*~~*Users* and the Utilities Commission during the course of the review.

~~(e)~~(f) Before amending the *Code* or *Network Planning Criteria* in a material way, the *Network Operator* must consult the Utilities Commission and undertake consultation in accordance with the legislative provisions.

## 2 Network performance standards

Note - Australian Standards are defined in Attachment 1 as the most recent edition of a standard publication by Standards Australia. Historical standards referred to in this Code should be interpreted accordingly.

### 2.1 Introduction

This clause ~~2.02~~ describes the technical performance parameters and standards for the power system. These standards provide the basis for the technical requirements for equipment connected to the electricity network, covered in clause ~~303~~.

### 2.2 Power system operating frequency

- (a) The nominal operating frequency of the power system is 50-Hz.
- (b) The accumulated synchronous time error shall be less than 15 seconds for 99% of the time.

#### 2.2.1 Frequency range under normal operating conditions

- (a) The frequency ranges under normal operating conditions for the Northern Territory regulated networks are set out in ~~Table 3~~ ~~Figure 3~~ ~~Figure 3~~.

~~Table 3~~ ~~Figure 3~~ – Frequency range under normal operating conditions

Power and Water system	Frequency range
Darwin – Katherine	50-Hz $\pm$ 0.2-Hz
Alice Springs	50-Hz $\pm$ 0.2-Hz
Tennant Creek and isolated, regional distribution networks	50-Hz $\pm$ 0.4-Hz

#### 2.2.2 Frequency range under abnormal operating conditions

- (a) To cover for the loss of a ~~Generation Unit~~ ~~generating unit~~ from the power system two measures will be applied to arrest the fall in frequency following the loss of ~~Generation~~ ~~generation~~ and to return the frequency to within normal operating levels as specified in clause ~~2.2.4~~ ~~2.2.1~~:
  - (1) utilisation of available spinning reserve or C-FCAS as applicable in each regulated power system, under the direction of the Power System Controller and
  - (2) ~~disconnection~~ of system load manually or by means of automatic ~~protection~~ ~~protection~~.
- (b) Under abnormal operating conditions, the network frequency may vary between 47-Hz and 52-Hz.

(b1) In the case of operation between 47 Hz and 52 Hz, the stabilisation time is 10 minutes, where stabilisation time means:

the longest time allowable for the frequency of the power system to remain outside the normal operating frequency band, for any condition (including an "island" condition) in the frequency operating standards that apply to each region.

- (c) In the case of operation below 47-Hz but at or above 45-Hz, all *Generation Units* shall remain connected to the *Network Operator's network* for a period of at least 2 seconds.
- (d) With sustained operation below 47-Hz, *under frequency load shedding* schemes may *disconnect load* on the *network* to restore *frequency* to the normal operating range, in accordance with clause 3.2.8.1-3.2.8.1.



- (e) *Frequency stability shall be satisfied under all credible power system load and generation patterns, and the most severe credible contingencies of transmission plant including the loss of interconnecting plant leading to the formation of islands within the power system.*
- (f) Each island in the power system that contains generation shall have sufficient load shedding facilities in accordance with clause ~~16-16~~ of the *Network Planning Criteria* to aid recovery of frequency to the range 49.5-Hz to 50.5-Hz in the network.
- (g) When islanding occurs the *Power System Controller* will determine which power station or ~~Generation Units~~*generating unit* in each isolated system will regulate the frequency in that system.

## 2.3 Power frequency voltage levels

### 2.3.1 Steady state voltage levels

- (a) The requirements for steady-state voltage levels are set out in clause ~~15.2~~15.2 of the *Network Planning Criteria*.
- (b) The specifications for voltage levels in clause ~~15.2~~15.2 shall apply in this Code.
- (c) Users' equipment shall be designed to withstand these voltage levels.
- (d) The power frequency voltage may vary outside the ranges set out in this clause ~~2.3.1~~2.3.1 as a result of a *non-credible contingency event*.

#### ~~2.3.1~~ Temporary over-voltages

### 2.3.2 Temporary over-voltages

- (a) As a consequence of a *credible contingency event*, the voltage of supply at a connection point shall not rise above its *normal voltage* by more than the percentage specified in clause ~~17.1.1~~17.1.1 of the *Network Planning Criteria*.
- (b) Users' equipment shall also be designed to withstand these voltage levels.
- ~~(a)~~ As a consequence of a *contingency event*, the voltage of supply at a connection point could fall to zero for any period.

### 2.3.3 Step changes in voltage levels

#### ~~2.3.2~~ Step changes in the power system voltage levels may take place due to switching operations on the network. Step changes in voltage levels

~~Step changes in the power system voltage levels may take place due to switching operations on the network.~~ The step changes in voltage shall not exceed the limits set out in clause ~~17.1.2~~17.1.2 of the *Network Planning Criteria*.

## 2.4 Quality of supply

### 2.4.1 Voltage fluctuations

#### ~~2.4.1~~ Voltage fluctuations

*A voltage disturbance is where the voltage shape is maintained but the voltage magnitude varies and may fall outside the steady state supply voltage range set out in clause 15.2 of the Network Planning Criteria. Short duration voltage disturbances of durations of up to one minute are termed voltage sags and swells.*

The ENA publication *Customer Guide to Electricity Supply* contains information on the typical *voltage sags* experienced on Australian *electricity networks* and how *customers* can mitigate the risks of equipment maloperation because of sags.

Rapid *voltage* fluctuations cause *changes* to the luminance of lamps, which can create the visual phenomenon termed flicker.

A *voltage* disturbance is where the *voltage* shape is maintained but the *voltage* magnitude varies and may fall outside the steady state *supply voltage* range set out in clause 15.2 of the *Network Planning Criteria*. Short duration *voltage* disturbances of durations of up to one minute are termed *voltage sags* and swells.

The ENA publication *Customer Guide to Electricity Supply* contains information on the typical *voltage sags* experienced on Australian *electricity networks* and how *customers* can mitigate the risks of equipment maloperation because of sags.

Rapid *voltage* fluctuations cause *changes* to the luminance of lamps, which can create the visual phenomenon termed flicker.

(a) Under normal operating conditions, fluctuations in *voltage* on the *network* should be less than the “compatibility levels” defined in Table 1 of *Australian Standard AS/NZS 61000.3.7 (2001)*.

~~(a)~~ To facilitate the application of this standard *Power and Water* shall establish

(b) “planning levels” for its *networks*, as provided for in the *Australian Standard*.

~~(c)~~ The *Network Operator* must allocate emission limits to a *connection applicant* that are no more onerous than the lesser of the acceptance levels determined in accordance with either of the stage 1 or the stage 2 evaluation procedures defined in *AS/NZS 61000.3.7:2001*.

## **2.4.12.4.2 Harmonic distortion**

### **2.4.12.4.2.1 Harmonic voltage distortion**

(a) Under normal operating conditions, the harmonic *voltage* in the *network* shall be less than the “compatibility levels” defined in Table 1 of *Australian Standard AS/NZS 61000.3.6 (2001)*.

(b) To facilitate the application of this standard *Power and Water* shall establish “planning levels” of harmonic distortion for its *networks* as provided for in the *Australian Standard*.

(c) Planning levels for harmonic *voltage* distortion are specified in clause ~~17~~17 of the *Network Planning Criteria*.

~~(d)~~ The *Network Operator* must allocate emission limits to a *connection applicant* that are no more onerous than the lesser of the acceptance levels determined in accordance with either of the stage 1 or the stage 2 evaluation procedures defined in *AS/NZS 61000.3.6:2001*.

#### 2.4.1-22.4.2.2 Non-integer harmonic distortion

~~Inter-harmonic or non-integer harmonic distortion may arise from large converters or power electronics equipment with Pulse Width Modulation (PWM) converters interfacing with the power system.~~

Inter-harmonic or non-integer harmonic distortion may arise from large converters or power electronics equipment with Pulse Width Modulation (PWM) converters interfacing with the power system.

- (a) Under normal operating conditions, the emission levels for inter-harmonic *voltage* in the *network* shall be less than the levels defined in section 9 of *Australian Standard AS/NZS 61000.3.6 (2001)*.
- (b) To facilitate the application of this standard *Power and Water* shall establish “planning levels” of inter-harmonic distortion for its *networks* as provided for in the *Australian Standard AS/NZS 61000.3.6 (2001)*.
- (c) Planning levels for inter-harmonic *voltage* distortion are specified in clause ~~17~~17 of the *Network Planning Criteria*.

~~(d) The Network Operator must allocate emission limits to a connection applicant that are no more onerous than the lesser of the acceptance levels determined in accordance with either of the stage 1 or the stage 2 evaluation procedures defined in AS/NZS 61000.3.6:2001.~~

#### ~~2.4.1.3~~ 2.4.2.3 Voltage notching

~~Voltage notching may also arise from large convertors or power electronics equipment with Pulse Width Modulation (PWM) converters interfacing with the power system.~~

~~Voltage notching may also arise from large convertors or power electronics equipment with Pulse Width Modulation (PWM) converters interfacing with the power system.~~

Voltage notching caused by a User's facilities is acceptable provided that:

- ~~(a)~~ the limiting values of harmonic voltage distortion as described in clause (a) ~~2.4.2.1-2.4.2.1~~ 2.4.2.1 are not exceeded;
- (b) the average of start notch depth and end notch depth shall not exceed 20% of the nominal fundamental peak voltage; and
- (c) the peak amplitude of oscillations due to commutation at the start and end of the voltage notch shall not exceed 20% of the nominal fundamental peak voltage.

#### ~~2.4.1.4~~ 2.4.2.4 Harmonic current distortion

- (a) The harmonic voltage distortion limits of clause ~~2.4.2-2.4.2~~ 2.4.2 apply to each phase and are not to be exceeded by a User injecting harmonic currents at any of its connection points.
- (b) Any induced noise interference to telecommunications lines by a User's load due to harmonic currents is not acceptable and the User is required to reduce the level of harmonic currents so as to contain such interference to limits considered acceptable by the telecommunication Network Operator.
- ~~(b)~~ The User's load shall not cause any harmonic resonance in other Users' systems or the Network Operator's network.

#### ~~2.4.2.2~~ Direct current

#### 2.4.2.5 Direct current

- (a) Users' plant and equipment shall comply with the requirements on direct current components as stipulated in clause 3.12 of Australian Standard AS/NZS 3100:2009. In particular, the direct current in the neutral caused by the Users' plant and equipment shall not exceed 120mA.h per day.
- (b) Users shall ensure that all their plant and equipment is designed to withstand without damage or reduction in life expectancy the limits as specified in this clause ~~2.4.2.5-2.4.2.5~~ 2.4.2.5.

- (c) Responsibility of the *Network Operator* for direct current in the neutral outside the limits specified in this clause ~~2.4.2.5~~2.4.2.5 shall be limited to direct current in the neutral caused by *network* assets.
- (d) A *User* whose *plant* is identified by the *Network Operator* as not performing to the standards specified in this clause ~~2.4.2.5~~2.4.2.5 shall take such measures as may be necessary to meet *Australian Standard AS/NZS-3100:2009*.

#### 2.4.2 Voltage Unbalance

### 2.4.3 Voltage unbalance

- (a) For normal system operation and for planned system *outages*, the average *voltage unbalance* measured over a half hour at a *connection point* should not exceed the amount shown in ~~Table 4~~ *Figure 4*.

~~Table 4~~ *Figure 4* - Voltage unbalance limits

Nominal supply voltage	Maximum negative sequence voltage (% of nominal voltage)
132 kV	1.0
11-66 kV	1.5
Low voltage	2.0

An increase in the negative phase sequence *voltage* of up to 50% of the above is permissible for an aggregate of up to 5 minutes in any 30-minute period.

## 2.5 Electromagnetic interference

Electromagnetic interference caused by equipment forming part of the *transmission* and *network* shall not exceed the limits set out in Tables 1 and 2 of *Australian Standard AS2344* (1997).

## 2.6 Stability

#### 2.6.1 Transient rotor angle stability

~~All Generation Units connected to the transmission system and Generation Units within power stations that are connected to the network and that are classified as large generators shall remain in synchronism following a credible contingency event.~~

#### 2.6.2 Dynamic stability

~~System oscillations originating from system electromechanical characteristics, electromagnetic effect or non-linearity of system components, and triggered by any small disturbance or large disturbance in the power system, shall remain within the small disturbance rotor angle stability criteria and the power system shall return to a stable operating state following the disturbance. The small disturbance rotor angle stability criteria are set out below.~~

### 2.6.1 [Deleted]

### 2.6.2 Dynamic stability

System oscillations originating from system electromechanical characteristics, electromagnetic effect or non-linearity of system components, and triggered by any small disturbance or large disturbance in the power system, shall remain within the small disturbance rotor angle stability criteria and the power system shall return to a stable operating state following the disturbance. The small disturbance rotor angle stability criteria are set out below.

- (a) All electromechanical oscillations resulting from any small or large disturbance in the *power system* shall be well damped and the *power system* shall return to a stable operating state.
- (b) The damping ratio of electromechanical oscillations shall be at least 0.1.
- (c) For electromechanical oscillations as a result of a small disturbance, the damping ratio of the oscillation shall be at least 0.5.
- (d) In addition to the requirements of clauses ~~2.6.2(2.6.2(a))~~ and ~~2.6.2(2.6.2(b))~~, the halving time of any electromechanical oscillations shall not exceed 5 seconds.  
~~time of any electromechanical oscillations shall not exceed 5 seconds.~~



- (e) If oscillations do not comply with clause ~~2.6.2~~(2.6.2)(d), then appropriate measures shall be taken to *change the power system configuration and/or ~~Generation~~generation dispatch* so as to eliminate such oscillations. Such measures shall be taken by automatic means.
- (f) *Users* who may cause subsynchronous or supersynchronous resonance oscillations shall provide appropriate measures at the planning and design stage to prevent the introduction of this problem to the *Network Operator's power system* or other *Users'* systems.

### ~~2.6.1~~2.6.3 Short term voltage stability

- (a) Short term *voltage* stability is concerned with the *power system* surviving an initial disturbance and reaching a satisfactory new steady state.
- (b) Stable *voltage control* shall be maintained following the most severe *credible contingency event*.

## 2.7 Contingency criteria for the network

~~To a great extent, the contingency criteria used for the design of the network will determine the inherent reliability of customer supply. These criteria apply to the shared network, and not to customer connections.~~

To a great extent, the contingency criteria used for the design of the network will determine the inherent reliability of customer supply. These criteria apply to the shared network, and not to customer connections.

- ~~(b)~~ — The contingency levels to which the *network* and sub-clauses of the *network*
  - (a) are designed are set out in clause ~~14-14~~14 of the *Network Planning Criteria*.
  - (b) The contingency criteria in this clause ~~2.7-2.7~~2.7 apply only to the *electricity networks* and not to *customer connections* to the *network*.
  - (c) The contingency criteria for a sub-clause of the *network* may be varied by *Power and Water* following a risk/benefit analysis and other considerations such as capital investment priorities, social needs, the environment and land use.
  - (d) Connection assets will be designed in accordance with a *User's* requirements and a ~~network~~*Network* *User* may choose a design configuration having a greater or lesser level of security for its dedicated *connection* to the *shared network*, subject to the approval of *Power and Water*.
  - (e) The contingency criteria to which the *network* has been designed shall be taken into account when assessing the impact of a *User's* installation on other *Users*, or the *power system*.

## 2.8 Equipment fault level ratings

- (a) The *Network Operator* shall specify the minimum fault level ratings of equipment connected to the *network*.

(b) Unless otherwise agreed by the *Network Operator*, the equipment fault level ratings specified in clause ~~15.4~~15.4 of the *Network Planning Criteria* shall apply.

## 2.9 Protection arrangements

### 2.9.1 Users' obligation to provide adequate protection

#### 2.9.1.1 Safety of people

It is the *User's* responsibility to provide adequate *protection* (at the *User's* discretion) of all *User* owned *plant* to ensure the safety of the public and personnel, and to minimise damage.

#### 2.9.1.2 System reliability and integrity

- (a) The *Network Operator* and *Users* shall ensure that any new equipment *connected* to any part of the system is protected in accordance with the requirements of clause ~~2.9.02.9~~.
- (b) Where the *connection* of new equipment would affect *critical fault clearance times*, the *protection* of both new and existing equipment throughout the *power system* shall meet the new *critical fault clearance times*.
- (c) Where existing *protection* would not meet the new *critical fault clearance times*, that *protection* shall be upgraded.
- (d) *Fault clearance time* requirements may not be established until all new *plant* data is available and the detailed design of a *User's connection* or *network* reinforcement has commenced.
- (e) All faults of any type shall be cleared within the times specified in clause ~~2.9.5~~ 2.9.5 unless it can be established by the *Network Operator* that a longer *clearance time* would not result in the *network* failing to meet the performance standards set out in clause ~~2.02~~.

#### 2.9.1.3 Minimum standard of protection equipment

*Protection systems* shall be designed, installed and maintained in accordance with *good electricity industry practice*. In particular, the *Network Operator* shall ensure that all new *protection apparatus* including that installed on *User's* equipment complies with IEC Standard 60255 and that all new *current transformers* and *voltage transformers* comply with *Australian Standard AS\_60044.1\_(2007)* and *Australian Standard AS\_60044.2\_(2007)*.

#### 2.9.1.4 General requirements

- (a) All *primary equipment* on the *network* shall be protected so that if an equipment fault occurs, the faulted equipment item is automatically removed from service by the operation of circuit breakers or fuses.
- (b) *Protection systems* shall be designed and their settings coordinated so that, if there is a fault, unnecessary equipment damage is avoided and any reduction in *power transfer capability* or in the level of service provided to *Users* is minimised.

- (c) Consistent with the requirement of clause ~~2.9.1.4~~2.9.1.4(b), *protection systems* shall remove faulted equipment from service in a timely manner and ensure that, where practical, those parts of the *network* not directly affected by a fault remain in service.

## 2.9.2 Duplication of protection

~~To implement a “one out of two” arrangement, complete secondary equipment redundancy is required. This includes CT and VT secondaries, auxiliary supplies, cabling and wiring, circuit breaker trip coils and batteries and intertripping arrangements.~~

To implement a “one out of two” arrangement, complete secondary equipment redundancy is required. This includes CT and VT secondaries, auxiliary supplies, cabling and wiring, circuit breaker trip coils and batteries and intertripping arrangements.

### 2.9.2.1 Equipment connected at voltages of 66- kV and above

- (a) *Primary equipment* shall be protected by a main *protection system* that shall remove from service only those items of *primary equipment* directly affected by a fault.
- (b) The main *protection system* shall comprise *two fully independent protection schemes of differing principle*, connected to operate in a “one out of two” arrangement.
- ~~(a)~~ One of the independent *protection schemes* shall include earth fault
- (c) *protection*.
- ~~(b)~~ To maintain the integrity of the two *protection schemes*, no electrical cross
- (d) *connections* shall be made between them.
- ~~(c)~~ It shall be possible to test and maintain either *protection scheme*
- (e) *independently* without affecting the other.
- (f) Where both *protection schemes* require end-to-end communications, independent *teleprotection signalling* equipment and communication channels shall be provided.
- (g) Where failure of the *teleprotection signalling* would result in the failure of both *protection schemes* to meet the requirements of this clause ~~2.9.2.12~~2.9.2.1 independent communication bearers shall be provided.
- (h) *Primary equipment* shall also be protected by a back-up *protection system* in addition to the main *protection system*. The back-up *protection system* shall isolate the faulted *primary equipment* if a circuit breaker fails to operate.
- (i) The design of the main *protection system* shall make it possible to test and maintain either *protection scheme* without interfering with the other.

2.9.2.2 Equipment connected at voltages of less than 66- kV

~~(d)~~—Each item of *primary equipment* shall be protected by two independent  
(a)  protection systems.

~~(e)~~—One of the independent *protection systems* shall be a main *protection system*  
(b)  that shall remove from service only the faulted item of *primary equipment*.

- (c) At least one of the *protection schemes* shall include earth fault *protection* so as to give additional coverage for low level earth faults and to provide some remote backup.
- (d) The other independent *protection system* may be a back-up *protection system*.
- (e) Notwithstanding the requirements of clause ~~2.9.2.2~~(2.9.2.2)(a), where a part of the *distribution system* may potentially form a separate island the *protection system* that provides *protection* against islanding shall comprise *two fully independent protection schemes of differing principle*.
- (f) Where appropriate, and with the approval of the *Network Operator*, a single set of high rupturing capacity (HRC) fuses may be used as a *protection scheme* for *plant* at 33-kV and below, in which case a second *protection scheme* would not be required to satisfy the requirements of this clause ~~2.9.2.2~~ 2.9.2.2.

### 2.9.3 Availability of protection systems

All *protection schemes* on the *network*, including any back-up or *circuit breaker failure protection scheme* and associated intertripping, shall be kept operational at all times except when maintenance is required.

### 2.9.4 Maximum total fault clearance times

- (a) This clause ~~2.9.4~~2.9.4 applies to short circuit faults of any type on *primary equipment* at nominal system *voltage*. Where *critical fault clearance times* exist, these times may be lower and take precedence over the times stated in this clause ~~2.9.4~~2.9.4. *Critical fault clearance time* requirements are set out in clause ~~2.9.5~~2.9.5.
- (b) For *primary equipment* operating at *transmission system voltages* of 132-kV and 66-kV the maximum total fault clearance times in ~~Table 5~~Figure 5 apply to the *nominal voltage* of the circuit breaker that clears a particular fault for both minimum and maximum *system conditions*. For *primary equipment* operating at *distribution system voltages* of 33-kV and below the maximum total fault clearance times specified in ~~Table 6~~Figure 6 may be applied to all circuit breakers required to clear a fault for maximum *system conditions*, irrespective of the *nominal voltage* of the circuit breaker.
- (c) For *primary equipment* operating at 132-kV and 66-kV:
  - (1) Both of the *protection schemes* of the main protection system must operate to achieve a total fault clearance time no greater than the “No CB Fail” time given in ~~Table 5~~Figure 5. The backup protection system must achieve a total fault clearance time no greater than the “CB Fail” time in ~~Table 5~~Figure 5, except that the second protection scheme that protects against small zone faults must achieve a total fault clearance time no greater than 400 msec;
  - (2) For a small zone fault coupled with a circuit breaker failure, maximum total fault clearance times are not defined.

- (3) In ~~Table 5~~~~Figure 5~~~~Figure 5~~, for voltages of 66-kV and above, the term “local” refers to the circuit breaker(s) of a protection system where the fault is located:
- (i) within the same *substation* as the circuit breaker;
  - (ii) for a transmission line between two *substations*, at or within 50% of the line impedance nearest to the *substation* containing the circuit breaker, provided that the line is terminated at that *substation*; or
  - (iii) for a transmission line between more than two *substations*, on the same line section as the *substation* containing the circuit breaker, provided that the line is terminated at that *substation*.
- (4) In ~~Table~~~~Figure~~ 5, for voltages of 66-kV and above, the term “remote” refers to all circuit breakers required to clear a fault, apart from those specified in clause ~~2.9.4~~~~(2.9.4)~~~~(c)~~(3).
- (d) In ~~Table 6~~~~Figure 6~~~~Figure 6~~, for *primary equipment* operating at *nominal voltage* of 33-kV and below, the term “local” refers only to faults located within the *substation* in which a circuit breaker is located.

~~Table 5~~~~Figure 5~~ – 132-kV and 66-kV maximum total fault clearance times (msec)

		No CB Fail	CB Fail
132-kV and 66-kV	Local	150	400
	Remote	200	450

~~Table 6~~~~Figure 6~~ – 33-kV and below maximum total fault clearance times (msec)

		No CB Fail	CB Fail
33-kV and below	Local	1160	1500
	Remote	Not defined	Not defined

## 2.9.5 Critical fault clearance times

~~One of the major factors affecting the transient stability of the network is the fault clearance time. The critical fault clearance time is the longest time that a fault can be allowed to remain on the power system to ensure that transient instability does not occur. Critical fault clearance times are established for the various fault types at key locations. Protection then shall be set to ensure that the critical fault clearance times are achieved.~~

~~One of the major factors affecting the transient stability of the network is the fault clearance time. The critical fault clearance time is the longest time that a fault can be allowed to remain on the power system to ensure that transient instability does not occur. Critical fault clearance times are established for the various fault types at key~~

locations. Protection then shall be set to ensure that the *critical fault clearance times* are achieved.

2.9.5.1 *Critical fault clearance times*

Where a *critical fault clearance time* to preserve system stability has been established by the *Network Operator* in a portion of the *network*:

- (a) For *plant* operating at *voltages* of 66-kV or higher, each of the two independent *protection schemes* shall be capable of detecting and clearing *plant* faults within the *critical fault clearance time*.



- (b) Where a *critical fault clearance time* exists for *plant* operating at 33-kV and below
- ~~(1)~~ one *protection scheme* shall be capable of detecting and clearing *plant*
  - (1) faults within the *critical fault clearance time*; and
  - (2) the second *protection scheme* is required to meet the maximum acceptable *fault clearance times* set out in clause ~~(e)~~ (c).
- (c) Other *critical fault clearance time* requirements may be imposed by the *Network Operator* to limit system *voltage* and/or *frequency* disturbances resulting from faults.

### 2.9.6 Protection sensitivity

- (a) Protection schemes must be sufficiently sensitive to detect fault currents in the *primary equipment* taken into account the errors in protection apparatus and *primary equipment* parameters under the system conditions in this clause ~~2.9.6-2.9.6~~.
- (b) For minimum and maximum system conditions, all protection schemes must detect and discriminate all *primary equipment* faults within their intended normal operating zones.
- (c) For abnormal equipment conditions involving two *primary equipment* outages, all *primary equipment* faults must be detected by one protection scheme and cleared by a protection system. Backup protection systems may be relied on for this purpose. Fault clearance times are not defined under these conditions.

### 2.9.7 Trip supply supervision

Where loss of power supply to its secondary circuits would result in protection scheme performance being reduced, all protection scheme secondary circuits must have trip supply supervision.

### 2.9.8 Trip circuit supervision

All protection scheme secondary circuits that include a circuit breaker trip coil must have trip circuit supervision, which monitor the health of the trip coil under both circuit breaker opened and closed positions.

### 2.9.9 Protection flagging, indication, fault and event records

All protective devices supplied to satisfy the protection requirements must contain such indicating, flagging, fault and event recording as is sufficient to enable the determination, after the fact, of which devices caused a particular trip.

Any failure of the tripping supplies, protection apparatus and circuit breaker trip oils must be alarmed and operating procedures must be put in place to ensure that prompt action is taken to remedy such failures.

## 2.10 Variation of service quality parameters

- (a) In particular circumstances, the requirements in clause ~~2-02~~ of this Code may be varied.
- ~~(e)~~ The *Network Operator* may vary the Code in accordance with the *derogation*
- (b) provisions of clause ~~12-012~~.
- (c) Where it is intended to vary the requirements set out in this Code, it shall be demonstrated that the variation will not adversely affect *Users* or *power system security*.

## 3 Technical requirements for equipment connected to the network

### 3.1 Introduction

#### ~~1.2~~ Introduction

- (a) The objective of this clause ~~3-03~~ is to facilitate maintenance of the *power system* service quality parameters specified in clause ~~2-02~~, so that other *Users* are not adversely affected and that personnel and equipment safety are not put at risk.
- (b) This clause sets out details of the technical requirements which *Users* shall satisfy as a condition of *connection* of any equipment to the *network* including, but not limited, to the following types of equipment:
  - (1) ~~Generation Units~~ *Generating units* connected at all *voltage* levels of the *network*;
  - (2) Small ~~Generation Units~~ *generating systems* connected at *voltages* of 22-~~kV~~ and below;
  - (3) *Small Inverter Energy Systems* connected to the *low voltage network*; and
  - (4) *Loads*, including those with electronic switching systems, *connected* at all *voltage levels of the network.*  
~~*voltage levels of the network.*~~
- (c) The *Network Operator* shall determine the classification of equipment to be connected to the *network* and may alter the technical requirements of connection in this clause ~~3-03~~ in respect of a particular *connection* only as much as is necessary to ensure the *power system* service quality parameters specified in clause ~~2-02~~ are maintained.
- (d) An exemption may be granted by the *Network Operator* to certain provisions in clause ~~3-03~~ in accordance with the *derogations* in clause ~~1-7-012~~ of the *Code*.

#### 3.1.3.2 Requirements for ~~all network~~ *Network Users* excluding *Generator Users* under clause 3.3

The requirements under this clause apply to all *Network Users* except *Generator Users* captured under clause 3.3, unless expressly referred to in a subclause within clause 3.3.

#### 3.1.13.2.1 Network performance standards

A *User* shall ensure that each of its *facilities* connected to the *network* is capable of operation while the *power system* is operating within the parameters of the performance standards set out in clause ~~1-7-2-1.7.2~~.

3.2.1.1 Voltage fluctuations

**3.1.21.1.1 Voltage fluctuations**

A *User* shall maintain its contributions to flicker at the *connection point* to below the limits allocated by the *Network Operator* under clause 2.4.1.2.4.1.

3.1.2.13.2.1.2 -Harmonic voltage distortion

- ~~(a)~~ A *User* shall comply with any harmonic emission limits allocated by the
- (a) *Network Operator* in accordance with clause 2.4.2.2.4.2 of the *Code*.
  - (b) A *User* shall ensure that the injection of harmonics or interharmonics from its equipment or *facilities* into the *network* does not cause the maximum system harmonic *voltage* levels at the point of *connection* to exceed the levels set out in clause ~~17.2~~ 017.2 of the *Network Planning Criteria*.

### 3.1.2.23.2.1.3 Direct current injection

A *User* shall ensure that any DC component of current produced by its own equipment complies with the requirements of clause ~~4.7.2.2~~17.2.2 of the *Network Planning Criteria*.

### 3.2.1.4 Voltage unbalance

## ~~3.1.31.1.1~~ Voltage unbalance

A *User connected* to all three phases shall balance the current drawn in each phase at its *connection point* so as to achieve levels of negative sequence *voltage* at all *connection points* that are equal to or less than the values specified in clause ~~2.4.3~~2.4.3.

### ~~3.1.3.13.2.1.5~~ Stability

- (a) *Users* shall cooperate with the *Network Operator* to achieve stable operation of the *networks* and shall install emergency controls as reasonably required by the *Network Operator*.
- (b) The cost of installation, maintenance and operation of the emergency controls shall be borne by the *User*.
- (c) The stability criteria stated in clause ~~2.6~~2.6 shall be satisfied under the worst credible system *load* and ~~Generation~~generation pattern, and the most severe *credible contingency event* arising from either a single *credible contingency event* at up to 100% *peak load* or a double *credible contingency event* at up to 80% *peak load*.
- (d) *Credible contingency events* shall be considered in accordance with clause ~~2.7~~2.7.

### ~~3.2.1.2~~ Electromagnetic interference

### 3.2.1.6 Electromagnetic interference

A *User* shall ensure that the electromagnetic interference caused by its equipment does not exceed the limits set out in clause ~~2.5~~2.5.

### ~~3.1.3.23.2.1.7~~ Fault levels

- (a) A *User connected* to the *network* may not install or *connect* equipment at the *connection point* that is rated for a *maximum fault current* lower than that specified in the ~~Access Agreement~~connection agreement in accordance with clause ~~3.6.6~~3.6.6.
- (b) A *User connected* to the *network* shall not install equipment at the *connection point* that is rated for a *maximum fault current* lower than that specified in clause ~~15.4~~15.4 of the *Network Planning Criteria* unless a lower *maximum fault current* is agreed with the *Network Operator* and specified in the ~~Access Agreement~~connection agreement.
- (c) Where a *User's* equipment increases the fault levels in the *transmission system*, responsibility for the cost of any upgrades to the equipment required as a result of

the *changed power system* conditions will be dealt with by commercial arrangements between the *Network Operator* and the *Users*.

~~3.1.3.33.2.1.8~~ 3.1.3.33.2.1.8 Main switch

~~Except as provided in clause 3.3.2.11, a)~~ *User* shall be able to de-energise its own equipment without reliance on the *Network Operator*.

~~3.1.3.43.2.1.9~~ 3.1.3.43.2.1.9 *Users' power quality monitoring equipment*

- (a) The *Network Operator* may require a *User* to provide accommodation and connections for the *Network Operator's* power quality monitoring and recording equipment within the *User's facilities* or at the *connection point*. In such an event the *User* shall meet the requirements of the *Network Operator* in respect of the installation of the equipment and shall provide access for reading, operating and maintaining this equipment.
- (b) The key inputs that the *Network Operator* may require a *User* to provide to the *Network Operator's* power quality monitoring and recording equipment include:
  - (1) three phase *voltage* and three phase current and, where applicable, neutral *voltage* and current; and
  - (2) digital inputs for circuit breaker status and *protection* operate alarms hardwired directly from the appropriate devices. If direct hardwiring is not possible and if the *Network Operator* agrees, then the *User* may provide inputs measurable to 1 millisecond resolution and GPS synchronised.

~~3.1.3.53.2.1.10~~ 3.1.3.53.2.1.10 *Power system simulation studies*

- (a) A *User* shall provide to the *Network Operator* such of the following information relating to any of the *User's facilities connected* or intended to be *connected* to the *transmission system* as is required to enable the undertaking of *power system simulation studies*:
  - (1) a set of functional block diagrams, including all transfer functions between feedback signals and ~~Generation Unit~~ *generating unit* output;
  - (2) the parameters of each functional block, including all settings, gains, *time constraints*, delays, dead bands and limits; and
  - (3) the characteristics of non-linear elements.
- (b) The *Network Operator* may provide any information it so receives to any *User* who intends to *connect* any equipment to the *transmission system* for the purposes of enabling that *User* to undertake any *power system simulation studies* it wishes to undertake, subject to that *User* entering into a confidentiality agreement with the *Network Operator*, to apply for the benefit of the *Network Operator* and any *User* whose information is so provided, in such form as the *Network Operator* may require.

#### 3.1.3.63.2.1.11 Technical matters to be coordinated

- (a) The *User* and the *Network Operator* shall use all reasonable endeavours to agree upon the following matters in respect of each new or altered *connection*:
- (1) design at *connection point*;
  - (2) physical layout adjacent to *connection point*;
  - (3) *protection* and backup;
  - (4) control characteristics;
  - (5) communications, metered quantities and alarms;
  - (6) insulation co-ordination and lightning *protection*;
  - (7) fault levels and fault clearing times;
  - (8) switching and isolation *facilities*;
  - (9) interlocking arrangements;
  - (10) *metering* installations as described in [clause 10; the Chapter 7A of the NT NER](#);
  - (11) *synchronising facilities*;
  - (12) *under frequency load shedding* and islanding schemes;
  - (13) out of step/pole slip *facility*; and
  - (14) any special test requirements.
- (b) Prior to *connection* to the *Network Operator's* power system, the *Users* shall have provided to the *Network Operator* a signed statement to certify that the equipment to be *connected* has been designed and installed in accordance with this *Code*, all relevant standards, all statutory requirements and *good electricity industry practice*.

#### 3.1.43.2.2 Provision of information

- (a) A *User* shall provide all data reasonably required by the *Network Operator*.
- (b) Details of the kinds of data that may be required are included in [clause 11-11](#) and Attachment 3 of this *Code*.

#### 3.1.53.2.3 Protection requirements

*Protection* shall be provided to detect and clear faults, without system instability and without causing equipment damage, in accordance with [clauses 2.6 and 2.9](#) [clauses 2.6 and 02.9](#).

##### 3.1.5.13.2.3.1 Transmission lines and other Plant operated at 66- kV and above

- (a) *Protection* shall be by two fully independent *protection schemes* as set out in [clause 2.9.2.1-2.9.2.1](#).



(b) The *protection* arrangements shall be capable of clearing a fault within the clearance times set out in clause [2.9.5-2.9.5](#).

~~3.1.5.23.2.3.2~~ Interconnectors and ties operated at 33-kV and below

- (a) *Protection* shall be by two fully independent *protection schemes* as set out in clause ~~2.9.2.2.2.9.2.2.~~
- (b) The *protection* arrangements shall be capable of clearing a fault within the clearance times set out in clause ~~2.9.5.2.9.5.~~

~~3.1.5.33.2.3.3~~ Feeders, reactors, capacitors and other plant operated at 33-kV and below

- (a) The *protection* arrangements shall be capable of clearing a fault within the clearance times set out in clause ~~2.9.5.2.9.5.~~
- (b) Where a *critical fault clearance time* exists, *protection* of these items will be by two independent *protection schemes* of *differing principle*, each one discriminating with the *Network Operator power system* and capable of meeting the *critical fault clearance time*.
- (c) At least one of these *protection schemes* shall also include earth fault *protection* so as to give additional coverage for low level earth faults and to provide some remote backup.
- (d) Where there is no *critical fault clearance time*, the following shall be the minimum *protection* requirement:
  - (1) three Phase Inverse Definite Minimum *Time* Overcurrent; and
  - (2) three Phase Instantaneous Overcurrent; and
  - (3) inverse Definite Minimum *Time* Earth Fault; and
  - (4) instantaneous Earth Fault.
- (e) With the approval of the *Network Operator*, a single set of HRC fuses may be deemed to provide equivalent *protection* to subclause (c) of this ~~clause 3.2.3.3-clause 3.2.3.3.~~

~~3.1.5.43.2.3.4~~ Transformers

~~The composition of each of the two *protection schemes* should be complementary such that, in combination, they provide dependable clearance of transformer faults within a specified *time*. With any single failure to operate of the *secondary plant*, fault clearance shall still be achieved by *transformer protection*, but may be delayed until the nature of the fault *changes or evolves*.~~

~~*Protection of transformers larger than 3 MVA will require at least one of the protection schemes to be a unit protection and provide high-speed fault clearance of transformer faults.*~~

The composition of each of the two protection schemes should be complementary such that, in combination, they provide dependable clearance of transformer faults within a specified time. With any single failure to operate of the secondary plant, fault clearance shall still be achieved by transformer protection, but may be delayed until the nature of the fault changes or evolves.

Protection of transformers larger than 3 MVA will require at least one of the protection schemes to be a unit protection and provide high-speed fault clearance of transformer faults.

- (a) For transformers with a primary voltage of 66 kV and above, protection shall be by two fully independent protection schemes as set out in ~~clause 2.9.2.1-clause 2.9.2.1.~~

- (b) For *transformers* with a primary *voltage* of 33-kV and below, *protection* shall be by two *protection schemes* which are *complementary*, as set out in clause ~~2.9.2.2~~ 2.9.2.2.
- (c) The *protection* arrangements shall be capable of clearing a fault within the clearance times set out in clause ~~2.9.5.2.9.5~~ 2.9.5.2.9.5.

#### ~~3.1.5.53.2.3.5~~ 3.1.5.53.2.3.5 Protection discrimination

~~Where the *Network Operator protection* is overcurrent, the maximum operate time will be 1 second at maximum fault level. Generally, *Network Operator* overcurrent and earth fault *protection* employs devices with standard inverse characteristics to BS142 with a 3 second curve at 10 times current and time multiplier of 1.0. Note that this is the specification of the characteristic rather than the device setting. Operating times for other types of *protection* will generally be lower and will be dependent upon location.~~

~~The *protection* in clauses 3.2.3.1, 3.2.3.2, 3.2.3.3-Where the *Network Operator protection* is overcurrent, the maximum operate time will be 1 second at maximum fault level. Generally, *Network Operator* overcurrent and 3.2.3.4-earth fault *protection* employs devices with standard inverse characteristics to BS142 with a 3 second curve at 10 times current and time multiplier of 1.0. Note that this is the specification of the characteristic rather than the device setting. Operating times for other types of *protection* will generally be lower and will be dependent upon location.~~

The *protection* in clauses 3.2.3.1, 3.2.3.2, 3.2.3.3 and 3.2.3.4 is required to discriminate with the *Network Operator's protection* on the power system.

#### ~~3.1.5.63.2.3.6~~ 3.1.5.63.2.3.6 Backup protection

- (a) The *protection* in clauses ~~3.2.3.1, 3.2.3.2, 3.2.3.3-3.2.3.1, 3.2.3.2, 3.2.3.3~~ and ~~3.2.3.4-3.2.3.4~~ is required to be backed up by an independent *protection* to ensure clearance of faults with a *protection* failure.
- (b) *Backup protection* shall be provided to detect and clear faults involving small zones.
- (c) *Protection* shall be provided to detect and clear faults involving *circuit breaker failure*.
- (d) Where *critical fault clearance times* do not exist, or are greater than the times given in clause ~~2.9.5.2.9.5~~ 2.9.5.2.9.5, the clearance times are to be as specified by the *Network Operator* in ~~an *Access Agreement*~~ a *connection agreement*.
- (e) Such *protection schemes* shall be capable of detecting and initiating clearance of uncleared or *small zone faults* under both normal and *minimum system conditions*.
- (f) Under abnormal *plant* conditions, all primary system faults shall be detected and cleared by at least one *protection scheme* on the *User's* equipment. *Remote backup protection* or standby *protection* may be used for this purpose.

3.1.5.73.2.3.7 Protection alarm requirements

- (a) Specific requirements and the interface point to which alarms shall be provided will be mutually decided during the detailed design phase. These alarms will be brought back to the *Network Operator's control centre* via the installed SCADA system supplied by the *User* in accordance with clause ~~3.2.5 or clause 3.3.3, 3.2.5 of clause 1.1.1~~, as applicable.

- (b) In addition, any failure of the *User's* tripping supplies, *protection apparatus* and circuit breaker trip coils shall be alarmed within the *User's* installation and operating procedures put in place to ensure that prompt action is taken to remedy such failures.

#### 3.1.5.83.2.3.8 Islanding of a User's facilities from the power system

- (a) Unless otherwise agreed by the *Network Operator*, a *User* shall ensure that islanding of its ~~Generation~~*generation* plant together with part of the *Network Operator* power system, cannot occur upon loss of supply from the *Network Operator's* power system.
- (b) Clause ~~3.2.3.8~~(3.2.3.8)(a) should not preclude a design that allows a *User* to island its own ~~Generation~~*generation* and plant load, thereby maintaining supply to that plant, upon loss of supply from the *Network Operator's* power system.
- (c) Islanding shall only occur in situations where *Power and Water's* power system is unlikely to recover from a major disturbance.
- (d) Unless otherwise agreed by the *Network Operator*, the *User* shall provide facilities to initiate islanding in the event of their system drawing more than the agreed MW/MVAR demands from the *Network Operator* power system for a specified time.
- (e) *Users* shall co-operate to agree with the *Network Operator* the type of initiating signal and settings to ensure compatibility with other *protection* settings on the network and to ensure compliance with the requirements of clause ~~2.2.2.2~~2.2.2.2.
- (f) Where a *User* does not wish to meet the requirements of clause ~~2.2.2.2~~2.2.2.2, appropriate commercial arrangements will be required between the *User*, the *Network Operator* and/or another *User(s)* to account for the higher level of access service.

#### 3.1.5.93.2.3.9 Automatic reclose equipment

The installation and use of *automatic reclose equipment* in a *User's* facility and in the *power system* shall only be permitted with the prior written agreement of *Network Operator*.

#### 3.1.5.103.2.3.10 Maintenance of protection

- (a) *Users* shall regularly maintain their *protection systems* at intervals of not more than 3 years. Records shall be kept of such maintenance and the *Network Operator* may review these. Refer also to clause ~~5.205.2~~5.205.2.
- (b) Each scheduled routine test, or any unscheduled tests that become necessary, shall include both a calibration check and an actual trip operation of the associated circuit breaker.

- (c) All maintenance and testing of *User* owned *protection* shall be carried out by personnel suitably qualified and experienced in the commissioning, testing and maintenance of *primary plant* and *secondary plant* and equipment.

#### **3.1.63.2.4 Design requirements for Users' substations**

The following requirements apply to the design, station layout and choice of equipment for a *substation*.

- (a) Safety provisions shall comply with requirements applicable and notified by the *Network Operator*.
- (b) Where required by the *Network Operator* appropriate interfaces and accommodation shall be incorporated by the *Users* for *metering*, communication *facilities*, remote monitoring and *protection* of *plant* that is to be installed in the *substation* by the *Network Operator*.
- (c) A *substation* shall be capable of *continuous uninterrupted operation* with the levels of *voltage*, harmonics, unbalance and *voltage* fluctuation from all sources as defined in clause 2 of this *Code*.
- (d) Earthing of *primary plant* in the *substation* shall be in accordance with the Electricity Supply Association of Australia Substation Earthing Guide, and shall reduce step and touch potentials to safe levels.
- (e) *Synchronisation facilities* or reclose blocking shall be provided if *Generating Units/generating units* are connected through the *substation*.
- (f) Secure electricity supplies of adequate capacity to provide for the operation for at least eight hours of *plant* performing *metering*, communication, monitoring, and *protection* functions, on loss of AC supplies, shall be provided.
- (g) *Plant* shall be tested to ensure that the *substation* complies with the design and specifications required by clause ~~3.2.3.10~~ 3.2.3.10. Where appropriate, type test certificates provided by the manufacturer satisfy this clause.
- (h) The *protection* equipment required would normally include *protection schemes* for individual items of *plant*, back-up arrangements, auxiliary DC supplies and instrumentation *transformers*.
- (i) Insulation levels of *plant* in the *substation* shall co-ordinate with the insulation levels of the *network* to which the *substation* is connected without degrading the design performance of the *network*.
- (j) Prior to *connection* to the *Network Operator's* power system, the *User* shall have provided to the *Network Operator* a signed written statement to certify that the equipment to be connected has been designed and installed in accordance with:
  - (1) this *Code*;
  - (2) all relevant standards;
  - (3) all statutory requirements; and

- (4) *good electricity industry practice.*

The statement shall have been certified by a Chartered Professional Engineer with NPER-3 standing with the Institution of Engineers, Australia, unless otherwise agreed.

### **3.1.73.2.5 Remote monitoring and control requirements**

- (a) The *Network Operator* may require the *User* to:
- (1) provide *remote monitoring equipment (RME)* to enable the *Network Operator* to remotely monitor status and indications of the *load facilities* where this is reasonably necessary in real *time* for control, planning or security of the *power system*; and
  - (2) upgrade, modify or replace any *RME* already installed in a *power station* provided that the existing *RME* is, in the reasonable opinion of the *Network Operator*, no longer fit for purpose and notice is given in writing to the relevant *User*.
- (b) The *RME* provided, upgraded, modified or replaced (as applicable) under subclause (a) shall conform to an acceptable standard as agreed by the *Network Operator* and shall be compatible with the *Network Operator's SCADA system*, including the requirements of clause [4.9.4.9](#) of this *Code*.
- (c) Input information to *RME* may include, but not be limited to, the following:
- (1) Status Indications
    - (i) relevant circuit breakers open/closed (double pole) within the *plant*  
~~*plant*~~
    - (ii) relevant isolators within the *plant*
    - (iii) *connection* to the *network*
  - (2) Alarms
    - (i) *protection fail*
    - (ii) battery fail - AC and DC
    - (iii) *Trip circuit supervision*
    - (iv) *Trip supply supervision*
  - (3) Measured Values
    - (i) *active power load*
    - (ii) *reactive power load*
    - (iii) *load current*
    - (iv) relevant *voltages* throughout the *plant*
  - (4) Sequence-of-event (SOE) points
    - (i) *protection operation*



- (ii) circuit breaker status
- (5) Such other input information reasonably required by the *Network Operator*.

### **3.1.83.2.6 Communications equipment**

- (a) A *User* shall provide electricity supplies for any *RME* installed in relation to its *plant* capable of keeping these *facilities* available for at least eight hours following total loss of *supply* at the *connection point* for the relevant *plant*.
- (b) A *User* shall provide communications paths (with appropriate redundancy) between any *RME* installed at its *plant* to a communications interface at the relevant *plant* and in a location reasonably acceptable to the *Network Operator*.
  - ~~(a) Communications systems between this communications interface and the relevant control centre shall be the responsibility of the *Network Operator* unless otherwise agreed.~~
  - ~~(c) Communications systems between this communications interface and the relevant control centre shall be the responsibility of the *Network Operator* unless otherwise agreed.~~
  - ~~(e)(d)~~ The cost of the communications systems shall be met by the *User*, unless otherwise determined by the *Network Operator*.

### **3.1.93.2.7 Secure electricity supplies**

Secure electricity supplies of adequate capacity to provide for the operation for at least eight hours of *plant* performing *metering*, communication, monitoring, and *protection* functions, on loss of AC supplies, shall be provided by a *User*.

### **3.1.103.2.8 Load shedding facilities**

If reasonably required by the *Network Operator*, *Users* are to provide automatic ~~interruptible load to the *Network Operator* in accordance with clause 2.2.2.~~  
~~interruptible load to the *Network Operator* in accordance with clause 2.2.2.~~

#### **3.1.103.2.8.1 Load to be available for disconnection**

- (a) It is a requirement for *power system security* that 75% of the *power system load* at any *time* be available for *disconnection*:
  - (1) under the automatic control of *under frequency* relays; and
  - (2) under manual or automatic control from *control centres*; and/or
  - (3) under the automatic control of *under voltage* relays.
- (b) In some circumstances, it may be necessary to have up to 90% of the *power system load*, or up to 90% of the *load* within a specific part of the *network*, available for automatic *disconnection*. The *Network Operator* will advise *Users* if this additional requirement is necessary.

- (c) Special *load shedding* arrangements may be required to be installed to cater for abnormal operating conditions.

- (d) Subject to clauses ~~4.3.4~~(4.3.4)(c) and ~~4.3.4~~(4.3.4)(d), arrangements for *load shedding* shall be agreed between the *Network Operator* and *User* and can include the opening of circuits in a *network*.
- (e) The *Network Operator* shall specify, in the ~~Access Agreement~~*connection agreement*, control and monitoring requirements to be provided by a *User* for *load shedding facilities*.

#### ~~3.1.10.23~~ 2.8.2 Installation and testing of load shedding facilities

*Users* shall, if reasonably required by the *Network Operator*:

- (a) Provide, install, operate and maintain *facilities for load shedding* in respect of any *connection point*.
- (b) Co-operate with the *Network Operator* in conducting periodic functional testing of the *facilities*, which shall not require *load* to be *disconnected*, provided *facilities* are available to test the scheme without shedding *load*.
- (c) Apply *under frequency* settings to relays as determined by the *Power System Controller*.
- (d) Apply *under voltage* settings to relays as determined by the *Network Operator*.

#### ~~3.1.11~~ 2.9 Impact on power system performance

- (a) Prior to a *User's facilities* being *connected* to the *power system*, the impact on *power system* performance due to the *Users' facilities* is to be determined by *power system* simulation studies as specified by the *Network Operator*.
- (b) These studies may be performed by the *User* or a third party, in which case, the *Network Operator* will require full details of the studies performed including, without limitation:
  - (1) assumptions made;
  - (2) results;
  - (3) conclusions; and
  - (4) recommendations.
- (c) The acceptance of studies performed by a *User* or a third party will be entirely at the *Network Operator's* discretion.
- (d) Acceptance of *power system* studies by the *Network Operator* does not absolve *Users* of responsibility/liability for damages or losses incurred by others.
- ~~(a)~~ The *Network Operator* reserves the right to perform its own studies (at the *User's* cost) and will provide details of such studies to the *User*.
- (e) ~~User's~~ *User's* cost) and will provide details of such studies to the *User*.
- (f) The *Network Operator* will make the final determination on the suitability of a *User's facilities* and the requirements to be fulfilled prior to and after the *facilities* are *connected*, in accordance with this *Code*.

### **3.1.123.2.10** Safety criteria

- (a) As part of the planning process the safety risk should be considered for any new developments and existing *facilities* which may have a significant impact on safety. The safety risk is to be assessed in the planning process. Relevant bodies should be informed, consulted and steps taken to ensure safety is maintained to industry standards.
- (b) The ESAA National Electricity Network Safety (NENS) Code shall be applied and reference shall be made to the NENS Reference Guidelines.

### **3.1.133.2.11** Environmental criteria

- (a) Environmental management of the *transmission* and *distribution networks* will be in keeping with the ESAA Code of Environmental practice. This applies in planning, construction, operation and *decommissioning*.
- (b) *Users* shall inform and consult with relevant public bodies, community interest groups and the general public, and shall avoid where economically possible the use of land where conflicting uses or potential conflicting uses exist.

### **3.1.143.2.12** Construction criteria

#### **3.1.14.13.2.12.1** Overhead lines

Overhead lines and cable systems shall be designed and constructed to *Australian Standard* HB C(b)1, "Guidelines for Design and Maintenance of Overhead Distribution and Transmission lines".

#### **3.1.14.23.2.12.2** Underground cables

Cables shall be installed in a manner that takes into account the local environmental and service conditions, the location of other utilities' services and the risk of damage from excavation. Installation practices shall be in accordance with ESAA Code C(b)2, "Guide to the Installation of Cables Underground".

### **3.23.3** Requirements for connection of Generators

- ~~(a) The Network Operator will carry out detailed power system studies to determine performance requirements to be expected from a proposed new Generation Unit or modification to an existing Generation Unit.~~
- ~~(b) All costs associated with these studies, including studies to obtain any necessary optimal settings for the Generation Unit and its controls shall be borne by the User.~~
- ~~(c) The User shall be responsible for all costs associated with the installation, performance verification, parameter tuning and model validation of any additional equipment identified in the studies.~~
- ~~(d) Users will be responsible for ensuring that plant capabilities and ratings are~~

monitored on an ongoing basis to ensure continued suitability as conditions

~~on the power system change in the future (eg. increasing fault levels as additional plant is connected to the power system).~~

- ~~(e) A User will be responsible for the cost of any plant upgrades required at its facilities as a result of changing power system conditions.~~
- ~~(f) If, after installation of a User's facilities, it is found that the installation is adversely affecting the security or reliability of the power system, the quality of supply, or the installation does not comply with the Code or the relevant Access Agreement, the User shall be responsible for remedying the problem at its cost.~~

### 3.3.1—Protection requirements

- ~~(a) Protection of a Generator shall generally be at the discretion of the User, but shall be sufficient to protect the Generator from faults on the Network Operator power system.~~
- ~~(b) Protection of a Generator will be by two fully independent protection schemes of differing principle, each one discriminating with the protection schemes used on the Network Operator power system.~~
- ~~(c) Where a critical fault clearance time exists, each protection shall be capable of meeting the critical fault clearance time.~~
- ~~(d) Generator protection schemes are to meet the fault clearance times specified in clause 2.9.5.~~
- ~~(e) In addition, the User shall provide protection and controls to achieve, even under circuit breaker fail conditions, the following functions:
  - ~~(1) Separation of the User's Generation Plant from the Network Operator power system in the event of any of the above protection schemes operating.~~
  - ~~(2) Separation of the User's Generation Plant from the Network Operator power system in the event of loss of supply to the User's installation from the Network Operator's power system.~~
  - ~~(3) Prevention of the User's Generation Plant from energising de-energised Network Operator plant, or energising and supplying an otherwise isolated portion of the Network Operator's power system.~~
  - ~~(4) Adequate protection of the User's equipment and complete installation without reliance on back up from the Network Operator's protection.~~~~

#### 3.2.1.1—Check synchronising

- ~~(a) Check synchronising interlocks shall include a feature such that circuit breaker closure via the check synchronism interlock is not possible if the permissive closing contact is closed prior to the circuit breaker close signal being generated. Such a feature is intended to protect the check synchronism~~

~~interlock permissive contact from damage and to ensure out-of-synchronism closure cannot occur if the contact is welded closed.~~

~~(b) Distinction should be drawn between check *synchronising* interlocks and *synchronising* facilities (refer to This clause 3.3 has been adapted from the National Electricity Rules v114 Schedule 5.2 for use in the Northern Territory.~~

### 3.3.1 Outline of requirements

~~This clause 3.3.5).~~

- ~~(c) The check *synchronising* interlocks may be installed on circuit breakers within the *Network Operator's power system* where the risk of out-of-synchronism closure is unacceptable. This will be installed by the *Network Operator* at the *User's cost*.~~
- ~~(d) In addition, the check *synchronising* interlocks shall be installed on all *Users'* circuit breakers capable of out-of-synchronism closure, unless otherwise interlocked.~~

#### 3.3.2—Technical characteristics

- ~~(a) If required by the *Network Operator* a *User* shall provide *power system* stabilising facilities on each *synchronous Generation Unit* if *power system* simulations indicate such a requirement.~~
- ~~(b) If required by the *Network Operator*, a *User* shall ensure that new *synchronous Generation Units* have a short circuit ratio of not less than 0.5 if necessary to limit the reduction in *power transfer* capabilities that are determined by transient stability considerations.~~
- ~~(c) A *User* shall ensure that its *Generation Unit(s)* comply with the requirements advised by the *Network Operator* as to the minimum subtransient reactance that the *Generation Unit* may have if necessary to control fault levels on the *network*.~~
- ~~(d) A *User* shall ensure that its *Generation Unit(s)* satisfy the *Network Operator's* reasonable requirements to ensure stability of the *electricity network* and maintain *power transfer* capabilities. These requirements will have an impact on the *Generator*, governor and excitation system parameters, including the inertia constant, of the *Generation Unit*.~~
- ~~(e) The technical requirements described in this clause 3.3.2 are required to be demonstrated by the methods described in clause 5.4 of this Code.~~

##### 3.3.2.1—*Reactive power capability*

- ~~(a) Each *Generation Unit*, and the *power station* in which the *Generation Unit* is located, shall be capable of continuously providing its full *reactive power output* within the full range of steady state voltages at the *connection point* permitted under clause 2 and clause 15.2 of the *Network Planning Criteria*.~~

(b) Unless otherwise agreed by the Network Operator:

(1) Each synchronous *Generation Unit*, while operating at any level of active power output between its registered maximum and minimum active power output level, shall be capable of:

- (i) supplying at its generator machine's terminals an amount of reactive power of at least the amount equal to the product of the rated active power output of the *Generation Unit* at nominal voltage and 0.750; and
- (ii) absorbing at its generator machine's terminals an amount of reactive power of at least the amount equal to the product of the rated active power output of the *Generation Unit* at nominal voltage and 0.484.

This clause requires a *Generation Unit*, when producing its registered maximum active power output, to be capable of operating at any power factor between 0.8 lagging and 0.9 leading.

These 3.3 sets out details are displayed in Figure 1. The minimum reactive power capability requirement is shown shaded.

**Figure 1 – Synchronous *Generation Unit* reactive power capability**

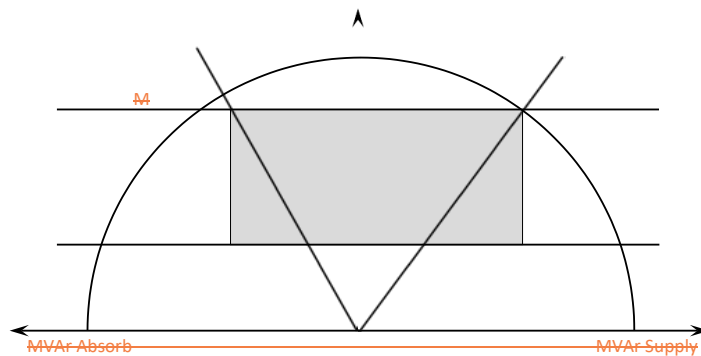

(2) Each induction *Generation Unit*, while operating at any level of active power output between its registered maximum and minimum output level, shall be capable of supplying or absorbing an amount of reactive power at the connection point of at least the amount equal to the product of the rated active power output of the *Generation Unit* at nominal voltage and 0.329.

This clause requires an induction *Generation Unit*, when producing its registered maximum active power output, to be capable of operating at any power factor between 0.95 lagging and 0.95 leading.



These details are displayed in Figure 2. The minimum *reactive power* capability requirement is shown shaded.

**Figure 2—Induction Generation Unit reactive power capability**

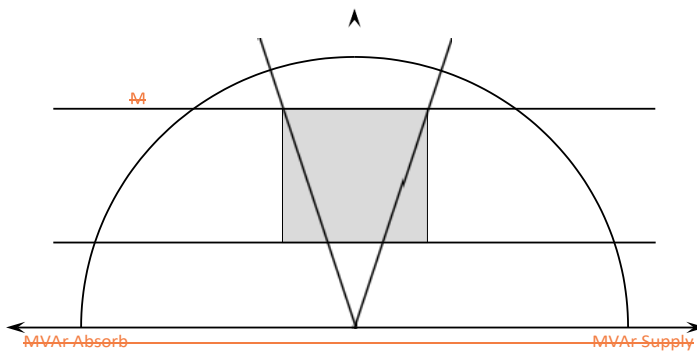

- (3) Where necessary to meet the performance standards specified in clause 2, the *Network Operator* may require an induction *Generation Unit* to be capable of *supplying* or *absorbing* a greater amount of *reactive power* output than specified in clause 3.3.2.1(b)(2). The need for such a requirement will be determined by power system simulation studies and any such a requirement shall be included in the *Access Agreement*.
- (4) Each inverter coupled *Generation Unit* or converter coupled *Generation Unit*, while operating at any level of active power output between its registered maximum and minimum output level, shall be capable of *supplying* reactive power such that at the inverter or converter *connection point* the lagging power factor is less than or equal to 0.95 and shall be capable of absorbing reactive power at a leading power factor less than or equal to 0.95.

These details are displayed in Figure 3. The minimum *reactive power* capability requirement is shown shaded.

**Figure 3 — Inverter-coupled Generation Unit reactive power capability**

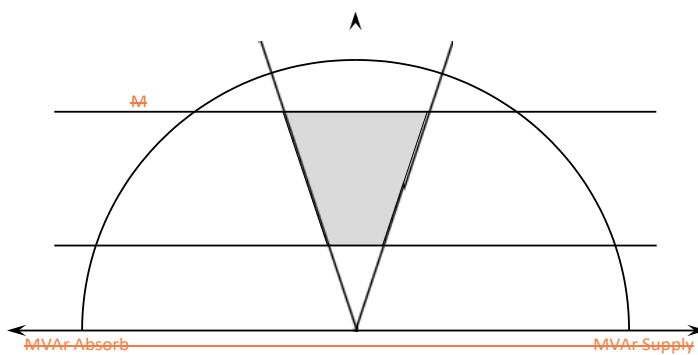

- (5) — Where necessary to meet the requirements of the *Code*, the *Network Operator* may require an inverter *Generation Unit* to be capable of supplying a reactive power output coincident with rated active power output over a larger *power factor* range. The need for such a requirement will be determined by power system simulation studies and any such a requirement shall be included in the *Access Agreement*.
- (c) — For *Generation Units* not described by clause 3.3.2.1(b), the *power factor* requirements shall be as advised by the *Network Operator* and included in the *Access Agreement*. In determining the appropriate *power factor* requirement, the *Network Operator* shall consider the intrinsic capabilities of such a new technology and the potential for its penetration.
- (d) — If the *power factor* capabilities specified in clause 3.3.2.1(b) cannot be provided, the *Generator* shall reach an arrangement under the *Access Agreement* with the *Network Operator* for the supply of the deficit in *reactive power* at the *connection point*. The basis for negotiation will be the responsibility of the proponent to provide an equivalent reactive performance (MVar output) over a range of voltages at the *connection point*.

Clause 3.3.2.1(d) is intended to facilitate flexibility in design by assisting proponents to connect *Generation Units* that, of themselves, are not capable of meeting the *reactive power generation* requirements specified in clause 3.3.2.1(b) through providing for the shortfall to be made up through some other means.

- (e) — Each *Generation Unit's* connection shall be designed to permit the *dispatch* of the full *active power* and *reactive power* capability of the facility as specified in the *Access Agreement* under all power system conditions contained in clause 2.

### 3.3.2.2—Quality of electricity generated

- (a) ~~When operating *unsynchronised*, a *synchronous Generation Unit* shall generate a constant *voltage* level with balanced *phase voltages* and harmonic *voltage* distortion equal to or less than permitted in accordance with either Australian Standard AS/NZS 1359.102.3:2000 “Rotating Electrical Machines—General Requirements” or a recognised equivalent international standard, as agreed between the *Network Operator* and the *User*.~~
- (b) ~~For non-*synchronous* of additional requirements and conditions that *Generators* the contributions to *quality of supply* shall be not less than that required to be provided by *Users* as defined in clause 2.4.~~

### 3.3.2.3—Generation Unit response to disturbances in the power system

The following are design requirements for *Generation Units*. *Network* performance requirements are detailed in clause 2 of this *Code*.

- (a) ~~A *Generation Unit*, and the *power station* in which the *Generation Unit* is located, shall be capable of continuous uninterrupted operation within the *frequency* limits specified in clause 2.2.~~
- (b) ~~Subject to clause 3.3.2.3(b) a *Generation Unit*, and the *power station* in which the *Generation Unit* is located, shall be capable of continuous uninterrupted operation during the occurrence of the range of *voltage* variation conditions permitted by clause 2.3, including the *voltage* dip caused by a *network* fault which causes *voltage* at the *connection point* to drop to zero for up to 500 milliseconds in any one phase or combination of phases, followed by a period of ten seconds where *voltage* may vary in the range 80-110% of the nominal *voltage*, and a subsequent period of three minutes in which the *voltage* may vary within the range 90-110% of the nominal *voltage*.~~
- (c) ~~The *Network Operator* may agree to vary the requirements of clause 3.3.2.3(b) provided that it is satisfied that the *Network* performance standards of clause 2 of the *Code* and the *system* stability requirements of clause 16 of the *Network Planning Criteria* would be met.~~

### 3.3.2.4—Partial load rejection

- (a) ~~A *Generation Unit* shall be capable of continuous uninterrupted operation, during and following a *load* reduction which occurs in less than 0.5 seconds, from a fully or partially *loaded* must satisfy as a *condition* provided that the *load* reduction is less than 50% of the *Generation Unit*'s *nameplate rating* and the *load* remains above minimum *load* or as otherwise agreed between the *Network Operator* and the relevant *User* and stated in the *Access Agreement* between them of *connection* of a *generating system* to the *power system*.~~

### 3.3.2.5—Loading rates

~~A *scheduled Generation Unit* shall be capable of increasing or decreasing *load* in response to a manually or remotely initiated *loading* order at a rate not less than~~

~~5% of nameplate rating per minute or as otherwise agreed between the Network Operator and the relevant User, stated in their Access Agreement.~~

~~3.3.2.6 — Safe shutdown without external electricity supply~~

~~A Generation Unit shall be capable of being safely shut down without electricity (b) supply available from the network at the relevant This clause 3.3 applies to Generators with a generating system that:~~

- ~~i. meets any materiality threshold established in a Northern Territory regulatory instrument for this purpose; or~~
- ~~ii. is connected or intended for use in a manner the Network Operator considers is likely to cause a material degradation in the quality of supply to other Network Users; or~~
- ~~iii. in the absence a materiality threshold referred to in subparagraph (i) above, has a rating of 2 MW or more.~~

~~Note: Generators that undertake the process under Chapter 5A or clause 5.3A of the NT NER may be assessed by the Network Operator in full or in part against the criteria under clause 3.3.5 of this Code.~~

- ~~(c) This clause 3.3 also sets out the requirements and conditions which, subject to clause 3.3.5, are obligations on Generators:~~

~~to co-operate with the relevant Network Operator on technical matters when making a new connection point.~~

~~3.3.2.7 — Restart following restoration of external electricity supply~~

- ~~(1) If reasonably required by the Network Operator, a Generation Unit shall be capable of being restarted, and synchronised to the power system without unreasonable delay following restoration of external supply from the network power system at the relevant connection point, after being without external supply for two hours or less, provided that the Generation Unit was disconnected for any reason other than a fault within the Generation Unit.~~

~~(a) Examples of unreasonable delay in the restart of a Generation Unit are:~~

- ~~(1) — delays not inherent in the design of the relevant start up facilities and which could reasonably have been eliminated by the relevant User; and~~
- ~~(2) — the start up facilities for a new Generation Unit not being designed to minimise start up time delays for the Generation Unit following loss of external supplies for two hours or less.~~

~~3.3.2.8 — Protection of Generation Units from power system disturbances~~

~~(a) A Generation Unit shall be automatically disconnected from the power system in response to conditions at the relevant connection point that are not within the agreed engineering limits for operating the Generation Unit or where the conditions may impact on other Users. If reasonably required by the Network Operator, these abnormal conditions will include and are not necessarily limited to:~~

- ~~(1) — loss of synchronism (out of step protection/pole slip protection may~~

need to be located on the network; this should be determined by performing power system simulation studies);

- (2) ~~sustained high or low frequency outside the power system frequency range 47 Hz to 52 Hz (in the case of operation below 47 Hz but at or above 45 Hz, all Generators shall remain connected to the Network Operator's network for a period of at least two seconds—refer to clause 2.2.2);~~
- (3) ~~sustained excessive Generation Unit stator current that cannot be automatically controlled;~~
- (4) ~~excessive high or low stator voltage;~~
- (5) ~~excessive voltage to frequency ratio;~~
- (6) ~~excessive negative phase sequence current;~~
- (7) ~~loss of excitation; and~~
- (8) ~~reverse power.~~

- (b) ~~The actual settings of the protection equipment installed on a Generation Unit determined by the User to satisfy requirement (a) of this clause shall be consistent with power system performance requirements specified in clause 2 and shall be approved by the Network Operator in respect of their potential to reduce power system security. They shall be such as to maximise plant availability, to assist the control of the power system under emergency conditions and to minimise the risk of inadvertent disconnection consistent with the requirements of plant safety and durability.~~
- (c) ~~The Network Operator shall bear no responsibility for any loss or damage incurred by the User as a result of a fault on either the power system, the User's facility or within the Generation Unit itself.~~

~~3.3.2.9 — Users' protection systems that impact on power system security~~

~~Refer to clause 3.2.3 for the requirements of protection systems for Users' plant. The requirements of clause 3.2.3 apply only to protection that is necessary to maintain power system security. Protection solely for User risks is at the User's discretion.~~

~~3.3.2.10 — Generator transformer tapping~~

~~Unless otherwise agreed between the Network Operator and the User, the Generator transformer of a Generation Unit shall be capable of off-load tap-changing within the range specified in the relevant Access Agreement.~~

~~3.3.2.11 — Tripping of Generation Units and associated loads~~

~~Unless otherwise agreed by the Network Operator, the tripping of a User's Generation Unit which is connected to the network will require the intertripping of associated loads within 0.2 seconds unless the loads are the subject of an Access Agreement with the Network Operator and the User has contracted for the provision of standby power and that standby power is available at the time of the tripping of the Generation Unit.~~

~~3.3.3 — Monitoring and control requirements~~

~~3.3.3.1 — Remote monitoring~~

~~The Network Operator will require the Users to:~~

- (a) ~~Provide remote monitoring equipment ("RME") to enable the Network Operator and the Power System Controller to remotely monitor performance of a Generation Unit (including its dynamic performance) where this is reasonably necessary in real time for control, planning or security of the power system; and~~
- (b) ~~Upgrade, modify or replace any RME already installed in a power station provided that the existing RME is, in the reasonable opinion of the Network Operator, no longer fit for purpose and notice is given in writing to the relevant Users.~~

~~(c) In clause 3.3.3.1(a) and 3.3.3.1 (b), the RME provided, upgraded, modified or replaced (as applicable) shall conform to an acceptable standard as agreed by the Network Operator and shall be compatible with the Network Operator's SCADA system, including the requirements of clause 4.9 of this Code.~~

~~(1) Input information to RME may include, but not be limited to, the following:~~

~~(1) Status Indications~~

~~(i) Generation Unit circuit breaker open/closed (double pole)~~

~~(ii) remote Generation load control on/off~~

~~(iii) Generation Unit operating mode~~

~~(iv) governor limiting operation~~

~~connection to the network~~

~~(2) Alarms~~

~~(i) Generation Unit circuit breaker tripped by protection~~

~~(ii) prepare to off load~~

~~(i) Protection Defective Alarms~~

~~(3) Measured Values~~

~~(i) Gross active power output of each Generation Unit~~

~~a. Net station active power import or export at each connection point~~

~~(ii) Gross reactive power output of each Generation Unit~~

~~b.a. Net station reactive power import or export at each connection point~~

~~(iii) Generation Unit stator voltage~~

~~(iv) Generation Unit transformer tap position~~

~~(2) to provide information to the Network Operator or Power System Controller.~~

~~(d) The equipment associated with each generating system must be designed to withstand without damage the range of operating conditions which may arise consistent with the system standards.~~

~~(e) Generators must comply with the performance standards and any attached terms or conditions of agreement agreed with the Network Operator or Power System Controller in accordance with a relevant provision of clauses 2.2 to 2.6 inclusive.~~

~~(v) This clause 3.3.3.2 Net station output of active energy~~

~~(impulse) (viii) Generation Unit remote Generation control high~~

~~limit value~~

~~(ix) Generation Unit remote Generation control low limit value~~

~~Generation Unit remote Generation control rate limit value~~

~~(4) Such other input information reasonably required by the Network Operator.~~

### ~~3.3.3.2 Remote control~~



- (a) ~~A User may install remote control equipment (“RCE”) that is adequate to enable the Power System Controller to remotely control:~~
- ~~(1) the active power output of any Generation Unit; and~~
  - ~~(2) the reactive power output of any Generation Unit;~~
- ~~in a system emergency.~~

~~(f)~~ Where a User does not provide RCE, the User shall satisfy the Network Operator and set out arrangements by which a Generator may enter into an agreement or contract with the Power System Controller to:

~~(1) provide additional services that adequate arrangements are necessary to maintain power system security; or~~

~~(2) provide additional services to facilitate management of the market.~~

~~(b)(g)~~ This clause 3.3 provides for automatic access standards and the determination of negotiated access standards which once determined, must be recorded together with the automatic access standards in place to allow connection agreement and registered with the Power System Controller to give directions to the User for the control of the Users' Generation Units in a system emergency, and to allow the User to respond appropriately to those directions. These arrangements shall include the control of active power and reactive power as performance standards.

~~(b)~~ Unless agreed otherwise, the relevant User will be responsible for the following actions at the request of the Network Operator:

~~(1) activating and de-activating RCE installed in relation to any Generation Unit; and~~

~~(2) setting the minimum and maximum levels to which, and a maximum rate at which, the Power System Controller will be able to adjust the performance of any Generation Unit using RCE.~~

### 3.3.3.3 Communications equipment

~~(a)~~ A User shall provide electricity supplies for the RME and RCE installed in relation to its Generation Units capable of keeping these facilities available for at least eight hours following total loss of supply at the connection point for the relevant Generation Unit.

~~(b)~~ A User shall provide communications paths (with appropriate redundancy) between the RME or RCE installed at any of its Generation Units to a communications interface at the relevant power station and in a location reasonably acceptable to the Network Operator.

~~(c)~~ Communications systems between this communications interface and the relevant control centre shall be the responsibility of the Network Operator unless otherwise agreed.

~~(1) The User shall meet the cost of the communications systems, unless otherwise determined by the Network Operator.~~

~~(2)(1)~~ Telecommunications between the Power System Controller and Generators shall be established in accordance with the requirements set down below for operational communications.

~~(i) Primary Speech Facility~~

~~(i) Each User shall provide and maintain equipment by means of which~~

~~routine and emergency control telephone calls may be established between the User's responsible Engineer/Operator and the Power System Controller.~~  
~~(A) The facilities to be provided, including the interface requirement between the Power System Controller's equipment and the User's equipment shall be specified by the Network Operator.~~

~~(ii)(i) Back-up Speech Facility~~

~~(A) Where the Network Operator advises a User that a back-up speech facility to the primary facility is required, the Network Operator will provide and maintain a separate telephone link or radio installation. The costs of the equipment shall be recovered through the charge for connection.~~

~~(B)(A) The Network Operator shall be responsible for radio system planning and for obtaining radio licenses for equipment used in relation to the Network Operator networks.~~

~~3.3.3.4 Governor system~~

- ~~(a) All Generation Units shall have an automatic governing system capable of droop governing. These governor systems shall include facilities for both speed and load control.~~
- ~~(b) The droop setting of the governor shall be adjustable and capable of operating in the range 1% to 6% droop.~~
- ~~(c) The Power System Controller will determine the governor mode of a Generation Unit in the system.~~
- ~~(d) Unless otherwise agreed between the Network Operator and the relevant User and stated in the Access Agreement between them, Generation Units shall normally operate in 'droop' mode.~~
- ~~(e) If in the Access Agreement, the Network Operator and the relevant User agree to operate the Generation Unit in 'block load' mode (constant active power output of the Generation Unit) or 'import/export' mode (constant active power delivery into the system at the connection point), the Generation Unit shall automatically change to regulating mode if the Generation Unit is islanded from the system.~~
- ~~(f) The User shall notify the Power System Controller prior to a Generation Unit being operated in a mode where the Generation Unit will be unable to respond as specified in the Access Agreement.~~
- ~~(g) The steady state deadband of a Generation Unit (sum of increase and decrease in power system frequency before a measurable change in the Generation Unit's active power output occurs) shall be less than 0.05 Hz.~~
- ~~(h) For a load increase of 20% of the Generation Unit's nameplate rating, the Generation Unit shall re-enter the steady state deadband within 3 seconds of the load change, provided that the load on the Generation Unit after the load increase does not exceed the Generation Unit's nameplate rating.~~
- ~~(i) The governor system of a Generation Unit shall be adjusted for stable performance under all operating conditions.~~
- ~~(j) The structure and parameter settings of all components of the governor control equipment, including the speed/load controller, actuators (for~~

### **3.3.2 ~~example hydraulic valve positioning systems), valve flow characteristics, limiters, valve operating sequences and steam tables for steam turbine (as appropriate) shall be provided to the Application of settings~~**

- (a) A Generator must only apply settings to a control system or a protection system that are necessary to comply with performance requirements of this clause 3.3 if the settings have been approved in writing by the relevant Network Operator and, if the requirement is one that would involve the Power System Controller (being a negotiated access standard), also by the Power System Controller. A Generator must not allow its generating unit to supply electricity to the power system without such prior approval.
- (b) If a Generator seeks approval from the Network Operator to apply or change a setting, then (except in the case of settings to be applied or changed by the Generator in connection with an emergency frequency control scheme) approval must not be withheld unless the Network Operator or, if the requirement is one that would involve the Power System Controller (being a negotiated access standard), the Power System Controller, reasonably determines that the changed setting would cause the generating unit to not comply with the relevant performance standard or cause an intra-regional power transfer capability to be reduced.
- (c) If the Network Operator or, if the requirement is one that would involve the Power System Controller (being a negotiated access standard), the Power System Controller, reasonably determines that a setting of a generating unit's control system or protection system needs to change to comply with the relevant performance standard or to maintain or restore an intra-regional power transfer capability, the Network Operator or involve the Power System Controller (as applicable) must consult with the relevant Generator, and the Network Operator may request in writing that a setting be applied in accordance with the determination.
- (d) The Network Operator may also request a test to verify the performance of the relevant plant with the new setting. The Network Operator must provide the Power System Controller with a copy of its request to a Generator to apply a setting or to conduct a test.
- (e) A Generator who receives such a request must arrange for the notified setting to be applied as requested and for a test to be conducted as requested. After the test, the Generator must, on request, provide both the Power System Controller and the Network Operator with a report of a requested test, including evidence of its success or failure. Such a report of a test is confidential information.
- (f) A Generator must not change a setting requested by the Network Operator without its prior written agreement. If the Network Operator requires a Generator to change a setting within 18 months of a previous request, the Network Operator

must pay the *Generator* its reasonable costs of changing the setting and conducting the tests as requested.

### **3.3.3 Technical matters to be co-ordinated**

- (a) A *Generator* and the relevant *Network Operator* in sufficient detail to enable the dynamics of these components to be characterised for short and long term simulation studies, must use all reasonable endeavours to agree upon relevant technical matters in respect of each new or altered connection of a *generating system* to a *network* including:
- (1) design at the *connection point*;
  - (2) physical layout adjacent to the *connection point*;
  - (3) primary protection and *backup protection*;
  - (4) control characteristics;
  - (5) communications *facilities*;
  - (6) insulation co-ordination and lightning protection (paragraph (b));
  - (7) fault levels and fault clearance;
  - (8) switching and isolation *facilities*;
  - (9) interlocking and *synchronising* arrangements; and
  - (10) metering installations as described in Chapter 7A of the *NT NER*.
- (b) A *Generator* must ensure that in designing a *generating system's* electrical plant, including any substation for the connection of the *generating system* to the *network*, to operate at the same *nominal voltage* as at the *connection point*:
- (1) the *plant* complies with the relevant Australian Standards unless a provision of this *Code* allows or requires otherwise;
  - (2) the earthing of the *plant* complies with the ENA EG1-2006: Substation Earthing Guide to reduce step and touch potentials to safe levels;
  - (3) the *plant* is capable of withstanding, without damage the *voltage* impulse levels specified in the *connection agreement*;
  - (4) the insulation levels of the *plant* are co-ordinated with the insulation levels of the *network* to which the *generating system* is connected as specified in the *connection agreement*; and
  - (5) safety provisions in respect of the *plant* comply with requirements applicable to the participating jurisdiction in which the *generating system* is located, as notified by the *Network Operator*.
- (c) If no relevant Australian Standard exists for the purposes of paragraph (b)(1), the *Generator* must agree with the *Network Operator* for the *Generator* to comply with another relevant standard.
- (d) Prior to *connection* to the *Network Operator's* power system, the *Users* shall have provided to the *Network Operator* a signed statement to certify that the

equipment to be connected has been designed and installed in accordance with this Code, all relevant standards, all statutory requirements and good electricity industry practice.

### **3.3.4 Provision of information**

#### **Data to be provided by Generators**

(a) A Generator shall provide the data specified in clause 11.2.

(b) The Generator shall provide all other data reasonably required by the Network Operator. This shall include a control block diagram data shall include, without limitation, full Electromagnetic Transient (EMT) and Root Mean Square (RMS) models (and all model parameters) of:

(1) the generating units;

(2) the excitation control systems;

(3) turbine / engine governor systems; in suitable form to perform

(4) power system stabilisers; and

(5) inverter control systems;

to enable the Network Operator to conduct dynamic simulations and,

(c) These models shall be in a form which is compatible with the power system analysis software used by the Network Operator (currently PSS/E from Siemens PTI). The proposed settings for the governor system for all expected modes of governor operation shall also be provided, and PowerFactory) and shall be inherently stable. These models shall be provided in both encrypted and unencrypted form (in circumstances required by the Generator Modelling Guidelines) and be supported by a separate releasable user guide for both the RMS and EMT models.

(d) These parameters shall not be varied without prior approval. Details of the kinds of data that may be required are included in Attachment 3 of this Code, specifically:

(1) Schedule S3.1 - Generating unit design data;

(2) Schedule S3.2 - Generating unit setting data;

(3) Schedule S3.5 - Network and plant technical data; and

(4) Schedule S3.6 - Network plant and apparatus setting data.

~~(b)~~(e) Data provided by a *Generator* under this clause 3.3.4 may be shared by the *Network Operator* with other *Generators*, for the purposes of this *Code*, subject to the restrictions set out in the remainder of clause 3.3.4.

The overriding objective of a *Generation Unit's* voltage control system is to maintain the specified voltage range at the *connection point*.

Each *Generator* must therefore provide sufficient *reactive power* injection into, or absorption from, the *transmission system* or *distribution system* to meet the *reactive power* requirements of its loads, plus all *reactive power* losses required to deliver its real power output at system voltages within the ranges specified in the relevant *Access Agreement* for normal operation and contingency conditions.

#### ~~3.3.3.5~~ — *Excitation control system*

The *excitation control system* of a *synchronous Generation Unit* shall be capable of:

~~(a)~~ limiting *Generation Unit* operation at all load levels to within *Generation Unit*

(f) The *Network Operator* **must** develop and publish *Generator Modelling Guidelines* and *Generator Modelling Change Management Requirements* for the purposes of this *Code*. The *Network Operator* **must consult with the Utilities Commission and with Users** before issuing or amending the guidelines or requirements.

#### **Network modelling information for connection applicants**

(g) A *connection applicant* for a new or modified *generating unit* or *generating system* seeking *connection* to the network, ~~may request from the *Network Operator*:~~

- (1) information that is reasonably required by the *connection applicant* to carry out power system simulation studies (including load flow and dynamic simulations) for planning and operational purposes; and
- (2) operation and maintenance procedures and practices for network operation, sufficient to enable the *connection applicant* to carry out power system modelling under normal, outage and emergency conditions.

(h) If the *Network Operator* holds information requested under paragraph (g), the *Network Operator* must provide the requested information to the *connection applicant* as soon as practicable, subject to the following requirements:

- (1) If the *Network Operator* holds and is required under this paragraph (h) to provide a *releasable user guide* that the *Network Operator* received from a *Generator*, the *Network Operator* must provide the *releasable user guide* to the *connection applicant* in an unaltered form.
- (2) If the *Network Operator* holds and is required under this paragraph (h) to provide a form of the model source code that the *Network Operator* received from a *Generator* or from any other source, the *Network Operator* must provide that information:



- (i) only in the form of, at the *Network Operator's* discretion:
  - (A) encrypted information; or
  - (B) a secured format agreed by the provider of the model source code,  
unless the *Network Operator* has the written consent of the person who  
provided the information to the *Network Operator* to provide it in  
another form; and
- (ii) — in a form that can be interpreted by a software simulation product  
nominated by the *Network Operator*.

#### **Confidentiality and use of information**

- (i) Any information provided by the *Network Operator* under paragraph (h) to a  
connection applicant must be treated as confidential information.
- (j) A connection applicant who receives information under paragraph (h) may only  
use that information for the purpose of designing its *generating unit* or *generating*  
system and connection to the network, may only disclose such information to its  
employees and its external engineering advisers for use for such purpose and must  
not otherwise disclose or use the information
- (k) A connection applicant who receives information under paragraph (h) must ensure  
any employees and engineering advisers to whom it discloses the information keep  
it confidential and only use it for the purpose referred to in paragraph (j).

### **3.3.5 Technical requirements**

The following technical requirements describe the *automatic access standards* for new  
or modification of existing, *generating units* or *generating systems* seeking connection  
to the network. A connection applicant may propose an alternative *negotiated access*  
standard by applying the following:

- (a) A negotiated access standard must:
  - (1) be set at a level that will not adversely affect power system security;
  - (2) be set at a level that will not adversely affect the quality of supply for other  
Network Users.
- (b) When submitting a proposal for a negotiated access standard, a connection  
applicant must propose a standard that is as close as practicable to the  
corresponding automatic access standard, having regard to:
  - (1) the need to protect the plant from damage;
  - (2) power system conditions at the location of the proposed connection;  
and
  - (3) the commercial and technical feasibility of complying with the automatic access  
standard with respect to the relevant technical requirement.

(c) When proposing a *negotiated access standard* under paragraph (b), the *connection applicant* must provide reasons and evidence to the *Network Operator* and *Power System Controller* as to why, in the reasonable opinion of the *connection applicant*, the proposed *negotiated access standard* is appropriate, including:

(1) how the *connection applicant* has taken into account the matters outlined in subparagraphs (b)(1), (b)(2) and (b)(3); and

(2) how the proposed *negotiated access standard* meets the requirements of paragraph (a).

(d) Within 30 business days following the later of:

(1) receipt of a proposed *negotiated access standard*; and

(2) receipt of all information required to be provided by the *connection applicant*,

the *Network Operator* must accept or reject a proposed *negotiated access standard*.

(e) The *Network Operator* must reject the proposed *negotiated access standard* where in the *Network Operator's* reasonable opinion, one or more of the requirements at subparagraphs (a)(1) and (a)(2) are not met.

(f) If the *Network Operator* rejects a proposed *negotiated access standard*, the *Network Operator* must, at the same time:

(1) subject to obligations in respect of *confidential information*, provide to the *connection applicant*:

(i) where the basis for the *Network Operator's* rejection is lack of evidence from the *connection applicant*, details of the additional evidence of the type referred to in paragraph (c) the *Network Operator* requires to continue assessing the proposed *negotiated access standard*;

(ii) detailed reasons in writing for the rejection, including the extent to which each of the matters identified at subparagraphs (a)(1) and (a)(2) contributed to the *Network Operator's* decision to reject the proposed *negotiated access standard*; and

(2) advise the *connection applicant* of a *negotiated access standard* that the *Network Operator* considers meets the requirements of subparagraphs (a)(1), and (a)(2).

(g) The *connection applicant* may in relation to a proposed *negotiated access standard* advised by the *Network Operator* in accordance with subparagraph (f)(2):

(1) accept the proposed *negotiated access standard*;

(2) reject the proposed *negotiated access standard*;

(3) propose an alternative *negotiated access standard* to be further evaluated in accordance with the criteria in paragraph (b); or

(4) elect to adopt the relevant *automatic access standard* or a corresponding *plant standard*.

(h) An automatic access standard or if the procedures in this clause 3.3.5 have been followed a negotiated access standard, that forms part of the terms and conditions of a connection agreement, is taken to be the performance standard applicable to the connected plant for the relevant technical requirement.

#### 3.3.5.1 Reactive Power Capability

(a) The automatic access standard is a generating system operating at:

(1) any level of active power output not exceeding the rated active power; and

(2) any voltage at the connection point within the limits established under clause 15.2(a) without a contingency event.

must be capable of supplying and absorbing continuously at its connection point an amount of reactive power of at least the amount equal to the product of the rated active power of the generating system and 0.395.

(b) A performance standard must record the agreed value for rated active power and where relevant the method of determining the value.

(c) A performance standard for consumption of energy by a generating system when not supplying or absorbing reactive power under an ancillary services agreement is to be established under clause 3.6 as if the Generator were a load.

(d) If the generating system is not capable of the level of performance established under clause 3.3.5.1(a) the Generator, depending on what is reasonable in the circumstances, may request a negotiated access standard in accordance with clause 3.3.5(a) to (h), based on solutions including (without limitation):

(1) reaching a commercial arrangement with the Network Operator for the provision of the deficit of reactive power (supply and absorption) from within the network;

(2) installing additional equipment connecting at the generating system's connection point or another location, to provide the deficit of reactive power (supply and absorption), and such equipment is deemed to be part of the generating system;

(3) reaching a commercial arrangement with a User to provide the deficit of reactive power (supply and absorption); or

(4) if the inability to meet the performance level only occurs for particular operating conditions, agreeing to and documenting as part of the proposed negotiated access standard, operational arrangements by which the plant can achieve an agreed level of performance for those operating conditions.

(e) The Generator may select one or more options referred to in paragraph (d).

### 3.3.5.2 Quality of Electricity Generated

- (a) For the purpose of this clause 3.3.5.2 in respect of a *synchronous generating unit*, AS 1359.101 and IEC 60034-1 are *plant standards* for harmonic *voltage* distortion.
- (b) The *automatic access standard* is a *generating system* when generating and when not generating must not produce at any of its *connection points* for *generation*:
- (1) *voltage* fluctuation greater than the limits allocated by the *Network Operator* under clause 2.4.1;
  - (2) harmonic *voltage* distortion greater than the emission limits specified by a *plant standard* under paragraph (a) or allocated by the *Network Operator* under clause 2.4.2; and
  - (3) *voltage* unbalance greater than the limits allocated by the *Network Operator* in accordance with clause 2.4.3.

### 3.3.5.3 Generating Unit Response to Frequency Disturbance

- (a) For the purposes of this clause 3.3.5.3:
- normal operating frequency band and abnormal operating frequency excursion band** are references to the widest range specified for those terms for any condition (including an “island” condition) in the *frequency operating standards* that apply to the *region* in which the *generating unit* is located.
- stabilisation time** means the longest times allowable for the *frequency* of the *power system* to remain outside the normal operating frequency band, for any condition (including an “island” condition) in the *frequency operating standards* that apply to the *region* in which the *generating unit* is located. The stabilisation time is 10 minutes.
- transient frequency limit and transient frequency time** mean the values of 45 Hz and 2 seconds respectively, or such other values determined by the *Power System Controller*.
- (b) The *automatic access standard* is a *generating system* and each of its *generating units* must be capable of *continuous uninterrupted operation* for *frequencies* in the following ranges:
- (1) the lower bound of the transient *frequency limit* for at least 2 seconds;
  - (2) the lower bound of the limits of the abnormal operating frequency excursion band specified in 2.2.2(b) to the lower bound of the *normal operating frequency band* for at least the stabilisation time;
  - (3) the *normal operating frequency band* for an indefinite period;
  - (4) the upper bound of the *normal operating frequency band* to the upper bound of the abnormal operating frequency excursion band for at least the stabilisation time.

unless the *rate of change of frequency* is outside the range of –4 Hz to 4 Hz per second.

The *automatic access standard* is illustrated in the following diagram reflecting the *frequency standards* outlined in clauses 2.2.1 and 2.2.2.

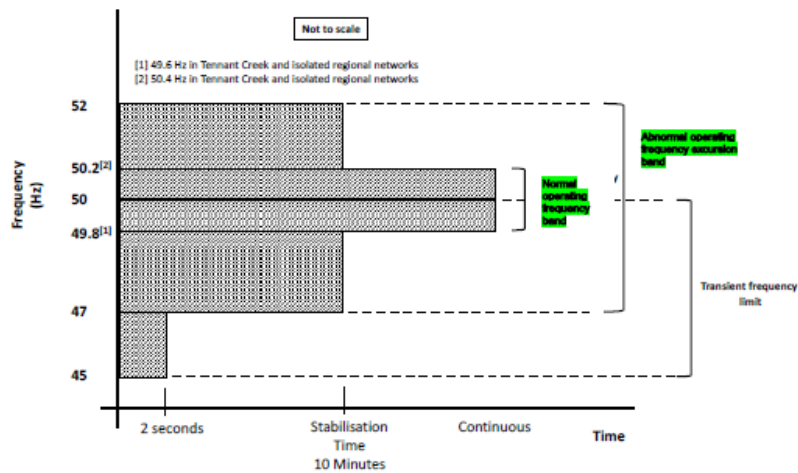

#### 3.3.5.4 Generating System Response to Voltage Disturbances

(a) The automatic access standard is a generating system and each of its generating units must be capable of continuous uninterrupted operation where a power system disturbance causes the voltage at the connection point to vary within the following ranges:

- (1) over 130% of normal voltage for a period of at least 0.02 seconds after T(ov);
- (2) 125% to 130% of normal voltage for a period of at least 0.2 seconds after T(ov);
- (3) 120% to 125% of normal voltage for a period of at least 2.0 seconds after T(ov);
- (4) 115% to 120% of normal voltage for a period of at least 20.0 seconds after T(ov);
- (5) 110% to 115% of normal voltage for a period of at least 20 minutes after T(ov);
- (6) 90% to 110% of normal voltage continuously;
- (7) 80% to 90% of normal voltage for a period of at least 10 seconds after T(uv);  
and
- (8) 70% to 80% of normal voltage for a period of at least 2 seconds after T(uv).

where T(ov) means a point in time when the voltage at the connection point first varied above 110% of normal voltage before returning to between 90% and 110% of normal voltage, and T(uv) means a point in time when the voltage at the connection point first varied below 90% of normal voltage before returning to between 90% and 110% of normal voltage.

(b) The access standard must include any operational arrangements necessary to ensure the generating system and each of its generating units will meet its agreed performance levels under abnormal network or generating system conditions.

### 3.3.5.5 Generating System Response to Disturbances Following Contingency Events

- (a) In this clause 3.3.5.5 a fault includes a fault of the relevant type having a metallic conducting path.
- (b) The *automatic access standard* is:
- (1) for a *generating system* and each of its *generating units*, the requirements of paragraphs (c) and (d);
  - (2) for a *generating system* comprised solely of *synchronous generating units*, the requirements of paragraph (e);
  - (3) for a *generating system* comprised solely of *asynchronous generating units*, the requirements of paragraphs (f) to (i); and
  - (4) for a *generating system* comprised of *synchronous generating units* and *asynchronous generating units*:
    - (i) for that part of the *generating system* comprised of *synchronous generating units*, the requirements of paragraph (e); and
    - (ii) for that part of the *generating system* comprised of *asynchronous generating units*, the requirements of paragraphs (f) to (i).

#### All generating systems

- (c) A *generating system* and each of its *generating units* must remain in *continuous uninterrupted operation* for any disturbance caused by:
- (1) a *credible contingency event*;
  - (2) a three phase fault in a *transmission system* cleared by all relevant primary protection systems;
  - (3) a two phase to ground, phase to phase or phase to ground fault in a *transmission system* cleared in:
    - (i) the longest time expected to be taken for a relevant *breaker fail protection system* to clear the fault; or
    - (ii) if a *protection system* referred to in subparagraph (i) is not installed, the greater of the time specified in clause 2.9.4 Figure 5 (or if none is specified, 450 milliseconds) and the longest time expected to be taken for all relevant *primary protection systems* to clear the fault; or
  - (4) a three phase, two phase to ground, phase to phase or phase to ground fault in a *distribution network* cleared in:
    - (i) the longest time expected to be taken for the *breaker fail protection system* to clear the fault; or
    - (ii) if a *protection system* referred to in subparagraph (i) is not installed, the greater of 1500 milliseconds and the longest time expected to be taken for all relevant *primary protection systems* to clear the fault,

provided that the event is not one that would disconnect the *generating unit* from the *power system* by removing *network* elements from service.

(d) A *generating system* and each of its *generating units* must remain in *continuous uninterrupted operation* for a series of disturbances within any five minute period caused by any combination of the events described in paragraph (c), without limitation on the time difference between successive disturbances unless any of the following conditions are exceeded first:

- (1) ~~there are~~ more than six of the disturbances that cause the *voltage* at the *connection point* to drop below 50% of *normal voltage*;
  - (2) in parts of the network where three-phase automatic reclosure is permitted, more than two of the disturbances are three phase faults, and otherwise, more than one three phase fault where *voltage* at the *connection point* drops below 50% of *normal voltage*;
  - (3) more than one disturbance is cleared by a *breaker fail protection system* or similar back-up *protection system*;
  - (4) there are more than 15 disturbances;  
~~the cumulative time that *voltage* at the *connection point* is lower than 80% of *normal voltage* exceeds 10,000 milliseconds~~  
~~the cumulative time that *voltage* at the *connection point* is lower than 90% of *normal voltage* exceeds 60,000 milliseconds~~
- provided that none of the events would result in:
- (5) the islanding of the *generating system* or cause a material reduction in power transfer capability by removing network elements from service.

#### **Synchronous generating systems**

(e) Subject to any changed *power system* conditions or *energy* source availability beyond the *Generator's* reasonable control, a *generating system* comprised of *synchronous generating units*, in respect of the types of fault described in subparagraphs (c)(2) to (4), must supply to or absorb from the *network*:

- (1) to assist the maintenance of *power system voltages* during the fault, capacitive reactive current of at least the greater of its pre-disturbance reactive current and 4% of the maximum continuous current of the *generating system* including all operating *synchronous generating units* (in the absence of a disturbance) for each 1% reduction (from the level existing just prior to the fault) of *connection point voltage* during the fault;
- (2) after clearance of the fault, *reactive power* sufficient to ensure that the *connection point voltage* is within the range for *continuous uninterrupted operation* under clause 3.3.5.4; and
- (3) from 100 milliseconds after clearance of the fault, *active power* of at least 95% of the level existing just prior to the fault.

#### **Asynchronous generating systems**

(f) Subject to any changed *power system* conditions or *energy* source availability beyond the *Generator's* reasonable control, a *generating system* comprised of *asynchronous generating units*, in respect of the types of fault described in

subparagraphs (c)(2) to (4), must have facilities capable of supplying to or absorbing from the network:

(1) to assist the maintenance of power system voltages during the fault:

(i) capacitive reactive current in addition to its pre-disturbance level of at least 4% of the maximum continuous current of the generating system including all operating asynchronous generating units (in the absence of a disturbance) for each 1% reduction of voltage at the connection point below the relevant range in which a reactive current response must commence, as identified in subparagraph (g)(1), with the performance standards to record the required response agreed with the Network Operator and Power System Controller; and

(ii) inductive reactive current in addition to its pre-disturbance level of at least 6% of the maximum continuous current of the generating system including all operating asynchronous generating units (in the absence of a disturbance) for each 1% increase of voltage at the connection point above the relevant range in which a reactive current response must commence, as identified in subparagraph (g)(1), with the performance standards to record the required response agreed with the Network Operator and Power System Controller,

during the disturbance and maintained until connection point voltage recovers to between 90% and 110% of normal voltage, or such other range agreed with the Network Operator and Power System Controller, except for voltages below the relevant threshold identified in paragraph (h); and

(2) from 100 milliseconds after clearance of the fault, active power of at least 95% of the level existing just prior to the fault.

(g) For the purpose of paragraph (f):

(1) the generating system must commence a response when the voltage is in an under-voltage range of 85% to 90% or an over-voltage range of 110% to 115% of normal voltage. These ranges may be varied with the agreement of the Network Operator and Power System Controller (provided the magnitude of the range between the upper and lower bounds remains at  $\Delta 5\%$ ); and

(2) the reactive current response must have a rise time of no greater than 40 milliseconds and a settling time of no greater than 70 milliseconds and must be adequately damped.

(h) Despite paragraph (f), a generating system is not required to provide a capacitive reactive current response in accordance with subparagraph (f)(1)(i) where:

(1) the generating system is directly connected to the power system with no step-up or connection transformer; and

(2) voltage at the connection point is 5% or lower of normal voltage.

(i) Subject to paragraph (h), despite the amount of reactive current injected or absorbed during voltage disturbances, and subject to thermal limitations and energy source availability, a generating system must make available at all times:



(1) sufficient current to maintain rated apparent power of the *generating system* including all operating *generating units* (in the absence of a disturbance), for all *connection point* voltages above 115% (or otherwise, above the over-voltage range agreed in accordance with subparagraph (g)(1)); and

(2) the maximum continuous current of the *generating system* including all operating *generating units* (in the absence of a disturbance) for all *connection point* voltages below 85% (or otherwise, below the under-voltage range agreed in accordance with subparagraph (g)(1)).

except that the *Network Operator* and *Power System Controller* may agree limits on active current injection where required to maintain *power system security* and/or the *quality of supply* to other *Network Users*.

#### **General requirement**

##### **s—All generating systems**

(i) The performance standard must include any operational arrangements to ensure the *generating system* including all operating *generating units* will meet its agreed performance levels under abnormal network or *generating system* conditions.

(k) When assessing multiple disturbances, a fault that is re-established following operation of automatic reclose equipment shall be counted as a separate disturbance.

(l) The performance standard must specify the cumulative time thresholds for which the *generating system* can remain in continuous operation for a sequence of disturbances consistent with 3.3.5.5(c) and (d). The standard must record the cumulative time with voltage at the *connection point* lower than 80% of *normal voltage* and the cumulative time with voltage at the *connection point* lower than 90% of *normal voltage*.

##### **Asynchronous generating systems**

(m) For the purpose of paragraph (f):

(1) the reactive current contribution may be limited to the maximum continuous current of a *generating system*, including its operating asynchronous *generating units*;

(2) the reactive current contribution and *voltage* deviation described may be measured at a location other than the *connection point* (including within the relevant *generating system*) where agreed with the *Network Operator* and *Power System Controller*, in which case the level of injection and absorption will be assessed at that agreed location;

(3) the reactive current contribution required may be calculated using phase to phase, phase to ground or sequence components of *voltages*. The ratio of the negative sequence to positive sequence components of the reactive current contribution must be agreed with the *Network Operator* and *Power System Controller* for the types of disturbances listed in this clause 3.3.5.5; and

(4) the performance standards must record all conditions (which may include temperature) considered relevant by the Network Operator and Power System Controller under which the reactive current response is required.

#### **Synchronous generating systems and units**

(n) For a generating system comprised solely of synchronous generating units, the reactive current contribution may be limited to 250% of the maximum continuous current of the generating system.

(o) For a synchronous generating unit within a generating system (other than a generating system described in paragraph (m)), the reactive current contribution may be limited to 250% of the maximum continuous current of that synchronous generating unit.

#### **3.3.5.6 Quality of Electricity Generated and Continuous Uninterrupted Operation**

The automatic access standard is a generating system including each of its operating generating units and reactive plant, must not disconnect from the power system as a result of voltage fluctuation, harmonic voltage distortion and voltage unbalance conditions at the connection point within the levels specified in clauses 2.4.1, 2.4.2 and 2.4.3.

#### **3.3.5.7 Partial Load Rejection**

The automatic access standard is a generating system shall be capable of continuous uninterrupted operation, during and following a load reduction which occurs in less than 0.5 seconds, from a fully or partially loaded condition provided that the load reduction is less than 50% of the generating system's nameplate rating and the load remains above minimum load or as otherwise agreed between the Network Operator and the relevant User and stated in the connection agreement between them.

#### **3.3.5.8 Protection of Generating Units from Power System Disturbances**

(a) The automatic access standard is:

(1) Subject to paragraph (d), for a generating system or any of its generating units that is required by a Generator or Network Operator to be automatically disconnected from the power system in response to abnormal conditions arising from the power system, the relevant protection system or control system must not disconnect the generating system for:

(i) conditions for which it must remain in continuous uninterrupted operation; or

(ii) conditions it must withstand under this Code.

(2) A generating system, connected to a network must have facilities to automatically and rapidly reduce its generation:

(i) by at least half, if the frequency at the connection point exceeds a level nominated by the Network Operator (not less than the upper limit of the operational frequency tolerance band) and the duration

above this frequency exceeds a value nominated by the Network Operator where the reduction may be achieved:

(A) by reducing the output of the generating system within 3 seconds, and holding the output at the reduced level until the frequency returns to within the normal operating frequency band; or

(B) by disconnecting the generating system from the power system within 1 second; or

(ii) in proportion to the difference between the frequency at the connection point and a level nominated by the Network Operator (not less than the upper limit of the operational frequency tolerance band), such that the generation is reduced by at least half, within 3 seconds of the frequency reaching the upper limit of the operational frequency tolerance band.

(b) The Network Operator or Power System Controller may require that an access standard include a requirement for the generating system to be automatically disconnected by a local or remote control scheme whenever the part of the network to which it is connected has been disconnected, forming an island that supplies a customer.

(c) The access standard must include specification of conditions for which the generating unit or generating system must trip and must not trip.

(d) Notwithstanding clauses 3.3.5.3, 3.3.5.4, 3.3.5.5, 3.3.5.6 and 3.3.5.7, a generating system may be automatically disconnected from the power system under any of the following conditions:

(1) in accordance with an ancillary services agreement between the Generator and the Network Operator or Power System Controller;

(2) where a load that is not part of the generating system has the same connection point as the generating system and the Network Operator and Power System Controller agree that the disconnection would in effect be under-frequency load shedding;

(3) where the generating system is automatically disconnected under paragraph (a), clause 3.3.5.9 or by an emergency frequency control scheme;

(4) where the generating system is automatically disconnected under clause 3.3.5.10; or

(5) in accordance with an agreement between the Generator and the Network Operator (including an agreement in relation to an emergency control scheme under clause 3.2.1.5 to provide a service that is necessary to maintain or restore power system security in the event of a specified contingency event.)

(e) The Network Operator or Power System Controller is not liable for any loss or damage incurred by the Generator or any other person as a consequence of a fault on either the power system, or within the Generator's facility.

### 3.3.5.9 Protection Systems that Impact on Power System Security

- (a) The automatic access standard is:
- (1) primary protection systems must be provided to disconnect from the power system any faulted element in a generating system and in protection zones that include the connection point within the applicable fault clearance time determined under clause 2.9.4 and 2.9.5;
  - (2) each primary protection system must have sufficient redundancy to ensure that a faulted element within its protection zone is disconnected from the power system within the applicable fault clearance time with any single protection element (including any communications facility upon which that protection system depends) out of service; and
  - (3) breaker fail protection systems must be provided to clear faults that are not cleared by the circuit breakers controlled by the primary protection system within the applicable fault clearance time determined under clause 2.9.4 and 2.9.5
- (b) In relation to an automatic access standard under this clause 3.3.5.9, the Generator must provide redundancy in the primary protection systems under paragraph (a)(2) and provide breaker fail protection systems under paragraph (a)(3) if the Network Operator and Power System Controller consider that a lack of these facilities could result in:
- (1) a material adverse impact on power system security or quality of supply to other Network Users; or
  - (2) a reduction in intra-regional power transfer capability,  
through any mechanism including:
  - (3) consequential tripping of, or damage to, other network equipment or facilities of other Network Users, that would have a power system security impact; or
  - (4) instability that would not be detected by other protection systems in the network.
- (c) The Network Operator and the Generator must cooperate in the design and implementation of protection systems to comply with this clause 3.3.5.9, including cooperation on:
- (1) the use of current transformer and voltage transformer secondary circuits (or equivalent) of one party by the protection system of the other;
  - (2) tripping of one party's circuit breakers by a protection system of the other party; and
  - (3) co-ordination of protection system settings to ensure inter-operation.
- (d) The protection system design referred to in paragraphs (a) must:
- (1) be coordinated with other protection systems;
  - (2) avoid consequential disconnection of other Network Users' facilities; and

(3) take into account existing obligations of the Network Operator under connection agreements with other Network Users.

#### 3.3.5.10 Protection to Trip Plant for Unstable Operation

(a) The automatic access standard is a generating system must have:

- (1) for its synchronous generating units, a protection system to disconnect it promptly when a condition that would lead to pole slipping is detected, to prevent pole slipping or other conditions where a generating unit causes active power, reactive power or voltage at the connection point to become unstable as assessed in accordance with the power system stability criteria established under clause 16; and
- (2) for its asynchronous generating units, a protection system to disconnect it promptly for conditions where the active power, reactive power or voltage at the connection point becomes unstable as assessed in accordance with the guidelines for power system stability established under clause 16.

#### 3.3.5.11 Frequency Control

(a) For the purpose of this clause 3.3.5.11:

- (1) **Drop** means, in relation to frequency response mode, the percentage change in power system frequency as measured at the connection point, divided by the percentage change in power transfer of the generating system expressed as a percentage of the maximum operating level of the generating system. Droop must be measured at frequencies that are outside the deadband and within the limits of power transfer.
- (2) **Maximum operating level** means in relation to:
  - (i) a generating unit, the maximum sent out generation consistent with its nameplate rating to which it may be dispatched; and
  - (ii) a generating system, the combined maximum sent out generation to which its in-service generating units may be dispatched.
- (3) **Minimum operating level** means in relation to:
  - (i) a generating unit, its minimum sent out generation for continuous stable operation;
  - (ii) a generating system, the combined minimum sent out generation of its in-service generating units.

(b) The automatic access standard is:

- (1) subject to energy source availability a generating system's power transfer to the power system must not:

- (i) increase in response to a rise in the *frequency* of the *power system* as measured at the *connection point*; or
  - (ii) decrease in response to a fall in the *frequency* of the *power system* as measured at the *connection point*; and
- (2) subject to energy source availability a *generating system* must be capable of operating in *frequency* response mode such that it automatically provides a proportional:
  - (i) decrease in *power transfer* to the *power system* in response to a rise in the *frequency* of the *power system* as measured at the *connection point*; and
  - (ii) increase in *power transfer* to the *power system* in response to a fall in the *frequency* of the *power system* as measured at the *connection point*,  
  
sufficiently rapidly and sustained for a sufficient period for the *Generator* to be in a position to offer measurable amounts of all *ancillary services* for the provision of *power system frequency control*.
- (c) Each control system used to satisfy this clause 3.3.5.11 must be adequately damped.
- (d) The amount of a relevant market *ancillary service* for which the plant may be registered must not exceed the amount that would be consistent with the performance standard registered in respect of this requirement.
- (e) For the purposes of subparagraph (b)(2):
  - (1) the change in *power transfer* to the *power system* must occur with no delay beyond that required for stable operation, or inherent in the *plant* controls, once the *frequency* of the *power system* as measured at the *connection point* leaves a deadband around 50 Hz;
  - (2) a *generating system* must be capable of setting the deadband and droop within the following ranges:
    - (i) the deadband referred to in subparagraph (1) must be set within the range of 0 to  $\pm 1.0$  Hz. Different deadband settings may be applied for a rise or fall in the *frequency* of the *power system* as measured at the *connection point*; and
    - (ii) the droop must be settable within the range of 1% to 6%, or such other settings as agreed with the *Network Operator* and *Power System Controller*;
  - (3) nothing in subparagraph (b)(2) is taken to require a *generating system* to operate below its minimum operating level in response to a rise in the *frequency* of the *power system* as measured at the *connection point*, or above its maximum operating level in response to a fall in the *frequency* of the *power system* as measured at the *connection point*; and

(4) the performance standards must record:

- (i) agreed values for maximum operating level and minimum operating level and where relevant the method of determining the values, and the values for a generating system must take into account its in-service generating units; and
- (ii) for the purpose of subparagraph (b)(2), the market ancillary services, including the performance parameters and requirements that apply to each such market ancillary service.

#### 3.3.5.12 Impact on Network Capability

- (a) The automatic access standard is a generating system must have plant capabilities and control systems that are sufficient so that when connected it does not reduce any intra-regional power transfer capability below the level that would apply if the generating system were not connected.

A negotiated access standard under this clause 3.3.5.12 must detail the plant capabilities, control systems and operational arrangements that will be maintained by the Generator, notwithstanding that change to the power system, but not changes to the generating system, may reduce the efficacy of the plant capabilities, control systems and operational arrangements over time.

#### 3.3.5.13 Voltage and Reactive Power Control

- (a) For the purposes of this clause 3.3.5.13:  
static excitation system means in relation to a synchronous generating unit, an excitation control system that does not use rotating machinery to produce the field current.

(b) The voltage and reactive power control automatic access standard is:

- (1) The excitation control system of a synchronous generating unit shall be capable of:
  - (i) limiting generating unit operation at all load levels to within generating unit capabilities for continuous operation;
  - (ii) controlling the generating unit output to maintain the short-time average generating unit output voltage at highest rated level (which shall be from a maximum of 5% below the nominal output voltage to at least 5% above the nominal output voltage and is usually 10% above the nominal output voltage);
  - (iii) ensuring that plant capabilities and control systems are sufficient such that:
    - A. power system oscillations, for the frequencies of oscillation of the generating unit against any other generating unit, are adequately damped;

- B. operation of the *generating system* does not degrade the damping of any critical mode of oscillation of the *power system*; and
- C. operation of the *generating system* does not cause instability (including hunting of tap-changing transformer control systems) that would adversely impact other *Users*.
- ~~(i) maintaining adequate *Generation Unit* *generating unit* stability under all operating conditions including providing *power system* stabilising action if fitted with a *power system* stabiliser;~~
- ~~(iv)~~ in the case of a rotating *synchronous generator* *generating unit*,
- ~~(v)~~ the five second ceiling excitation *voltage* shall be at least twice the excitation *voltage* required to achieve maximum continuous rating at *nominal voltage*; and
- ~~(vi)~~ providing reactive current compensation settable for boost or droop unless otherwise agreed by the *Network Operator*.
- (2) ~~Excitation~~ The *excitation* control system performance of a *generating unit* shall be capable of:
- ~~(b)~~ New *synchronous Generation Units* *generating units* shall be fitted with fast acting *excitation control systems* ~~utilising modern technology~~; AC exciter, rotating rectifier or static excitation systems shall be provided for any new *Generation Units* *generating units* with



- (i) a rating greater than 10 MW or for new smaller *Generation Units* generating units within a power station totalling in excess of 10 MW. Excitation control systems shall provide voltage regulation to within 0.5% of the selected set point value.
- (ii) New non-synchronous *Generation Units* generating units must be fitted with fast acting voltage and / or reactive power control systems, which must utilise modern technology and be approved by the Network Operator. Control systems must provide regulation to within 0.5% of the selected set point value.
- (iii) Unless agreed by the Network Operator, new synchronous *Generation Units* generating units shall incorporate power system stabiliser circuits that modulate *Generation Unit* generating unit field voltage in response to changes in power output and/or shaft speed and/or any other equivalent input signal approved by the Network Operator. The stabilising circuits shall be responsive and adjustable over a frequency range that shall include frequencies from 0.1 Hz to 2.5 Hz.
- (iv) The Network Operator may require power system stabiliser circuits on synchronous *Generation Units* generating units with ratings less than or equal to 10 MW or smaller synchronous *Generation Units* generating units within a power station with a total active power output capability less than or equal to 10 MW (if power system simulations indicate a need for such a requirement). Before commissioning of any power system stabiliser, the Generator must propose preliminary settings for the power system stabiliser, which must be approved by the Network Operator.
- (v) Power system stabilisers may also be required for non-synchronous *Generation Units* generating units. The performance characteristics of these *Generation Units* generating units with respect to power system stability must be similar to those required for synchronous *Generation Units* generating units. The requirement for a power system stabiliser and its structure and settings will be determined by the Network Operator from power system simulations.
- (vi) Before commissioning of any power system stabiliser, its preliminary settings shall be agreed by the Network Operator. The User shall propose these preliminary settings that should be derived from system simulation studies and the study results reviewed by the Network Operator.

- (vii) The performance characteristics set out in [Table 7-Figure 7](#) are required for AC exciter, rotating rectifier and static excitation systems.

**Table 7-Figure 7 – Synchronous Generator excitation system performance requirements**

Performance Item	Units	Static Excitation	A.C. Exciter or Rotating Rectifier	Notes
<p><b>Sensitivity:</b> A sustained 0.5% error between the <i>voltage</i> reference and the sensed <i>voltage</i> will produce an excitation <i>change</i> of not less than 1.0 per unit.</p>	Open loop gain (ratio)	200 minimum	200 minimum	1
<p><b>Field <i>voltage</i> rise time:</b> <i>Time</i> for field <i>voltage</i> to rise from rated <i>voltage</i> to excitation ceiling <i>voltage</i> following the application of a short duration impulse to the <i>voltage</i> reference.</p>	second	0.05 maximum	0.5 maximum	2
<p>Settling <i>time</i> with the <i>Generator</i> synchronised following a disturbance equivalent to a 5% step <i>change</i> in the sensed <i>Generator</i> terminal <i>voltage</i>.</p>	second	2.5 maximum	5 maximum	3
<p>Settling <i>time</i> with the <i>Generator</i> unsynchronised following a disturbance equivalent to a 5% step <i>change</i> in the sensed <i>Generator</i> terminal <i>voltage</i>. Shall be met at all operating points within the <i>Generator</i> capability.</p>	second	1.5 maximum	2.5 maximum	3
<p>Settling <i>time</i> following any disturbance that causes an excitation limiter to operate.</p>	second	5 maximum	5 maximum	3
<p><b>Notes:</b></p> <ol style="list-style-type: none"> <li>1. One per unit is that field <i>voltage</i> required to produce nominal <i>voltage</i> on the air gap line of the <i>Generator</i> open circuit characteristic (Refer IEEE Standard 115-1983 – Test Procedures for Synchronous Machines).</li> <li>2. Rated field <i>voltage</i> is that <i>voltage</i> required to give nominal <i>Generator</i> terminal <i>voltage</i> when the <i>Generator</i> is operating at its maximum continuous rating. Rise <i>time</i> is defined as the <i>time</i> taken for the field <i>voltage</i> to rise from 10% to 90% of the increment value.</li> <li>3. Settling <i>time</i> is defined as the <i>time</i> taken for the <i>Generator</i> terminal <i>voltage</i> to settle and stay within an error band of <math>\pm 10\%</math> of its increment value.</li> </ol>				

- (viii) The performance characteristics required for the *voltage* or *reactive power* control systems of all non-synchronous *Generation Units* *generating units* are specified in [Table 8-Figure 8](#).

**Table 8-Figure 8 – Non-synchronous Generator voltage or reactive power control system performance requirements**

Performance Item	Units	Limiting Value	Notes
<b>Sensitivity:</b> A sustained 0.5% error between the reference <i>voltage</i> and the sensed <i>voltage</i> must produce an output change of not less than 100% of the <i>reactive power generation</i> capability of the <i>Generation Unit</i> <i>generating unit</i> , measured at the point of control.	Open loop gain (ratio)	200  minimum	1
<b>Rise time:</b> Time for the controlled parameter ( <i>voltage</i> or <i>reactive power</i> output) to rise from the initial value to 90% of the change between the initial value and the final value following the application of a 5% step change to the <i>control system</i> reference.	second	1.5  maximum	2
<b>Small disturbance settling time</b> Settling time of the controlled parameter with the <i>Generation Unit</i> <i>generating unit</i> connected to the <i>transmission or distribution network</i> following a step change in the <i>control system</i> reference that is not large enough to cause saturation of the controlled output parameter. Must be met at all operating points within the <i>Generation Unit</i> 's <i>generating unit</i> 's capability.	second	2.5  maximum	3
<b>Large disturbance settling time</b> Settling time of the controlled parameter following a large disturbance, including a <i>transmission or distribution network</i> fault, which would cause the maximum value of the controlled output parameter to be just exceeded.	second	5  maximum	3
<b>Notes:</b> <ol style="list-style-type: none"> <li>1. A control system with both proportional and integral actions must be capable of achieving a minimum equivalent gain of 200.</li> <li>2. The controlled parameter and the point where the parameter is to be measured must be agreed and included in the relevant <i>Access Agreement</i> <i>connection agreement</i>.</li> </ol>			

3. Settling time is defined as the time taken for the controlled parameter to settle and stay within an error band of  $\pm 10\%$  of its increment value.

(ix) The *Network Operator* shall approve the structure and parameter settings of all components of the *excitation control system*, including the *voltage regulator*, *power system stabiliser*, power amplifiers and all excitation limiters.

~~(e)~~—The structure and settings of the *excitation control system* shall not be changed, corrected or adjusted in any manner without prior written

- (x) notification to the *Network Operator*. The *Network Operator* may require *Generation Unit-generating unit* tests to demonstrate compliance with the requirements of *Table 7-Figure 7* or *Table 8-Figure 8*. The *Network Operator* may witness such tests.
- (xi) Settings may require alteration from time to time as advised by the *Network Operator* or *Power System Controller*. The cost of altering the settings and verifying subsequent performance shall be borne by the User, provided alterations are not made more than once in each 18 months for each *Generation Unit-generating unit*. If more frequent changes are requested the person making that request shall pay all costs on that occasion.
- (xii) Excitation limiters shall be provided for under excitation and over excitation and may be provided for *voltage to frequency* ratio. The *Generation Unit-generating unit* shall be capable of stable operation for indefinite periods while under the control of any excitation limiter. Excitation limiters shall not detract from the performance of any *stabilising circuits* *power system stabiliser* or *power oscillation damping capability* and shall have settings applied which are co-ordinated with all *protection systems*.

(3) a control system must have:

- (i) for the purposes of disturbance monitoring and testing, permanently installed and operational, monitoring and recording *facilities* for key variables including each input and output; and
- (ii) *facilities* for testing the *control system* sufficient to establish its dynamic operational characteristics.

#### 3.3.5.14 Active Power Control

- (a) Subject to energy source availability, the *active power control automatic access standard* is a *generating system* must have an *active power control system* capable of:
  - (1) Maintaining and changing its *active power* output in accordance with its *dispatch* instructions to the accuracy specified in paragraph (f); and
  - (2) Receiving and automatically responding to AGC signals as updated (nominal update rate of once per four seconds)
- (b) Each control system used to satisfy the requirements of paragraph (a) must be adequately damped.
- (c) Settings may require alteration from time to time as advised by the *Network Operator* or *Power System Controller*. The cost of altering the settings and verifying subsequent performance shall be borne by the *User*, provided alterations are not made more than once in each 18 months for each *generating unit*. If more frequent changes are requested the person making that request shall pay all costs on that occasion.

(d) A generating system must be capable of ramping its active power output linearly at a rate not slower than 5% of nameplate rating per minute.

(e) Active power output of the generating system may differ from dispatch instructions as a result of actions to correct system frequency in accordance with other provisions of this Code.

(f) The active power output of the generating system must be within +/-0.5% of the dispatch instructions subject to [clause 3.3.5.14\(e\)](#), the firm offer in [clause 3.3.5.17](#) and plant ramp rates.

#### 3.3.5.15 Inertia and Contingency FCAS

(a) The inertia and contingency FCAS automatic access standard is:

(1) A generating system must have an adequate inertia and contingency FCAS capability as defined by the characteristic below. Subject to energy source availability, the generating system must be able to operate at a real power output that will deliver inertia and contingency FCAS capability within the adequate zone as shown. The required capability can be achieved by any combination of partially loaded generating unit(s), and/or additional plant (e.g. synchronous condensers, energy storage system, etc.), to achieve the required capability.

(2) Inertia offered or provided from non-synchronous (emulated) sources needs to be assessed and accepted by the Power System Controller and Network Operator.

(3) The inertia and FCAS capabilities will be accredited by the Power System Controller using the specifications and evaluation framework outlined in the System Secure Guidelines.

**Figure 9 – Inertia vs C-FCAS Trade Off Requirements for New Generators**

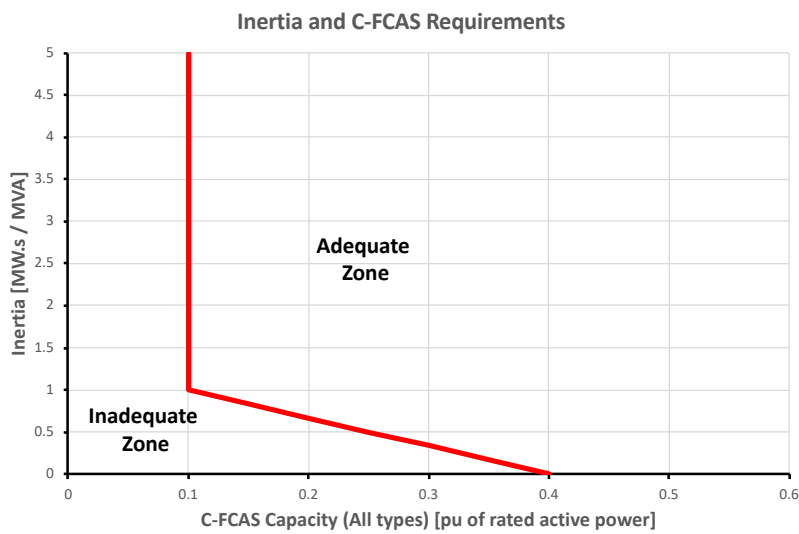

**3.3.5.16 System Strength**

(a) The Network Operator must prepare system strength impact assessment guidelines. In preparing the first version of the guidelines, the Network Operator must review the AEMO System Strength Impact Assessment Guidelines v1.0 July 2018 and adopt those aspects of that document that are appropriate to apply in the Northern Territory together with any other provisions the Network Operator considers appropriate. The Network Operator may amend the guidelines at any time, and must assess the need to amend the guidelines when any changes are made to the AEMO guidelines. The Network Operator must consult with Users before issuing or amending the guidelines.

(a1) Until the Network Operator has developed and published the first version of its system strength impact assessment guidelines, it may undertake assessments based on the relevant provisions of AEMO’s System Strength Impact Assessment Guidelines v1.0 July 2018.

(b) The system strength automatic access standard is a generating system must not cause an adverse impact on system strength as defined in the system strength impact assessment guidelines and following an assessment by the Network Operator.

Subject to paragraph (a):

- (1) a Network Operator must undertake system strength connection works at the cost of the connection applicant if the full assessment undertaken in accordance with the AEMO system strength impact assessment guidelines indicates that the connection applicant's proposed new connection of a generating facility system or the Generator's proposed alteration to a generating system will have an adverse system strength impact ~~adverse system strength impact~~; or
- (2) to the extent that the adverse system strength impact referred to in paragraph (a) is or will be avoided or remedied by a system strength remediation scheme agreed or determined under this clause and implemented by the connection applicant in accordance with its connection agreement.
- (c) A connection applicant proposing to install plant as part of a system strength remediation scheme must include a description of the plant, the ratings of the proposed plant (in MVA) and other information (including models) reasonably required by the Network Operator and Power System Controller to assess the system strength remediation scheme.

#### 3.3.5.17 Capacity Forecasting

- (a) In this clause 3.3.5.17, the following terms apply:
- (1) 't' is time.
  - (2) 't=0' refers to the moment when a forecast is updated.
  - (3) 't=[numeral]' refers to the number of minutes elapsed since t=0.
  - (4) 'capacity' means the minimum capability of a generating system to deliver an active power output at a continuous steady level over the relevant 5 minute interval.
  - (5) 'firm offer' means the capacity forecast provided at t=0 for the interval commencing t=0 for 5 minutes.
- (b) The capacity forecasting automatic access standard is:
- (1) Subject to paragraph (f), a Generator must supply to the Power System Controller a forward forecast of the capacity of its generating system.
  - (2) The forecast in 3.3.5.17(b)(1) must:
    - (i) include a 24 hour ahead forecast for capacity for every 5 minute interval, updated at 5 minute intervals; and
    - (ii) have an accuracy such that in any rolling 24 hour period, at least 90% of the non-zero forecasts for the intervals commencing from t=5 to t= 30 do not exceed the firm offer for the time for which the forecast was made.



- (3) For the forecast updates that do not meet paragraph (2)(ii) above, that exceed the firm offer, the forecast must not exceed the firm offer by a margin greater than:
- (i) 5% of the generating unit's nameplate rating; or
  - (ii) 1 MW,
- whichever is the lesser.
- (4) The firm offer must be the capacity of the generating system for that interval and therefore the generating system must follow a dispatch instruction up to the firm offer in accordance with the requirements in clause 3.3.5.14.
- Note: When issuing dispatch instructions, the System Controller will respect plant limits such as firm offers and ramp rates of plant.*
- (c) A Generator must provide forecasts to the Power System Controller in a format specified by the Power System Controller.
- (d) The generating system owner will be required to report compliance against the above requirements in a format and timeframe determined by the Power System Controller.
- (e) In the event of non-compliance with the automatic access standard by a Generator, the Power System Controller may adjust that Generator's subsequent forecasts and firm offers accordingly.
- (f) The System Controller must publish a procedure that specifies the process the System Controller will use to detect any non-compliance with the capacity forecasting performance standard and the process that will be used to determine the action taken in response to any non-compliance with that performance standard. In formulating this process the System Controller shall publish a proposed draft process and then consult with, and consider the input from interested parties, including the Utilities Commission and Users. The draft procedure must be published by 30 March 2020. Following the required consultation, the final procedure must be published by 8 May 2020.

### **3.3.6 Monitoring and Control Requirements**

#### **3.3.6.1 Remote Monitoring and Control**

(a) The remote monitoring standard is:

- (1) The Network Operator will require Users to provide remote monitoring equipment ("RME") to enable the Network Operator and the Power System Controller to remotely monitor performance of a generating unit (including its dynamic performance) where this is reasonably necessary in real time for control, planning or security of the power system; and

(2) Any RME provided, upgraded, modified or replaced (as applicable) shall conform to an acceptable standard as agreed by the Network Operator and shall be compatible with the Network Operator's SCADA system and the nomenclature standards of the Network Operator and as agreed to by the Power System Controller

(3) Input information to RME may include, but not be limited to, the following:

(i) Status indications:

- a. Generating Unit Circuit Breaker Open/Closed
- b. Remote Generation Load Control on/off
- c. Generating Unit Operating Mode
- d. Governor Limiting Operation
- e. Connection to the network

(ii) Alarms:

- a. Generating Unit Circuit Breaker Tripped by Protection
- b. Prepare to off load

(iii) Protection Defective Alarms

(iv) Measure Values:

- a. Gross active power output of each generating unit
- b. Net station active power import or export at each connection point
- c. Gross reactive power output of each generating unit
- d. Net station reactive power import or export at each connection point
- e. Generating unit stator voltage
- f. Generating unit transformer tap position
- g. Net station output of active energy (impulse)
- h. Generating unit remote Generation control high limit value
- i. Generating unit remote Generation control low limit value
- j. Generating unit remote Generation control rate limit value
- k. For energy storage devices the available energy (in MWh)
- l. Generating unit present maximum active capacity
- m. Generating unit forecasted maximum active capacity

(v) Such other input information as is reasonably required by the Network Operator or Power System Controller.

(4) A User is required to install remote control equipment ("RCE") that is adequate to enable the Power System Controller to remotely control:

- (i) The active power output of any generating unit; and
- (ii) The reactive power output of any generating unit.

- (5) Unless agreed otherwise, the relevant User will be responsible for the following actions at the request of the Network Operator or the Power System Controller:
- (i) Activating and de-activating RCE installed in relation to any generating unit; and
  - (ii) Setting the minimum and maximum levels to which, and a maximum rate at which, the Power System Controller will be able to adjust the performance of any generating unit using RCE.
- (6) A User shall provide electricity supplies for the RME and RCE installed in relation to its generating unit capable of keeping these facilities available for at least eight hours following total loss of supply at the connection point for the relevant generating unit.
- (7) The performance of the RME and RCE in terms of accuracy and reliability shall meet the requirements of the Network Operator and Power System Controller.

#### 3.3.6.2 Communications Equipment

- (a) The communications equipment standard is:
- (1) A User shall provide communications paths (with appropriate redundancy) between RME or RCE installed at any of its generating units to a communications interface at the relevant power station and in a location reasonably acceptable to the Network Operator.
  - (2) Communications systems between this communications interface and the relevant control centre shall be the responsibility of the Network Operator unless otherwise agreed.
  - (3) The User shall meet the cost of the communications systems, unless otherwise determined by the Network Operator.
  - (4) Telecommunications between the Power System Controller and Generators shall be established in accordance with the requirements set down below for operational communications.
    - (i) Primary Speech Facility
      - (A) Each User shall provide and maintain equipment by means of which routine and emergency control telephone calls may be established between the User's responsible Engineer/ Operator and the Power System Controller.
      - (B) The facilities to be provided, including the interface requirement between the Power System Controller's equipment and the User's equipment shall be specified by the Network Operator.
    - (ii) Back-up Speech Facility

(A) Where the Network Operator advises a User that a back-up speech facility to the primary facility is required, the Network Operator will provide and maintain a separate telephone link or radio installation. The costs of the equipment shall be recovered through the charge for connection.

(B) The Network Operator shall be responsible for radio system planning and for obtaining radio licenses for equipment used in relation to the Network Operator networks.

### **3.2.13.3.7 Power station auxiliary ~~transformers~~supplies**

In cases where a ~~power station generating system~~ takes its auxiliary supplies through a ~~transformer~~ via a ~~separate connection point, through which its generation is not transferred to the User shall comply with network,~~ the ~~conditions~~access standards for ~~connection of loads (the auxiliaries must be established under clause 3.6) in respect of that connection point-3.6 as a load customer.~~

#### **3.3.4 Synchronising**

- ~~(a) The User shall provide and install manual or automatic synchronising at the Generator circuit breakers.~~
- ~~(b) Check synchronising shall be provided on all Generator circuit breakers and any other circuit breakers, unless interlocked (as outlined in clause 3.3.1.1), that are capable of connecting the User's Generation Facilities to the network.~~
- ~~(c) Prior to the initial synchronisation of the Generation Unit(s) to the network, the User and the Power System Controller shall agree on the operational procedures necessary for synchronisation.~~

#### **3.3.5 Secure electricity supplies**

~~Secure electricity supplies of adequate capacity to provide for the operation for at least eight hours of plant performing metering, communication, monitoring, and protection functions, on the loss of AC supplies, shall be provided by a User.~~

### **3.3.8 Fault current**

(a) The fault current standard is:

(1) The contribution of the generating system to the fault current on the connecting network through its connection point must not exceed the contribution level that will ensure that the total fault current can be safely interrupted by the circuit breakers of the connecting network and safely carried by the connecting network for the duration of the applicable breaker fail protection system fault clearance times, as specified for the relevant connection point by the Network Operator;

(2) A generating system's connected plant must be capable of withstanding fault current through the connection point up to the higher of:

- (i) The level specified by the *Network Operator*; or
- (ii) The highest level of current at the *connection point* that can be safely interrupted by the circuit breakers of the connecting network and safely carried by the connecting network for the duration of the applicable breaker fail *protection system* fault clearance times, as specified by the *Network Operator*.
- (3) A circuit breaker provided to isolate a *generating unit* or *generating system* from the *network* must be capable of breaking, without damage or restrike, the maximum fault currents that could reasonably be expected to flow through the circuit breaker for any fault in the *network* or in the *generating unit* or *generating system*, as specified in the *connection agreement*.

### **3.3.4 Requirements for connection of Small Generators**

#### **3.3.4.1 Scope**

- (a) This clause 3.4.1-3.4 addresses the requirements for the *connection* of *Small Generation Units* and groups of *Small Generation Units*.
- (b) This clause 3.4.1-3.4 does not apply to the *connection* of *Small Inverter Energy Systems*, in respect of which clause 3.5-3.5 applies.

### 3.3.23.4.2 Objectives

- (a) The issues addressed by this clause [3.4.2-3.4](#) are:
  - (1) the possibility that *Small Generation Units* embedded in *networks* may affect the *quality of supply* to other *Users*, cause reverse *power transfer*, use up *network* capacity, create a *network* switching hazard and increase risks for operational personnel;
  - (2) the possibility that a *Small Generation Unit* connected to a *network* could become islanded on to a de-energised part of the *network* resulting in safety and *quality of supply* concerns; and
  - (3) a simplified *connection* process for *Small Generators*.

### 3.3.33.4.3 Categorisation of facilities

- (a) This clause [3.4.3-3.4](#) covers *Small Generation Units* of all types, whether using renewable or non-renewable *energy* sources.
- (b) Unless otherwise specified, technical requirements for *Small Generation Units* will apply at the *connection point*, rather than at the *Generator* machine terminals, except that the *reactive power* requirements for *synchronous Small Generation Units* will apply at the *Generator* machine terminals.
- (c) *Connection points* for small *power stations* are characterised as:
  - (1) *high voltage connected*: 3 phase, 11-kV or 22-kV; or
  - (2) *low voltage connected*: 1, 2 or 3 phase plus neutral, 230-V or 400-V.
  - (3) Where a *Small Generation Unit* is the only *facility* connected to a *low voltage network* the *Generator* may choose to have the *power station* assessed for compliance as if the *power station* was *high voltage connected*. Prior to another *User* subsequently connecting to the same *low voltage network* the *Network Operator* shall reassess the *power station* for compliance with the requirements for *low voltage connected power stations* and the *Small Generator* shall rectify any noncompliance identified in the reassessment.
- (d) The mode of operation of a *Small Generation Unit* in a small *power station* is characterised as being in:
  - (1) continuous parallel operation with the *network*, and either exporting electricity to the *network* or not exporting electricity to it;
  - (2) occasional parallel operation with the *network*, and either exporting electricity to the *network* or not exporting electricity to it, including *Generation Units/generating units* participating in peak lopping and system *peak load* management for up to 200 hours per year;
  - (3) short term test parallel operation with the *network*, and either exporting electricity to the *network* or not exporting electricity to it, and having a maximum duration of parallel operation 2 hours per event and 24 hours per year; or

- (4) bumpless (make before break) transfer operation, being:
- (i) operation in rapid transfer mode where, when *load* is transferred between the *Small Generation Unit* and the *network* or vice versa, the *Small Generation Unit* is *synchronised* for a maximum of one second per event; or
  - (ii) operation in gradual transfer mode where, when *load* is transferred between the *Small Generation Unit* and the *network* or vice versa, the *Small Generation Unit* is *synchronised* for a maximum of 60 seconds per event.

#### **3.3.4.4 Information to be provided by a Small Generator**

- (a) A *Small Generator* shall provide all information in relation to the design, construction, operation and configuration of that small *power station* as is required by the *Network Operator* to ensure that the operation and performance standards of the *network*, or other *Users*, are not adversely affected by the operation of the *power station*.
- (b) Details of the kinds of information that may be required for *Small Generators* are included in clause ~~11~~ 11.

#### **3.3.4.5 Safety and reliability**

The requirements imposed on a *Small Generator* by this clause ~~3.4.5~~ 3.4.5 are intended to provide minimum safety and *reliability* standards for the *network* and other *Users*.

- (a) A *Small Generator* shall design its *facilities* in accordance with applicable standards and regulations, *good electricity industry practice* and the manufacturers' recommendations.
- (b) The safety and *reliability* of the *network* and the equipment of other *Users* are paramount and *connection* applications shall be evaluated accordingly.
- (c) A *Small Generator* shall not *connect* or *reconnect* to the *network* if the safety and *reliability* of the *network* or *Users* would be placed at risk.
- (d) Where it is apparent that the operation of equipment installed in accordance with the requirements of this clause may have an adverse impact on the operation, safety or performance of the *network*, or on the *quality of supply* to other *Users*, the *Network Operator* shall consult with the *Users* to reach an agreement on an acceptable solution.
- (e) Pursuant to clause ~~3.4.5~~(3.4.5)(d), the *Network Operator* may require the *Small Generator* to test or modify its relevant equipment.
- (f) Unless otherwise agreed in the relevant ~~Access Agreement~~ *connection agreement*, the *Network Operator* may require a *Small Generator* not to operate equipment in abnormal *network* operating conditions.

- (g) Equipment directly *connected* to the *connection point* of a small *power station* shall be rated for the *maximum fault current* at the *connection point* specified in clause ~~2.8~~2.8.
- (h) A *Small Generator* shall ensure that the *maximum fault current* contribution from a *Small Generation Unit* or small *power station* is not of a magnitude that will allow the total fault current at the *connection point* to exceed the levels specified in clause ~~2.8~~2.8 for all normal operating conditions.

### ~~3.3.6~~3.3.6 3.4.6 Small Generation Unit characteristics

- (a) To assist in controlling *network* fault levels, *Small Generators* shall ensure that ~~Generation Units~~generating units comply with the *Network Operator's* requirements relating to *minimum fault current* and *maximum fault current* contribution through a *connection point*.
- (b) If the *connection* or *disconnection* of a *User's* small *power station* causes or is likely to cause excessively high or low fault levels, this shall be addressed by other technical measures specified in the relevant ~~Access Agreement~~connection agreement.

### ~~3.3.7~~3.3.7 3.4.7 Connection and operation

#### ~~3.3.7.1~~3.3.7.1 3.4.7.1 Main switch

- (a) Each *facility* at which a *Small Generation Unit* in a small *power station* is *connected* to the *network* shall contain one main switch provided by the *User* for each *connection point* and one main switch for each *Small Generation Unit*, where a *Small Generation Unit* shares a *connection point* with other *Small Generation Units* or *loads*. For larger installations, additional *connection points* and main switches or a dedicated feeder may be required.
- (a) Switches shall be automatically operated, fault current breaking and making, ganged switches or circuit breakers. The relevant *facility* may also contain similarly rated interposed paralleling switches for the purpose of providing alternative *synchronised* switching operations.
- (b) At each relevant *connection point* there shall be a means of visible and lockable isolation and test points accessible to the *Network Operator's* operational personnel. This may be a withdrawable switch, a switch with visible contacts, a set of removable links or other approved means. It shall be possible for the *Network Operator's* operational personnel to fit safety locks on the isolation point. *Low voltage Small Generation Units* with moulded case circuit breakers and fault limiting fuses with removable links are acceptable for isolation points in accordance with this sub clause.

#### ~~3.4.7.2~~ 3.4.7.2 Synchronising

##### ~~3.4.1.1~~ ~~Synchronising~~



- (a) For a synchronous *Small Generation Unit* in a small power station, a *Small Generator* shall provide automatic *synchronising* equipment at each *Small Generation Unit* circuit breaker.

- (b) Check *synchronising* shall be provided on all *Small Generation Unit* circuit breakers and any other switching devices that are capable of *connecting* the *User's* generating equipment to the *network* unless otherwise interlocked to the satisfaction of the *Network Operator*.
- (c) Prior to the initial *synchronisation* of the *Small Generation Unit(s)* to the *network*, the *Small Generator* and the *Network Operator* shall agree on written operational procedures for *synchronisation*.

#### 3.3.7.23.4.7.3 Safe shutdown without external supply

A *Small Generation Unit* shall be capable of being safely shut down without electricity supply being available from the *network*.

### **3.3.83.4.8 Power quality and voltage change**

- (a) A *Small Generator* shall ensure that the *network* performance standards of clause 2.02 are met when a small *power station* is *connected* by it to the *network*.
- (b) The step *voltage change* at the *connection point* for *connection* and *disconnection* shall comply with the requirements of clause 2.3.3.2.3.3. These requirements may be achieved by *synchronising* individual *Generation Units/generating units* sequentially. On *low voltage* feeders, *voltage changes* up to 5% may be allowed in some circumstances with the approval of the *Network Operator*.
- (c) The steady state *voltage* rise at the *connection point* resulting from export of power to the *network* shall not exceed 2% and shall not cause the *voltage* limits specified in clause 2.3.1.2.3.1 to be exceeded.
- (d) When operating *unsynchronised*, a synchronous *Small Generation Unit* in a small *power station* shall generate a constant *voltage* level with balanced phase *voltages* and harmonic *voltage* distortion equal to or less than permitted in accordance with either *Australian Standard AS 1359 (1997) "General Requirements for Rotating Electrical Machines"* or a recognised relevant international standard, as agreed between the *Network Operator* and the *User*.

### **3.3.93.4.9 Remote control, monitoring and communications**

- (a) For *Small Generation Units* exporting 1-MW or more to the *network* the *Generator* shall provide for:
  - ~~Generator shall provide for:~~
  - (1) tripping of the *Small Generation Unit* remotely from the *Network Operator's* control centre;
  - (2) a close-enable interlock operated from the *Small Network Operator's* control centre; and
  - (3) remote monitoring at the *control centre* of (signed) MW, MVAR and voltage.

(b) For *Small Generation Units* exporting less than 1 MW monitoring may not be required.

- (c) Where concerns for safety and *reliability* arise that are not adequately addressed by automatic *protection systems* and interlocks, the *Network Operator* may require the *Small Generator* to provide remote monitoring and remote control of some functions in accordance with this clause ~~3.4.9~~3.4.9.
- (d) A *Small Generator* shall provide a continuous communication link with the *Network Operator's control centre* for monitoring and control for *Small Generation Units* exporting 1\_MW and above to the *network*. For *Small Generation Units* exporting below 1\_MW, non-continuous monitoring and control may be required ~~eee.g.~~ a *bi-directional* dial up arrangement.
- (e) A *Small Generator* shall have available at all times a telephone link or other communication channel to enable voice communications between a small *power station* and the *Network Operator's control centre*.
- (f) For *Small Generation Units* exporting above 1\_MW, a dedicated telephone link or other dedicated communication channel may be required.

### ~~3.3.10~~3.4.10 Protection

#### ~~3.3.10~~3.4.10.1 General

- (a) A *Small Generator* shall provide, as a minimum, the *protection* functions specified in this clause in accordance with the aggregate rated capacity of *Small Generation Units* in a small *power station* at the *connection point*.
- (b) A *Small Generator's* proposed *protection system* and settings shall be approved by the *Network Operator*, who shall assess their likely effect on the *network* and may specify modified or additional requirements to ensure that:
  - (1) the *network* performance standards specified in clause ~~2.02~~ are met;
  - (2) the *power transfer capability* of the *network* is not reduced; and
  - (3) the *quality of supply* to other *Users* is maintained. Information that may be required by the *Network Operator* prior to giving approval is specified in clause ~~11~~11.
- (c) A *Small Generator's* *protection system* shall clear internal *plant* faults and coordinate with the *Network Operator's* *protection system*.
- (d) The design of a *Small Generator's* *protection system* shall ensure that failure of any *protection device* cannot result in the *network* being placed in an unsafe operating mode or lead to a disturbance or safety risk to the *Network Operator* or to other *Users*. This may be achieved by providing back-up *protection schemes* or designing the *protection system* to be fail-safe, ~~eee.g.~~ to trip on failure.
- (e) All *protection apparatus* shall comply with the IEC 60255 series of standards. Integrated control and *protection apparatus* may be used provided that it can be demonstrated that the *protection* functions are functionally independent of the control functions, ~~iei.e.~~ failure or maloperation of the control features will not impair operation of the *protection system*.

- (f) All *Small Generators* shall provide under and over *voltage*, under and over *frequency* and *overcurrent protection schemes* in accordance with the equipment rating.
- (g) All *Small Generators* shall provide earth fault *protection* for earth faults on the *network*. All small *power stations connected* at high *voltage* shall have a sensitive earth fault *protection scheme*.
- (h) The earth fault *protection scheme* may be:
- (1) earth fault; or
  - (2) neutral *voltage* displacement  
depending on the *connection type*).
- (i) No *Small Generator* may *supply* a de-energised *network* and all small *power stations* shall provide *protection* against abnormal *network* conditions, as specified in ~~clause 3.2.3, clause 3.2.3~~, on one or more phases. This *protection* against loss of external *supply* may be:
- (1) loss of mains;
  - (2) *rate of change of frequency* (ROCOF);
  - (3) vector surge;
  - (4) reverse power; or
  - (5) *directional* over current.
- ~~(j)~~ All *Small Generators* that have an export limit shall have reverse power or
- (j) *directional* current limits set appropriate to the export limit.
- (k) All *Small Generators* shall have loss of AC and DC auxiliary *supply protection*, which shall immediately trip all switches that depend on that *supply* for operation of their *protection*.
- ~~(k)~~ Where *synchronisation* is *time* limited, the *Small Generator* shall be
- (l) *disconnected* by an independent timer.
- (m) *Small Generation Units* that are only operated in parallel with the *network* during rapid bumpless transfer shall be protected by an independent *timer* that will *disconnect* the *Small Generation Unit* from the *network* if the bumpless transfer successfully completed. Automatic transfer switches shall comply with Australian Standard AS 60947.6.2 (2004). For the avoidance of doubt *Small Generation Units* covered by sub-clause ~~3.4.10.1~~(3.4.10.1)(m) need not comply with sub sub-clauses (f) to (l) of clause ~~3.4.10.1-3.4.10.1~~. This exemption recognises that the rapid bumpless transfer will be completed or the *Small Generation Unit* will be *disconnected* by the *disconnection* timer before other *protection schemes* operate. *Protection* of the *Small Generation Unit* when it is not operating in parallel with the *network* is at the discretion of the *Small Generator*.

#### 3.3.10.23.4.10.2 Pole slipping

Where it is determined that the disturbance resulting from loss of synchronism is likely to exceed that permitted in clause 2.6.2.6, the *Small Generator* shall install a pole slipping *protection scheme*.

#### 3.3.10.33.4.10.3 Islanding protection and intertripping

- (a) For sustained parallel operation (which excludes rapid or gradual bumpless transfer), islanding *protection schemes* of two different functional types shall be provided to prevent a *Small Generation Unit* energising a part of the *network* that has become isolated from the remainder of the *transmission* or *network* under all operating modes. The *Small Generator* shall demonstrate that two different functional types of islanding *protection schemes* have been provided.
- (b) *Small Generation Units* designed for gradual bumpless transfer shall be protected with at least one functional type of islanding *protection scheme*.
- (c) Islanding *protection* shall operate within 2 seconds to ensure *disconnection* before the first *network* reclosing attempt (typically 5 seconds). Relay settings are to be agreed with the *Network Operator*. It should be assumed that the *Network Operator* will always attempt to auto-reclose to restore *supply* following transient faults.
- (d) In cases where, in the opinion of the *Network Operator*, the risk of undetected islanding of part of the *network* and the *Small Generator's facility* remains significant, the *Network Operator* may also require the installation of an intertripping link between the *Small Generator's* main switch(es) and the feeder circuit breaker(s) in the zone *substation* or other upstream *protection* device nominated by the *Network Operator*.

#### 3.3.10.43.4.10.4 Protection of Small Generator's equipment

- (a) This clause 3.4.10.43.4.10.4 applies only to *protection* necessary to maintain *power system security*. A *Small Generator* shall design and specify any additional *protection* required to guard against risks within the *Small Generator's facility*.
- (b) Any failure of the *Small Generator's* tripping supplies, *protection apparatus* or circuit breaker trip coils required under clause 3.4.10.3.4.10 shall be alarmed within the *Small Generator's facility* and operating procedures put in place to ensure that prompt action is taken to remedy such failures. As an alternative to alarming, *Small Generation Unit* main switches may be tripped automatically.

### 3.3.113.4.11 Commissioning and testing

The *Small Generator* shall comply with the testing and commissioning requirements for *Small Generation Units* connected to the *network* specified in clause 7.07.

### ~~3.3.123.4.12~~ **3.4.123.4.12** Technical matters to be coordinated

As an alternative to *network augmentation*, the *Network Operator* may require a *Generator* to provide additional *protection schemes* to ensure that operating limits and agreed import and export limits are not exceeded.

### **3.4.13.5** Requirements for connection of Small Inverter Energy Systems

~~The *Network Operator* is not able to enter an *energy buyback agreement* directly. A *User* wishing to enter into such an agreement shall apply to a participating retailer. It should also be noted that whereas this clause 3.5 covers *connection issues* for *Small Inverter Energy Systems* of up to 30 kVA, the maximum capacity that a retailer may be prepared to enter into an *energy buyback agreement* may be less than this amount.~~

The *Network Operator* is not able to enter an *energy buyback agreement* directly. A *User* wishing to enter into such an agreement shall apply to a participating retailer. It should also be noted that whereas this clause 3.5 covers *connection issues* for *Small Inverter Energy Systems* of up to 30 kVA, the maximum capacity that a retailer may be prepared to enter into an *energy buyback agreement* may be less than this amount.

#### **3.4.13.5.1** Scope

- (a) ~~Clause 3.5~~ Clause 3.5 addresses the particular requirements for the *connection* of *Small Inverter Energy Systems* to the *Network Operator's low voltage network*.
- (b) For similarly rated non-Inverter *Energy* systems, the requirements of clause 3.4 for ~~Small Generators~~ apply.  
~~3.4 for Small Generators apply.~~
- (c) The scope of clause ~~3.5~~ 3.5 is limited to technical conditions of *connection*.

#### **3.4.13.5.2** Relevant standards

- ~~(a)~~ The installation of primary *energy* systems shall comply with the relevant
  - (a) ~~Australian Standards~~ and international standards.
  - ~~(b)~~ Inverter systems shall satisfy the requirements of *Australian Standard*
    - (b) ~~AS 4777~~ "Grid connection of energy systems via inverters" as published and revised. The following parts of this standard apply:
      - (1) AS 4777.1 – 2005 Part 1 Installation requirements.
      - (2) AS 4777.2 – 2005 Part 2 Inverter requirements.
      - (3) AS 4777.3 – 2005 Part 3 Grid protection requirements.
  - (c) The term 'Inverter *Energy* system' in these Rules has the same meaning as in ~~Australian Standard AS 4777~~.  
~~Australian Standard AS 4777~~.

- (d) -A type-test report or type-test certificate from an independent and recognised certification body showing compliance of inverter *plant* with *Australian Standard AS-4777.2 (2005)* shall be supplied to the *Network Operator*.
- (e) -Should it be necessary to *change* any parameter of the equipment as installed and contracted, approval shall be sought from the *Network Operator*. Subsequently, the *Network Operator* shall determine whether a revised application is required.



### **3.4.33.5.3 Metering installation**

The *User* shall make provision for import and export *metering* in accordance with the requirements of ~~clause 10.4~~ the NT NER Chapter 7A.

### **3.4.43.5.4 Safety**

- (a) Installations shall comply with the relevant *Australian Standards* and all statutory requirements including Australian Standards AS/NZS 3000, AS/NZS 5033 and *Power and Water's* Power Networks Service Rules and Power Networks Installation Rules.
- (b) All electrical installation, commissioning and maintenance work wherever required shall be carried out by an electrical contractor licensed under the *Northern Territory Electrical Workers and Contractors Act*, as in force at ~~25 November 2014~~ July 2016.

### **3.4.53.5.5 Security of operational settings**

Where operational settings are applied via a keypad or switches, adequate security shall be employed to prevent tampering or inadvertent/unauthorised *changes* to these settings. A suitable lock or password system shall be used. The *Network Operator* shall approve *changes* to settings prior to implementation.

### **3.4.63.5.6 Circuit arrangements**

#### **3.4.6-13.5.6.1 Schematic diagram**

A durable single sided schematic-wiring diagram of the installation showing all equipment and switches shall be affixed on the site adjacent the inverter system.

### **3.4.73.5.7 Protection**

- (a) A *Small Inverter Energy System* connected to the *network* shall be approved by the *Network Operator* and meet the requirements of relevant standards in accordance with clause ~~3.5.2~~ 3.5.2 and the following requirements below.
  - ~~(a)~~ The *User* shall provide the information required by the *Network Operator*
  - (b) prior to approval being given.

#### **3.4.7-13.5.7.1 Islanding protection**

The islanding function shall be automatic and shall physically remove the *Small Inverter Energy System* from the *network*. The Islanding protection shall be capable of detecting loss of supply from the network and disconnect the Small Inverter Energy System from the network within 2 seconds.

3.5.7.2 Synchronising

~~3.4.7.21.1.1.1 Synchronising~~

Connection to the *network* shall be automated. The protective apparatus shall be capable of confirming that the *supply voltage* and *frequency* is within limits for no less than one minute prior to *synchronisation*.

### 3.4.7.33.5.7.3 Reconnection to network

Reconnection to the *network* shall be automated. The protective apparatus shall be capable of confirming that the *supply voltage* and *frequency* are within limits for no less than one minute prior to *synchronisation*.

### 3.4.7.43.5.7.4 Overcurrent protection

Overcurrent *protection* shall be provided at the isolating switch of a *Small Inverter Energy System* in accordance with the equipment rating, unless otherwise agreed with the *Network Operator*.

### 3.4.7.53.5.7.5 Voltage limits

- (a) The Inverter *voltage* limits shall be set according to equipment capability and [Australian Standard AS 4777](#).  
~~Australian Standard AS 4777.~~
- (b) The *Small Inverter Energy System* shall remain *connected* for *voltage* variations within the limits of ~~Table 9~~ [Figure 10](#) ~~Figure 10~~ unless otherwise agreed with the *Network Operator*. The *network voltage* range is based on 5-minute averages of the RMS value.

~~Table 9~~ [Figure 10](#) - *Low voltage limits for Small Inverter Energy Systems*

Nominal voltage	Lower limit	Upper limit
230_V	226_V	254_V
400_V	390_V	440_V

- (c) The *Network Operator* is not responsible for failure of the *Small Inverter Energy System* to remain *connected* for the full range of *voltage* on the *network* set out in ~~Table 9~~ [Figure 10](#) ~~Figure 10~~.

### 3.4.7.63.5.7.6 Frequency limits

- (a) The Inverter *frequency* limits shall be set according to the equipment capability and [Australian Standard AS 4777](#).
- (b) The *Small Inverter Energy System* shall remain *connected* for *frequency* variations between 47.5\_Hz and 52\_Hz unless otherwise agreed with *Network Operator*.

## **3.4.83.5.8 Commissioning and testing**

### 3.4.8.13.5.8.1 Commissioning

- (a) Commissioning may occur only after the installation of the *metering equipment*.

| (b) In commissioning equipment installed under clause [3.5.8,3.5.8](#), a *User* shall verify that:

- (1) The approved schematic has been checked and accurately reflects the installed electrical system.

- (2) All required switches present and operate correctly as per the approved schematic.
  - (3) Signage and labelling comply with that specified in *Power and Water's Service Rules*.
  - (4) The installation is correct and fit for purpose.
  - (5) Operational settings are secure as specified.
  - (6) The islanding *protection* operates correctly and *disconnects* the Inverter Energy system from the network within 2 seconds.  
~~Energy system from the network within 2 seconds.~~
  - (7) The delay in *reconnection* following restoration of normal *supply* is greater than 1 minute.
- (c) Subsequent modifications to the inverter installation shall be submitted to the *Network Operator* for approval.

#### 3.4.8.23.5.8.2 Re-confirmation of correct operation

- (a) The *Network Operator* may elect to inspect the proposed *Small Inverter Energy System* from *time to time* to ensure continued compliance with these requirements. In the event that the *Network Operator* considers that the installation poses a threat to safety, to *quality of supply* or to the integrity of the *network* it may *disconnect* the generating equipment.
- (c) ~~(e)~~ *Small Inverter Energy System protection systems* shall also be tested for correct functioning at regular intervals not exceeding 5 years. The *User* shall arrange for a suitably qualified person to conduct the tests. Results of tests shall be certified by a competent person and supplied to the *Network Operator*.

### **3.5.3.6** Requirements for connection of loads

The following requirements apply to the *connection of loads to networks*.

- (a) These requirements and particular provisions may be waived for smaller *Users* and *Users* that have no potential to affect other *Users*, at the discretion of the *Network Operator*.
- (b) Nothing in this clause ~~3.6~~ 3.6 waives the requirements for all installations to comply with the *Network Operator's Service and Installation Rules, Metering Manual, Contractor's Bulletins*, and any requirement included in ~~an Access Agreement~~ a connection agreement.

#### **3.5.13.6.1** Connection point for a User

*Connection points* between a *User's facility* and a *network* will be defined in the connection agreement.

~~Access Agreement~~

### **3.5.23.6.2 Information**

Before any new or additional equipment is *connected*, the *User* may be required to submit information to the *Network Operator* in accordance with clause [4411](#).

### 3.5.33.6.3 Design standards

~~Changes to the power system may result in the requirements for connected equipment changing. For example, as additional plant is connected to the power system fault levels will increase and the User's plant may no longer be suitable for connection to the system.~~

~~Changes to the power system may result in the requirements for connected equipment changing. For example, as additional plant is connected to the power system fault levels will increase and the User's plant may no longer be suitable for connection to the system.~~

- (a) A User's installation shall comply with the relevant *Australian Standards* as applicable at the *time*, *good electricity industry practice* and this *Code*, including, but not limited to, the *quality of supply* standards as specified in clause ~~2.4.2.4~~.
- ~~(a)~~ All *plant* ratings shall co-ordinate with the equipment installed on the
- (b) *Network Operator* power system.
- (c) *Users* will be responsible for ensuring that *plant* capabilities and ratings are monitored on an ongoing basis to ensure continued suitability as conditions on the power system change.
- (d) A *User* will be responsible for the cost of any *plant* upgrades required at its *facilities* as a result of changing *power system* conditions.
- (e) If, after installation of a *User's facilities*, it is found that the installation is adversely affecting:
- (1) the security or *reliability* of the *power system*;
  - (2) the *quality of supply*; or
  - (3) the installation does not comply with the *Code* or the relevant ~~*Access Agreement*~~ *connection agreement*;
- the *User* shall be responsible for remedying the problem at the *User's* cost, and within a *time* frame reasonably required by the *Network Operator*.

### 3.5.43.6.4 Users' protection systems that impact on power system security

- (a) Where a *User connection* to the *network* may affect *power system security*, the *protection systems* of the *User's connection* shall comply with the requirements of clause ~~3.2.3.3.2.3~~.
- ~~(a)~~ Protection of the *connection* equipment solely for the *User's* risks is at the
- (b) *User's* discretion.

### **3.5.53.6.5 Thermal limits**

The thermal ratings of the *network* components shall comply with the specifications set out in clause ~~15.3~~ 15.3 of the *Network Planning Criteria*.

### **3.5.63.6.6 Fault limits**

The calculated fault levels in the *networks* shall not exceed 95% of the equipment fault ratings set out in clause ~~15.4~~ 15.4 of the *Network Planning Criteria*.



### 3.5.7.3.6.7 Power factor requirements

The power factor of a load connection affects the required capacity of the network to supply the load and the management of voltage conditions on the network.

Power factor improvement may be achieved by installing additional reactive plant or reaching a commercial agreement with the Network Operator to install, operate and maintain equivalent reactive plant as part of connection assets.

The power factor of a load connection affects the required capacity of the network to supply the load and the management of voltage conditions on the network.

Power factor improvement may be achieved by installing additional reactive plant or reaching a commercial agreement with the Network Operator to install, operate and maintain equivalent reactive plant as part of connection assets.

- (a) Power factor ranges to be met by Users for their loads are shown in the ~~Table 10~~ [Figure 11](#) ~~Figure 11~~.

~~Table 10~~ [Figure 11](#) - Power factor requirements (Loads)

Supply Voltage (nominal)	Permissible Power factor Range (half-hour average, unless otherwise specified by the Network Operator)
132-kV / 66-kV	0.95 lagging to unity
<66-kV	0.9 lagging to 0.9 leading

- (b) The Network Operator may permit a lower lagging or leading power factor where this will not reduce system security and/or quality of supply, or require a higher lagging or leading power factor to achieve required power transfers.
- (c) If the power factor falls outside the range in the table over any critical loading period nominated by the Network Operator, the User shall, where required by the Network Operator in order to economically achieve required power transfer levels, take action to ensure that the power factor falls within range as soon as reasonably practical.
- (d) A User who installs static var compensator systems for either power factor or quality of supply requirements shall ensure its control system does not interfere with other normal control functions on the electricity network. Adequate filtering facilities shall be provided if reasonably required by the Network Operator to absorb any excessive harmonic currents.

## 4 Power system ~~security~~operation support

~~This section 4 of the *Network Technical Code* establishes requirements relating to the operation of the electricity network (including the operation of the network in emergency situations). It applies to the *Network Operator*, the *Power System Controller* and all network *Users*.~~

~~The *Power System Controller* has responsibility for control of the day-to-day dispatch of generators and associated ancillary services and for maintaining power system security.~~

~~The following related operational matters are set out in the *System Control Technical Code*:~~

- ~~(a) — operating protocols;~~
- ~~(b) — arrangements for system security and dispatch;~~
- ~~(c) — arrangements for disconnection; and~~
- ~~(d) — any other matters necessary to the efficient operation, monitoring and control of the *power system*.~~

### 1.3 — Introduction

#### 4.1.1 — Purpose and application ~~This section 04 of clause 4~~

- ~~(a) — Clause 4 the *Network Technical Code* establishes requirements relating to the operation of the *Code* electricity network (including the operation of the network in emergency situations). It applies to, and defines obligations for all *Users*, including:
  - ~~(1) — the framework for achieving and maintaining a secure *power system*;~~
  - ~~(2) — the conditions under which the *Power System Controller* can issue directions to *Users* so as to maintain or re-establish a secure *power system*.~~~~
- ~~(b) — By virtue of this clause 4, the *Power System Controller* has the responsibility to maintain *power system security* within the design and operating limits determined by the *Network Operator*.~~

### 1.4 — Power system security principles

~~This clause 4.2 sets out certain definitions and concepts that are relevant to *power system security*.~~

#### 4.2.1 — Power system operating state

- ~~(a) — The *Power System Controller* shall define the operating states of the power system in the *System Control Technical Code*:
  - ~~(1) — and all *satisfactory operating state*; and~~
  - ~~(2) — *secure operating state*.~~~~

~~(b) The definition of operating states in section 4.2.1(a) shall be in accordance with:~~

~~(1) operating frequency requirements set out in clause 2.2 of this Code;~~

- (2) ~~voltage requirements set out in clause 2.3 of this Code;~~
- (3) ~~current flows for lines and equipment within the ratings defined by the Network Operator;~~
- (4) ~~the power system stability requirements set out in clause 2.6; and~~
- (5) ~~the technical envelope of power system performance set out in clause 4.2.2.~~

#### ~~4.2.2~~—Technical envelope

- (a) ~~The technical envelope means the technical boundary limits of the power system for achieving and maintaining the secure operating state of the power system for a given demand and power system scenario.~~

~~The Network Operator shall determine and revise the technical envelope (as may be necessary from time to time) by taking into account the prevailing power system and plant conditions as described in clause 4.2.2(c) Users.~~

- (b) ~~The technical envelope determination shall take into account matters including but not limited to:~~
  - (1) ~~the Network Operator forecast total power system load;~~
  - (2) ~~the provision of the applicable contingency capacity reserves;~~
  - (3) ~~operation within all plant capabilities and constraints on the power system;~~
  - (4) ~~contingency capacity reserves available to handle credible contingency events in accordance with clauses 2.6 and 2.7 of this Code;~~
  - (5) ~~agreed Generation load constraints;~~
  - (6) ~~constraints on the network, including short term limitations;~~
  - (7) ~~frequency control requirements;~~
  - (8) ~~reactive power support and ancillary services requirements; and~~
  - (9) ~~the existence of proposals for any major equipment or plant testing, including the checking of or possible changes in plant availability.~~

#### ~~4.2.3~~—General principles for maintaining power system security

~~The power system security principles are as follows:~~

- (a) ~~To the extent practical, the Power System Controller shall operate the power system such that it is and will remain in a secure operating state.~~
- (b) ~~Following a credible contingency event or a non-credible contingency event, the power system may no longer be in a secure condition on the occurrence of a further contingency event. In that case, the Power System Controller shall take all reasonable actions to return the power system to its satisfactory operating state as soon as practical, in accordance with the System Control Technical Code.~~

- ~~(c) The Network Operator shall ensure the provision of adequate *load-shedding* facilities initiated automatically by *frequency* or *voltage* conditions outside the normal operating *frequency* or *voltage* excursion band to restore the *power system* to a *satisfactory operating state* following a significant *contingency event*.~~
- ~~(d) The *Power System Controller* shall ensure adequate *load-shedding* facilities are in service to restore the *power system* to a *satisfactory operating state* following a significant *contingency event*.~~
- ~~(e) A *User* shall be required, either under their *Access Agreement* or *ancillary services agreement*, to provide and maintain all required facilities consistent with both their *Access Agreement* and *good electricity industry practice* and operate their equipment in a manner:~~
- ~~(1) to assist in preventing or controlling instability within the *power system*;~~
  - ~~(2) to assist in the maintenance of, or restoration to a *satisfactory operating state* of the *power system*;~~
  - ~~(3) to prevent uncontrolled separation of the *transmission network* into isolated *regions* or partly combined *regions*, *intra-regional transmission break up*, or *cascading outages*, following any *power system* incident; and~~
  - ~~(4) in accordance with the technical requirements of their *Access Agreement*.~~
- ~~(f) *Users* shall arrange sufficient black start up provisions so as to allow the restoration and any necessary restarting of their *Generation Units* following a *black system* condition.~~

## ~~1.5 — Power system security obligations and responsibilities~~

### ~~4.3.1 — Time for undertaking action~~

~~An event which is required under this clause 4 of the *Code* to occur on or by a stipulated *day* shall occur on or by that *day* whether or not a *business day*.~~

## ~~4.1 [Deleted]~~

## ~~4.2 [Deleted]~~

## ~~4.3 Responsibilities~~

### ~~4.3.1 [Deleted]~~

#### ~~4.1.14.3.2 Network Operator~~

- (a) The *Network Operator* shall use its reasonable endeavours, including through the provision of appropriate information to *Users* to the extent permitted by law and under this *Code*, to ensure that:
- (1) the *power system*;
  - (2) *network* equipment;

(3) *network connections*; and

(4) *User equipment*;

are specified, planned and developed in accordance with *power system security* principles and *good electricity industry practice*.

~~(a)~~—Where an obligation is imposed on the *Network Operator* under this clause of the *Code* to arrange or control any act, matter or thing or to ensure that any other person undertakes or refrains from any act, that obligation is limited to

- (b) a requirement for the *Network Operator* to use reasonable endeavours, including to give such *directions* as are within its powers, to comply with that obligation.
- (c) If the *Network Operator* fails to arrange or control any act, matter or thing or the acts of any other person notwithstanding the use of the *Network Operator's* reasonable endeavours, the *Network Operator* will not be taken to have breached such obligation.
- (d) The *Network Operator* shall make accessible to *Users* such information as:
  - (1) the *Network Operator* considers appropriate;
  - (2) the *Network Operator* is permitted to disclose in order to assist *Users* to make appropriate market decisions related to open access to the *Network Operator's networks*; and
  - (3) the *Network Operator* is able to disclose to enable *Users* to consider initiating procedures to manage the potential risk of any necessary action by the *Network Operator* to restore or maintain *power system security*.
- (e) In making information available in accordance with clause ~~4.3.2~~4.3.2(d), the *Network Operator* shall use reasonable endeavours to ensure that such information is available to those *Users* who request the information on an equivalent basis.
- (f) In the event that the *Network Operator*, in its reasonable opinion for reasons of safety to the public, the *Network Operator* personnel, *Users'* equipment or the *Network Operator* equipment ~~or for power system security~~, needs to interrupt supply to any *User*, the *Network Operator* will (time permitting) consult with the relevant *User* and as applicable, the *Power System Controller* prior to executing that interruption.
- (g) The *Network Operator* in consultation with the *Power System Controller* shall arrange controls, monitoring and secure communication systems which are appropriate in the circumstances to facilitate a manually initiated, rotational *load shedding* and restoration process ~~which may be necessary if there is, in the *Network Operator's* opinion, a prolonged major power system disruption.~~

#### 4.3.2 — Power System Controller

~~The *Power System Controller* shall:~~

- ~~(a) Take reasonable steps to ensure that high voltage switching procedures and arrangements are utilised by *Users* to provide adequate protection of the power system.~~
- ~~(b) Assess potential infringement of the technical envelope or power system operating procedures that could affect the security of the power system.~~
- ~~(c) Operate the power system within the limits of the technical envelope.~~

- ~~(d) Operate all *plant* and equipment under its control or co-ordination within the appropriate operational or emergency limits that are either established by the *Network Operator* or advised by the respective *User*.~~
- ~~(e) Assess the impacts of any technical and operational *constraints* on the operation of the *power system*.~~
- ~~(f) Monitor the *dispatch* of *Generation Units* and *associated loads* to ensure they stay within both their allowable limits and the dynamic limits of the *technical envelope*.~~
- ~~(g) Determine any potential *constraint* on the operation of *Generation Units* and *loads* and to assess the effect of this *constraint* on the maintenance of *power system security*.~~
- ~~(h) Assess the availability and adequacy, including the dynamic response, of *contingency capacity reserves* and *reactive power reserves* in accordance with clause 2 of this Code and to take reasonable steps to ensure that appropriate levels of *contingency capacity reserves* and *reactive power reserves* are available:
  - ~~(1) to ensure the *power system* is, and is maintained, in a *satisfactory operating state*; and~~
  - ~~(2) to arrest the impacts of a range of significant multiple *contingency events* (affecting up to 90% of the total *power system load*) to allow a prompt restoration or recovery of *power system security*, taking into account *under frequency* or *under voltage* initiated *load shedding* capability provided under *Access Agreements* or as otherwise.~~~~
- ~~(i) Make available to *Users* as appropriate, information about the potential for, or the occurrence of, a situation that could significantly impact, or is significantly impacting on *power system security*.~~
- ~~(j) Refer to other *Users*, as the *Power System Controller* deems appropriate, information of which the *Power System Controller* becomes aware in relation to significant risks to the *power system* where actions to achieve a resolution of those risks are outside the responsibility or control of the *Network Operator*.~~
- ~~(k) Determine the extent to which the levels of *contingency capacity reserves* and *reactive power reserves* are or were appropriate through appropriate testing, auditing and simulation studies.~~
- ~~(l) Utilise resources and services provided or procured as *ancillary services* or otherwise to maintain or restore the *satisfactory operating state* of the *power system*.~~
- ~~(m) Co-ordinate the operation of *black start-up facilities* in response to a partial or total *black system* condition sufficient to re-establish a *satisfactory operating state* of the *power system*.~~



- ~~(n) Interrupt, subject to this clause 4.3.3, Users' connections as necessary during emergency situations to facilitate the re-establishment of the satisfactory operating state of the power system.~~
- ~~(o) Direct (as necessary) any Users to take action necessary to ensure, maintain or restore the power system to a satisfactory operating state.~~
- ~~(p) Co-ordinate and direct any rotation of widespread interruption of demand in the event of a major supply shortfall or disruption.~~
- ~~(q) Investigate and review all major power system operational incidents and to initiate action plans to manage any abnormal situations or significant deficiencies that could reasonably threaten power system security. All Users shall co-operate with such action plans at their own cost. Such situations or deficiencies include without limitation:
  - ~~(1) power system frequencies outside those specified in the definition of satisfactory operating state;~~
  - ~~(2) power system voltages outside those specified in the definition of satisfactory operating state;~~
  - ~~(3) actual or potential power system instability; and~~
  - ~~(4) unplanned/unexpected operation of major power system equipment.~~~~

### 4.3.3 Network [Deleted]

### 4.1-24.3.4 Users

- (a) All Users shall co-operate with and assist the Power System Controller in the proper discharge of the Power System Controller's power system security responsibilities.
- (b) All Users shall operate their facilities and equipment in accordance with any reasonable direction given by the Power System Controller.
- (c) All Users shall provide automatic interruptible load of the type described in clause ~~3.2.8.3.2.8~~. The level of this automatic interruptible load will be a minimum of 75% of their expected demand, or such other minimum interruptible load level as may be periodically determined by the Network Operator in accordance with clause ~~3.2.8.3.2.8~~.
- (d) Users shall provide their interruptible load in manageable blocks spread over a number of steps within under frequency bands from 49.25 Hz down to 48.50 Hz as nominated by the Power System Controller.  
~~48.50 Hz as nominated by the Network Operator.~~

## 4.4 ~~Power system frequency~~ **[Deleted]**

### 4.24.5 **Voltage control**

#### ~~4.4.1~~ ~~Power system frequency control responsibilities~~

~~The Power System Controller shall use its reasonable endeavours to:~~

- ~~(a) Control the power system frequency and associated time error in accordance with clause 2.2; and~~

~~(b) Ensure that the power system frequency operating standards set out in clause 2.2.1 of this Code are achieved.~~

#### ~~4.4.2—Operational frequency control requirements~~

~~To assist in the effective monitoring of power system frequency by the Power System Controller the following provisions apply:~~

- ~~(a) The authority to control and direct the output of all Generation Units and supply to loads is given to the Power System Controller pursuant to clause 9.1.~~
- ~~(b) Each User shall ensure that all of its Generation Units have automatic and responsive speed governor systems and automatic load control schemes in accordance with the requirements of clause 3.3, so as to automatically adjust for changes in associated power demand or loss of Generation as it occurs through response to the resulting excursion in power system frequency and associated load.~~
- ~~(c) The Power System Controller shall use its reasonable endeavours to arrange to be available and specifically allocated to regulating duty such Generation Facilities as the Power System Controller considers appropriate which can be automatically controlled or directed by the Power System Controller to ensure that normal load variations do not result in frequency deviations outside the limitations specified in clause 2.2.1.~~
- ~~(d) The Power System Controller shall use its reasonable endeavours to arrange ancillary services and contractual arrangements associated with the availability, responsiveness and control of necessary contingency capacity reserve and the rapid unloading of Generation as may be reasonably necessary to cater for the impact on the power system frequency of potential power system disruptions ranging from the critical single credible contingency event to the most serious contingency events.~~
- ~~(e) The Power System Controller shall use its reasonable endeavours to ensure that adequate facilities are available and are under the direction of the Power System Controller to allow the managed recovery of the satisfactory operating state of the power system.~~

#### ~~1.6—Control of network voltages~~

### ~~4.2.14.5.1~~ Network voltage control

- (a) The Network Operator shall determine the adequacy of the capacity to produce or absorb reactive power in the control of the network voltages.
- (b) The Network Operator shall assess and determine the limits of the operation of the network associated with the avoidance of voltage failure or collapse under credible contingency event scenarios.
- (c) The limits of operation of the network shall be translated by the Network Operator, into key location operational voltage settings or limits, power line capacity limits, reactive power production (or absorption) capacity or other

appropriate limits to enable their use by the *Power System Controller* in the maintenance of *power system security*.

~~appropriate limits to enable their use by the Power System Controller in the maintenance of power system security.~~

(d) The determination referred to in clause ~~4.5.1(4.5.1)~~(b) shall include a review of the dynamic stability of the voltage of the transmission network.

~~(a) The Power System Controller shall use its reasonable endeavours to maintain voltage conditions throughout the network in accordance with the technical requirements specified in clause 2.~~

~~(e) The limits determined in paragraph (c) shall be, subject to consultation, included in the System Secure Guidelines.~~

~~(e)~~(f) The Network Operator shall use its reasonable endeavours to arrange the provision of reactive power facilities and power system voltage stabilising facilities through:

- (1) contractual arrangements for ancillary services with appropriate Users;
- (2) obligations on the part of Users; or under their ~~Access Agreements~~ connection agreements;
- (3) provision of such facilities by the Network Operator.

~~(f)~~(g) Without limitation, such reactive power facilities may include:

- (1) synchronous Generator voltage controls usually associated with tap-changing transformers; or Generator AVR set point control (rotor current adjustment);
- (2) synchronous condensers (compensators);
- (3) static var compensators (SVC);
- (4) shunt capacitors;
- (5) shunt reactors;
- (6) series capacitors.

#### 4.5.2 Reactive power reserve requirements

~~(a) The Power System Controller shall use its reasonable endeavours to ensure that sufficient reactive power reserve is available at all times to maintain or restore the power system to a satisfactory operating state after the most critical contingency event as determined by previous analysis or by periodic contingency analysis by the Power System Controller.~~

~~(b) If voltages fall outside acceptable limits, and the means of voltage control set out in this clause 4.5.2 are exhausted, the Power System Controller shall take all reasonable actions, including to direct changes to demand (through selective load shedding from the power system), additional Generation operation or reduction in the transmission line flows but only to the extent necessary to restore the voltages to within the relevant limits.~~

~~(c) A User shall comply with any direction made by the Power System Controller under this clause 4.5.2.~~

~~4.7~~ Power system operating procedures

- ~~(a) The Power System Controller shall be responsible for developing and maintaining power system operating procedures including, but not limited to:~~
- ~~(1) basic electrical safety requirements;~~
  - ~~(2) electrical safety instructions;~~
  - ~~(3) general operating/field procedures; and~~
  - ~~(4) station specific procedures related to the operation of the power system in that station.~~
- ~~(b) The nature and effect of the power system operating procedures shall be set out in the System Control Technical Code.~~

**4.5.2 [Deleted]**

**4.34.6 Network operations and power system security support**

- ~~(a) The Power System Controller shall conduct or direct operations on the network in accordance with the appropriate power system operating procedures, the System Control Technical Code and good electricity industry practice.~~

**4.6.1 Network operations**

~~(a) [Deleted]~~

~~(a)~~**(b)** Users shall operate their equipment interfacing with the network in accordance with the requirements of:

- (1) this Code;
- (2) any applicable ~~Access Agreement~~ connection agreement or ancillary services agreement;
- (3) the requirements of the System Control Technical Code and the Network Operator's Electrical Safety Manual; and
- (4) the relevant power system operating procedures.

~~(b)~~**(c)** Users shall ensure that network operations performed on their behalf are undertaken by competent persons.

**4.3.14.6.2 Switching of reactive power facilities**

~~(a) The Power System Controller may instruct [Deleted]~~

~~(b) Where a User and the Network Operator have made prior arrangements in relation to place reactive facilities belonging to or controlled by that User into or out of service for the purposes of maintaining matters associated with power system security where prior arrangements concerning these matters have been made between the Network Operator and a User.~~

~~(a)(b)~~ Without limitation to its obligations under such prior arrangements, ~~as support, the~~ User shall use reasonable endeavours to comply with ~~such an instruction~~ relevant instructions given by the *Network Operator* or its authorised agent.

#### ~~4.6.2~~ — Generation limits

~~Limits to the VAr Generation and absorption capability of Generation Facilities and reactive compensation plant such as static var compensators are not to be exceeded.~~

### 4.6.3 ~~Power~~[Deleted]

### 4.44.7 Other system security operations support measures

#### 4.7.1 ~~Users' advice~~

~~A User shall promptly advise the Power System Controller at the time that the User becomes aware of any circumstance that could be expected to adversely affect the secure operation of the power system or any equipment owned or under the control of the User.~~

#### 4.7.2 ~~Protection or control system abnormality~~

- ~~(a) If a User becomes aware that any relevant protection or control system is defective or unavailable for service, that User shall advise the Power System Controller in accordance with the requirements of the System Control Technical Code.~~
- ~~(b) If the Power System Controller considers the unavailability of the protection system in 4.7.2(a) to be a threat to power system security, the Power System Controller may direct that the equipment protected or operated by the relevant protection or control system be taken out of operation or operated as the Power System Controller directs.~~
- ~~(c) A User shall comply with a direction given by the Power System Controller under clause 4.7.2(b) at no cost to the Power System Controller.~~

#### 4.7.3 ~~Power System Controller advice on power system emergency conditions~~

- ~~(a) The Power System Controller shall advise affected or potentially affected Users of all relevant details promptly after the Power System Controller becomes aware of any circumstance with respect to the power system which, in the reasonable opinion of the Power System Controller could be expected to materially adversely affect supply to or from Users.~~
- ~~(b) Without limitation, such circumstances may include:
  - ~~(1) electricity capacity shortfall, being a condition where there are insufficient network or supply options available to enable the secure supply of the total load in a region;~~
  - ~~(2) unexpected disruption of power system security, which may occur when:
    - ~~(iv) an unanticipated major power system contingency event occurs;~~
    - ~~or~~
    - ~~(v) significant environmental or similar conditions, including weather, storms or fires, are likely to, or are affecting the power system; or~~~~
  - ~~(3) a black system condition.~~~~



#### 4.7.4 — Managing a power system contingency event

- ~~(a) During the period when the power system is affected by a contingency event the Power System Controller shall carry out actions, in accordance with the guidelines set out in this Code and the System Control Technical Code to:~~
- ~~(1) identify the impact of the contingency event on power system security in terms of the capability of the network;~~
  - ~~(2) identify and implement the actions required in each affected region to restore the power system to its satisfactory operating state.~~
- ~~(b) When contingency events lead to potential or actual electricity supply shortfall events, the Power System Controller shall follow the procedures outlined in clause 4.7.~~

#### 4.7.1 [Deleted]

#### 4.7.2 [Deleted]

#### 4.7.3 [Deleted]

#### 4.7.4 [Deleted]

#### 4.4.14.7.5 Managing electricity supply shortfall events

- ~~(a) If, at any time, there are insufficient supply options available to securely supply total load in a region, then, as advised by the Power System Controller may undertake all or any of, the following:~~
- ~~(1) recall of equipment outages;~~
  - ~~(2) disconnect one or more points of load connection as the Power System Controller considers necessary;~~
- (a) Network Operator shall direct a User to take such steps as are reasonable to immediately reduce its load.
- (b) A User shall use all reasonable endeavours to comply with a noticedirection given under clause 4.7.5(4.7.5(a)(3)).

#### 4.7.6 Directions by the Network Operator

- ~~(b) If there is the Network Operator, acting in response to a major supply shortfall, direction from the Power System Controller shall implement, to the extent practical, a sharing of load shedding across interconnected regions up to the power transfer capability of the network.~~

#### 4.7.5 — Directions by the Power System Controller affecting power system security

~~Subject to the Power System Controller giving, requires a User a reasonable period of time~~

~~to take appropriate action:~~

~~(a) The Power System Controller may give reasonable directions to any User in accordance with the provisions of the System Control Technical Code requiring the User to do any act or thing which the Network Operator considers is considered reasonably necessary to ensure the security of the power system-~~  
~~(a) A and compliance with this Code, a User shall use all reasonable endeavours to comply within a reasonable period of time with any such directions given to it by the Network Operator.~~

~~(a)~~(b) If a User does not comply with a direction within a reasonable period of time and as such a satisfactory operating state cannot be re-established, the Network Operator may disconnect the User without further recourse.

#### 4.4.24.7.7 Disconnection of ~~Generation Units~~ generating units and/or associated loads

- (a) Where, under this Code or the relevant ~~Access Agreement~~ connection agreement the ~~Power System Controller~~ Network Operator has the authority or responsibility to *disconnect* either a ~~Generation Unit~~ generating unit or its *associated load*, then it may do so (~~either directly or through any agent~~) as described in clause ~~8.8~~.
- (b) The relevant *User* and *associated load* shall provide all reasonable assistance to the *Network Operator* for the purpose of such *disconnection*.

#### 4.4.34.7.8 Emergency black start-up facilities

*Generator Users* shall ensure they have sufficient *facilities* available and operable for their own black start-up requirements.

##### ~~4.7.6 — Black system procedures~~

- ~~(a) The Power System Controller shall develop system black procedures and set these procedures out in the System Control Technical Code.~~
- ~~(b) A Generator User shall develop the draft black system procedures for each of its power stations in accordance with the requirements of the System Control Technical Code.~~
- ~~(c) The Power System Controller may request amendments to a User's draft black system procedures or any proposed changes as the Power System Controller reasonably considers necessary by notice in writing to the User, where use is to be made of the network.~~
- ~~(d) If the Power System Controller and a User are unable to agree on the amendments, the matter may be dealt with under the dispute resolution process described in clause 1.6.~~

#### 4.7.9 [Deleted]

#### 4.4.44.7.10 Black system start-up

- ~~(a) The Power System Controller shall advise a User if, in the Power System Controller's reasonable opinion, there is a black system condition which is affecting, or which may affect, that User.~~
- ~~(b) If a User is providing black start-up facilities under an ancillary services agreement with another User, then the local black system procedures for that User shall be consistent with this Code and their Access Agreement.~~
- ~~(c) The Power System Controller may by notice in writing to the relevant User require such amendments to the local black system procedures for a User which, in its reasonable opinion, are needed for consistency with:
  - (1) — actual power system requirements; or~~

~~(2) — if the User is providing black start-up facilities to another User under an ancillary services connection agreement, the relevant Access Agreement.~~

~~(d) If the Power System Controller advises a User of a black system condition, and/or if the terms of the relevant local black system procedures require the~~

~~User to take action, then the User shall comply with the agreed requirements of the local black system procedures.~~

- ~~(e) If there is a black system condition, then a User/Customer shall comply with the Power System Controller's instructions with respect to the timing and magnitude of load restoration, as well as subsequent load movements or disconnections.~~

#### ~~4.7.7— Review of operating incidents~~

- ~~(a) The Power System Controller shall conduct reviews of significant operating incidents or deviations from normal operating conditions in order to assess the adequacy of the provision and response of facilities or services, and the appropriateness of actions taken to restore or maintain power system security.~~
- ~~(b) For all cases where the Power System Controller has been responsible for the disconnection of a User, the Power System Controller shall provide a report of the review carried out to the User advising of the circumstances requiring that action.~~
- ~~(c) A User shall co-operate in any such review conducted by the Power System Controller (including making available relevant records and information).~~
- ~~(d) A User shall provide to the Power System Controller such information relating to the performance of its equipment during and after particular power system incidents or operating condition deviations as the Power System Controller reasonably requires for the purposes of analysing or reporting on those power system incidents or operating condition deviations.~~
- ~~(e) The Power System Controller shall provide to a User such information or reports relating to the performance of that User's equipment during power system incidents or operating condition deviations as that User reasonably requests and in relation to which the Power System Controller is required to conduct a review under this clause.~~

### ~~1.8 — Power system security support~~

#### ~~4.8.1 — Remote control and monitoring devices~~

- ~~(a) All remote control, operational metering and monitoring devices and local circuits as described in clause 3, shall be installed and maintained by a User in accordance with the standards and protocols determined and advised by the Power System Controller (for use in the Power System Controller's control centre) for each:~~
- ~~(1) — Generation Unit and associated load connected to the network;~~
  - ~~(2) — zone substation connected to the network; and~~
  - ~~(3) — ancillary service provided by that User.~~
- ~~(b) The provider of any ancillary services shall arrange the installation and maintenance of all remote control equipment and remote monitoring~~

~~equipment in accordance with the standards and protocols determined by the Power System Controller for use in the Power System Controller's control centre.~~

- ~~(c) The controls and monitoring devices shall include the provision for indication of active power and reactive power output, and to signal the status and any associated alarm condition relevant to achieving adequate protection control and indication of the network, and the User's plant active and reactive output consumption.~~

#### ~~4.8.2 — Operational control and indication communication facilities~~

~~In accordance with clauses 3.3.3.1, 3.3.3.2 and 3.3.3.3, as applicable, Each User shall provide and maintain the necessary primary and, where nominated by the Network Operator, back up communications facilities for control, operational metering and indication from the relevant local sites to the appropriate interfacing termination as nominated by the Network Operator.~~

#### ~~4.8.3 — Power system voice/data operational communication facilities~~

- ~~(a) The Power System Controller shall establish:~~
- ~~(1) — procedures for written and oral communications on operational matters; and~~
  - ~~(2) — minimum telecommunications facilities to be provided by Users; in the System Control Technical Code.~~
- ~~(b) Each User shall advise the Power System Controller of each nominated position for the purposes of giving or receiving operational communications in relation to each of its facilities in accordance with the requirements of the System Control Technical Code.~~
- ~~(c) Each User shall provide, for each nominated position, communication systems in accordance with the requirements of the System Control Technical Code.~~
- ~~(d) Each User shall maintain communication systems in good repair and shall investigate faults within 4 hours, or as otherwise agreed with the Power System Controller, of a fault being identified and shall repair or procure the repair of faults promptly.~~
- ~~(e) The Power System Controller shall advise all Users of nominated persons for the purposes of giving or receiving operational communications in accordance with the requirements of the System Control Technical Code.~~

#### ~~4.8.4 — Records of power system operational communication~~

~~The Power System Controller shall establish the procedures for recording power system operational communications in the System Control Technical Code.~~

#### 4.7.11 [Deleted]

#### 4.54.8 Agent communications

- (a) A *User* may appoint an agent (called a “*User Agent*”) to coordinate operations of one or more of its *facilities* on its behalf, but only with the prior written consent of the *Power System Controller*.
- (b) A *User* who has appointed a *User Agent* may replace that *User Agent* but only with the prior written advice to and consent of the *Power System Controller*.
- (c) The *Power System Controller* may only withhold its consent to the appointment of a *User Agent* under clause 4.8.5(4.8)(a), if it reasonably believes that the relevant person is not suitably qualified or experienced to operate the relevant *facility* at the interface with a *network*.
- (d) For the purposes of this *Code* and any applicable *Access Agreementconnection agreement*, acts or omissions of a *User Agent* are deemed to be acts or omissions of the relevant *User*.
- (e) The *Power System Controller* and its *representatives* (including authorised agents) may:
  - (1) rely upon any communications given by a *User Agent* as being given by the relevant *User*; and
  - (2) rely upon any communications given to a *User Agent* as having been given to the relevant *User*.
- (f) The *Power System Controller* is not required to consider whether any instruction has been given to a *User Agent* by the relevant *User* or the terms of those instructions.

#### 4.64.9 Nomenclature standards

The *Network Operator* ~~shall establish and~~ *Users* are to comply with clause 6.14 of the *SCTC in regard to* nomenclature standards ~~for network equipment;~~

## 5 ~~A User shall use the nomenclature standards for network~~ **Testing of plant and equipment**

~~(a) The testing of plant and equipment and apparatus as agreed with is required before connection to the Network Operator or failing agreement, as determined by the Network Operator.~~

~~(b) A User shall use reasonable endeavours network and periodically thereafter to ensure that its representatives comply with the nomenclature the network and connections can continue to operate within the parameters of the network performance standards in any operational communications with the Power System Controller.~~

A User shall ensure set out in clause 02 and that name plates on its equipment relevant to operations at any point within the power system conform to the meets the requirements to be connected to the network set out in the nomenclature standards clause 03.

~~(c) A User shall use reasonable endeavours to ensure that nameplates on its equipment relevant to operations within the power system are maintained to ensure easy and accurate identification of equipment.~~



- ~~(d) A User shall ensure that technical drawings and documentation provided to the Network Operator comply with the nomenclature standards.~~
- ~~(e) The Network Operator may, by notice in writing, request a User to change the existing numbering or nomenclature of network equipment and apparatus of the User for purposes of uniformity, and the User shall comply with such request provided that if the existing numbering or nomenclature conforms with the nomenclature standards, the Network Operator shall pay all reasonable costs incurred in complying with the request.~~
- ~~(f) All nomenclature shall be unique and unambiguous.~~

## ~~51~~ **Testing of plant and equipment**

The testing of *plant* and equipment is required before connection to the *network* and periodically thereafter to ensure that the *network* and *connections* can continue to operate within the parameters of the *network* performance standards set out in clause 2 and that equipment meets the requirements to be connected to the *network* set out in clause 3.

### 5.1 Obligations to test plant or equipment

#### 5.1.1 Network Operator obligations

- (a) The *Network Operator* shall arrange, co-ordinate and supervise the conduct of such appropriate tests as may be necessary to ensure that:
- (1) the equipment at new *connections* to the *network* meets the requirements set out in clause ~~3.0.3~~.
  - (2) the *protection* of the *network* is adequate to protect against damage to *power system plant* and equipment. Such tests shall be performed according to the requirements of clause ~~5.2.0.5.2~~.
  - (3) the *power system* capability and performance is adequate to meet forecast operating conditions and power flows, as set out in clause ~~5.5.5.5~~.
  - (4) adequate *reactive power* devices are provided and available to control and maintain *power system voltages* under both *satisfactory operating state* and *contingency event* conditions;
  - (5) adequate devices are installed and available to maintain *power system stability*.
  - (6) *Users* continue to comply with the conditions set out in *Access Agreements* ~~connection agreements~~ and that all *Users'* *connection* equipment meets the requirements to set out in clause 3 and ~~5.4.5.4~~.
  - (7) the testing of *metering* installations is carried out in accordance with ~~clause 10.6~~ *the NT NER*.

#### 5.1.2 Network Users' obligations

- ~~(a)~~ All *network* ~~Network~~ *Users* shall cooperate to permit the testing of their *connection*
- (a) *equipment* as required under clause ~~5.1.1~~ *5.1.1*.
- (b) A *Generator* shall provide evidence that each *Generation Unit* ~~generating unit~~ complies with the technical requirements of clause 3.3 and the relevant *Access Agreement* ~~connection agreement~~ as required by clause ~~5.4~~ *5.4*.

## 5.2 Routine testing of protection equipment

- (a) Subject to clause ~~3.2.3.10~~,3.2.3.10, a *User* shall cooperate with the *Network Operator* to test the operation of equipment forming part of a *protection scheme* relating to a *connection point* at which that *User* is *connected* to a *network* and the *User* shall conduct these tests:
- (1) prior to the *plant* at the relevant *connection point* being placed in service; and
  - (2) at intervals specified in the ~~Access Agreement~~connection agreement or in accordance with an asset management plan agreed between the *Network Operator* and the *User*.
- (b) A *User* shall, on request from the *Network Operator*, demonstrate to the *Network Operator's* satisfaction the correct calibration and operation of the *User's* protective devices.
- (c) Each *User* shall pay the *Network Operator's* reasonable costs and shall bear its own costs of conducting tests under this clause ~~5.205.2~~.

## 5.3 Testing by Users of their own plant requiring changes to agreed operation

- (a) A *User* proposing to conduct a test on equipment related to a *connection point*, which requires a *change* to the operation of that equipment as specified in the ~~Access Agreement~~connection agreement, shall give notice in writing to the *Network Operator* of at least 15 *business days* except in an emergency.
- (b) The notice to be provided under ~~clause 5.3~~clause 5.3(a) is to include:
- (1) the nature of the proposed test;
  - (2) the estimated, start and finish *time* for the proposed test;
  - (3) the identity of the equipment to be tested;
  - (4) the *power system* conditions required for the conduct of the proposed test;
  - (5) details of any potential adverse consequences of the proposed test on the equipment to be tested;
  - (6) details of any potential adverse consequences of the proposed test on the *power system*; and
  - (7) the name of the person responsible for the coordination of the proposed test on behalf of the *Users*.
- (c) The *Network Operator* shall review the proposed test to determine whether the test:
- (1) could adversely affect the normal operation of the *power system*;
  - (2) could cause a threat to *power system security*;

- (3) requires the *power system* to be operated in a particular way which differs from the way in which the *power system* is normally operated; or

- (4) could affect the normal *metering of energy at a connection point*;
- (d) If, in the *Network Operator's* reasonable opinion, a test could threaten public safety, damage or threaten to damage equipment or adversely affect the operation of the *power system*, the *Network Operator* may direct that the proposed test procedure be modified or that the test not be conducted at the *time* proposed.
- (e) The *Network Operator* shall advise any other *User* who will be adversely affected by a proposed test and consider any reasonable requirements of those *Users* when approving the proposed test.
- (f) The *User* who conducts a test under this clause ~~5.3~~ 5.3 shall ensure that the person responsible for the coordination of a test promptly advises *Network Operator* when the test is complete.
- (g) If the *Network Operator* approves a proposed test, the *Network Operator* shall use its reasonable endeavours to ensure that *power system* conditions reasonably required for that test are provided as close as is reasonably practical to the proposed start *time* of the test and continue for the proposed duration of the test.
- (h) Within a reasonable period after any such test has been conducted, the *User* who has conducted a test under this clause ~~5.3~~ 5.3 shall provide the *Network Operator* with a report in relation to that test including test results where appropriate.

#### 5.4 Tests to demonstrate Generator compliance

- (a) Each *User* shall provide evidence to the *Network Operator* that each of its ~~Generation Units~~ *generating units* complies with the technical requirements of ~~clause 3.3.2~~ *clause 3.3* and the relevant ~~Access Agreement~~ *connection agreement*.
- (b) Each *User* shall provide facilities to carry out *power system* tests prior to commercial operation in order to verify acceptable performance of each ~~Generation Unit~~ *generating unit*, and provide information and data necessary for computer model validation. These test requirements are detailed in Attachment 5.
- (c) Other tests, if reasonably necessary, may be specified by the *Network Operator*, and *Users* will be advised accordingly.
- (d) Each *User* shall negotiate in good faith with the *Network Operator* to agree on a compliance monitoring program, including an agreed method, for each of its ~~Generation Units~~ *generating units* to confirm ongoing compliance with the applicable technical requirements of clause ~~3.3.23.3~~ and the relevant ~~Access Agreement~~ *connection agreement*.
- (e) If a performance test or monitoring of in-service performance demonstrates that a ~~Generation Unit~~ *generating unit* is not complying with one or more technical requirements of clause ~~3.3.23.3~~ and the relevant ~~Access Agreement~~ *connection agreement* then the *User* shall:
  - (1) promptly notify the *Network Operator* of that fact; and

- (2) promptly advise the *Network Operator* of the remedial steps it proposes to take and the *timetable* for such remedial work; and
  - (3) diligently undertake such remedial work and report at *monthly* intervals to the *Network Operator* on progress in implementing the remedial action; and
  - (4) conduct further tests or monitoring on completion of the remedial work to confirm compliance with the relevant technical requirement.
- (f) From the *Code commencement date* or from the date of access, whichever is the later, Each *User* shall maintain records and retain them for a minimum of 7 years (from the date of creation of each record) for each of its *Generation Units generating units* and *power stations* setting out details of the results of all technical performance and monitoring conducted under this clause ~~5.4~~ 5.4 and make these records available to *Network Operator* on request.

#### 5.4.1 Tests of ~~Generation Units~~ *generating units* requiring changes to agreed operation

- (a) The *Network Operator* may, at intervals of not less than 12 *months* per *Generation Unit generating unit*, require the testing by a *User* of any *Generation Unit generating unit* connected to the *network* of the *Network Operator* in order to determine analytic parameters for modelling purposes or to assess the performance of the relevant ~~Generation Unit~~ *generating unit*. The *Network Operator* is entitled to witness such tests and the *Network Operator* shall have reasonable grounds for requiring such tests.
- (b) Adequate notice of not less than 15 *business days* shall be given by the *Network Operator* to the *User* before the proposed date of a test under clause ~~5.4.1~~ 5.4.1(a).
- (c) The *Network Operator* shall use its reasonable endeavours to ensure that tests permitted under this clause ~~5.4.1~~ 5.4.1 are to be conducted at a *time* which will minimise the departure from the *commitment* that is due to take place at that *time*.
- (d) If not possible beforehand, a *User* shall conduct a test under this clause ~~5.4.1~~ 5.4.1 at the next scheduled *outage* of the relevant *Generation Unit generating unit* and in any event within 9 *months* of the request.
- (e) A *User* shall provide any reasonable assistance requested by the *Network Operator* in relation to the conduct of tests.
- (f) Tests conducted under this clause ~~5.4.1~~ 5.4.1 shall be conducted in accordance with test procedures agreed between the *Network Operator* and the relevant *User*, *who* shall not unreasonably withhold agreement to the test procedures proposed for this purpose by the *Network Operator*.
- (g) The *Network Operator* shall provide to a *User* such details of the analytic parameters of the model derived from the tests referred to in this clause

5.4.15.4.1 for any of that *User's ~~Generation Units~~generating units* as may reasonably be requested by the *User*.

- (h) Each *User* shall bear its own costs associated with tests conducted under this clause ~~5.4.1~~ 5.4.1 and no compensation is to be payable for financial losses incurred as a result of these tests or associated activities.

## 5.5 **Power system tests**

- (a) Tests conducted for the purpose of either verifying the magnitude of the *power transfer capability* of *networks* or investigating *power system* performance shall be coordinated and approved by the *Network Operator*. The *Network Operator* or a *User* requesting such tests shall have reasonable grounds for requiring such tests.
- (b) The tests described in clause ~~5.5.5~~ 5.5.5(a) may be conducted whenever:
- (1) a new *Generation Unit*~~generating unit~~ or facility of a *Customer*~~customer~~, *User* or a *network* development is commissioned that is calculated or anticipated to substantially alter *power transfer capability* through the *network*;
  - (2) setting *changes* are made to any *governor system* and *excitation control system*, including *power system stabilisers*; or
  - (3) a test is required to verify the performance of the *power system* or to validate computer models.
- (c) The *Network Operator* shall notify all *Users* who could reasonably be expected to be affected by the proposed test at least 15 *business days* before any test under this clause ~~5.5.5~~ 5.5.5 may proceed and to consider any reasonable requirements of those *Users* when approving the proposed test.
- (d) Operational conditions for each test shall be arranged by the *Network Operator* and the test procedures shall be coordinated by an officer nominated by the *Network Operator* who has authority to stop the test or any part of it or vary the procedure within pre-approved guidelines if it considers any of these actions to be reasonably necessary.
- (e) Each *User* shall cooperate with the *Network Operator* when required in planning, preparing for and conducting *network* tests to assess the technical performance of the *networks* and if necessary conduct co-ordinated activities to prepare for *power system* wide testing or individual, on-site tests of the *User's facilities* or *plant*, including *disconnection* of a *Generation Unit*~~generating unit~~.
- (f) The *Network Operator* may direct operation of *Generation Units*~~generating units~~ by *Users* during *power system* tests if this is necessary to achieve operational conditions on the *networks* that are reasonably required to achieve valid test results.
- (g) The *Network Operator* shall plan the timing of tests so that the variation from *dispatch* that would otherwise occur is minimised and the duration of the tests is as short as possible consistent with test requirements and *power system security*.



- (h) Each *User* is to bear its own costs of conducting tests under this clause ~~5.5.5.5~~ and no compensation is to be payable for financial losses incurred as a result of these tests or associated activities.
- (i) If the *Network Operator* has initiated the tests as part of a series of periodic *power system* performance assessment studies, then the costs of the studies will be borne by the *Network Operator*. If the tests demonstrate the need for a *User* to install additional equipment in order to maintain or enhance *power system* performance in accordance with this *Code*, then the *User* will be responsible for the cost of installing the additional equipment.

## 5.6 Compliance with the Network Technical Code

### 5.6.1 Right of inspection and testing

- (a) If the *Network Operator* has reasonable grounds to believe that equipment owned or operated by a *User* may not comply with this *Code* or the ~~Access Agreement~~*connection agreement*, the *Network Operator* may require testing of the relevant equipment by giving notice in writing to the *User*.
- (b) If a notice is given under clause ~~5.6.1~~*5.6.1*(a) the relevant test is to be conducted at a *time* agreed by the *Network Operator*.
- (c) The *User* who receives a notice under clause ~~5.6.1~~*5.6.1*(a) shall co-operate in relation to conducting tests requested under clause ~~5.6.1~~*5.6.1*(a).
- (d) The cost of tests requested under clause ~~5.6.1~~*5.6.1*(a) shall be borne by the *Network Operator*, unless the equipment is determined by the tests not to comply with the relevant ~~Access Agreement~~*connection agreement*, and/or this *Code* in which case all reasonable costs of such tests shall be borne by the owner of that equipment.
- (e) Tests conducted in respect of a *connection point* under this clause ~~5.6.1~~*5.6.1* shall be conducted using test procedures agreed between the relevant *User*, which agreement is not to be unreasonably withheld or delayed.
- (f) Tests under this clause ~~5.6.1~~*5.6.1* shall be conducted only by persons with the relevant skills and experience.
- (g) If the *Network Operator* requests a test under this clause ~~5.6.1~~*5.6.1*, the *Network Operator* may appoint a *representative* to witness a test and the relevant *User* shall permit a *representative* appointed under this clause ~~5.6.1~~*5.6.1*(g) to be present while the test is being conducted.
- (h) Subject to clause ~~5.6.1~~*5.6.1*(i), a *User* who conducts a test shall submit a report to the *Network Operator* within a reasonable period after the completion of the test and the report is to outline relevant details of the tests conducted, including but not limited to the results of those tests.

- (i) If a performance test or monitoring of in-service performance demonstrates that equipment owned or operated by a *User* does not comply with this *Code* or the relevant ~~*Access Agreement*~~*connection agreement* then the *User* shall:
  - (1) promptly notify the *Network Operator* of that fact; and
  - (2) promptly advise the *Network Operator* of the remedial steps it proposes to take and the *timetable* for such remedial work; and
  - (3) diligently undertake such remedial work and report at *monthly* intervals to the *Network Operator* on progress in implementing the remedial action; and
  - (4) conduct further tests or monitoring on completion of the remedial work to confirm compliance with the relevant technical requirement.
- (j) The *Network Operator* may attach test equipment or *monitoring equipment* to *plant* owned by a *User* or require a *User* to attach such test equipment or *monitoring equipment*, subject to the provisions of clause ~~5.7.1~~*5.7.1* regarding entry and inspection.
- (k) In carrying out monitoring under clause ~~5.6.1~~*5.6.1* (j), the *Network Operator* shall not cause the performance of the monitored *plant* to be *constrained* in any way.

## 5.6.2 Generator compliance with the Code

- (a) If the *Network Operator* reasonably believes that a *Generator* is not complying with one or more technical requirements of clause ~~3.3.2~~*3.3* and the relevant ~~*Access Agreement*~~*connection agreement*, the *Network Operator* may instruct the *User* to conduct tests within 25 *business days* to demonstrate that the relevant ~~*Generation Unit*~~*generating unit* complies with those technical requirements.
- (b) If the tests provide evidence that the relevant ~~*Generation Unit*~~*generating unit* continues to comply with the technical requirement(s) *Network Operator* shall reimburse the *User* for the reasonable expenses incurred as a direct result of conducting the tests.
- (c) If the *Network Operator*:
  - (1) is satisfied that a ~~*Generation Unit*~~*generating unit* does not comply with one or more technical requirements; and
  - (2) does not have evidence demonstrating that a ~~*Generation Unit*~~*generating unit* complies with the technical requirements set out in clause ~~3.3~~*3.3*; or
  - (3) holds the reasonable opinion that there is or could be a threat to *power system security*,

the *Network Operator* may direct the relevant *User* to operate the relevant ~~*Generation Unit*~~*generating unit* at a particular *generated* output or in a particular mode until the relevant *User* submits evidence reasonably satisfactory to the *Network Operator* that the ~~*Generation Unit*~~*generating unit* is complying with the relevant technical requirement.

(d) A direction under clause ~~5.6.2~~(5.6.2)(c) shall be recorded by the *Network Operator*.

## 5.7 Inspection of *plant* and equipment

### 5.7.1 Right of entry and inspection

- (a) The *Network Operator* or any of its *representatives* (including authorised agents) may, in accordance with this clause ~~5.7.1~~5.7.1, inspect a *facility* of a *User* and the operation and maintenance of that *facility* in order to:
- (1) assess compliance by the relevant *User* with its operational obligations under this *Code*, or ~~an Access Agreement~~a *connection agreement*, or an *ancillary services agreement*; or
  - (2) investigate any possible past or potential threat to *power system security*; or
  - (3) conduct any periodic familiarisation or training associated with the operational requirements of the *facility*.
- (b) If the *Network Operator* wishes to inspect the *facilities* of a *User* under clause ~~5.7.1~~5.7.1(a), the *Network Operator* shall give that *User* at least 2 *business days'* notice in writing of its intention to carry out an inspection. In the case of an emergency condition affecting the *power system* which the *Network Operator* reasonably considers requires access to the *User's facility*, prior notice is not required, however, the *Network Operator* shall notify the *User* as soon as practical after deciding to enter the *User's facility* of the nature and extent of the *Network Operator's* activities at the *User's facility*.
- (c) A notice given under clause ~~5.7.1~~5.7.1(b) shall include the following information:
- (1) the name of the *representative* who will be conducting the inspection on behalf of the *Network Operator*;
  - (2) subject to clause ~~5.7.1~~5.7.1(h), the *time* when the inspection will commence and the expected *time* when the inspection will conclude; and
  - (3) if associated with clause ~~5.7.1~~5.7.1(a)(1) then the nature of the suspected non-compliance with the *Code* or ~~Access Agreement~~*connection agreement* or *ancillary services agreement*, or if associated with clauses ~~5.7.1~~5.7.1(a)(2) or ~~5.7.1~~5.7.1(a)(3) then the relevant reasons for the inspection.
- (d) The *Network Operator* may not carry out an inspection under clause ~~5.7.1~~5.7.1 within 6 *months* of any previous inspection except for the purpose of verifying the performance of corrective action claimed to have been carried out in respect of a non-conformance observed and documented on the previous inspection or for the purpose of investigating an operating incident in accordance with ~~clause 4.7.11, the~~ *NT NER*.
- (e) At any *time* when the *representative* of the *Network Operator* is in a *Users' facility*, that *representative* shall:
- (1) cause no damage to the *facility*;

- (2) only interfere with the operation of the *facility* to the extent reasonably necessary and approved by the relevant *User* (such approval not to be unreasonably withheld or delayed);
  - (3) observe “permit to test” access to sites and clearance protocols of the operator of the *facility*, provided that these are not used by the *facility* solely to delay the granting of access to site and inspection;
  - (4) observe the requirements of the operator of the *facility* in relation to occupational health and safety and industrial relations matters, which requirements are of general application to all invitees entering on or into the *facility*, provided that these are not used by the *facility* solely to delay the granting of access to site and inspection; and
  - (5) not ask any question other than as reasonably necessary for the purpose of such inspection or give any *direction*, instruction or advice to any person involved in the operation or maintenance of the *facility* other than the operator of the *facility* or unless approved by the operator of the *facility*.
- (f) Any *representative* of the *Network Operator* conducting an inspection under this clause ~~5.7.1-5.7.1~~ shall be appropriately qualified and experienced to perform the relevant inspection. If so requested by the *User*, the *Network Operator* shall procure that a *representative of Network Operator* (other than an employee) gaining access under this *Code* or an ~~Access Agreement~~ *connection agreement* enters into a confidentiality undertaking in favour of the *User* in a form reasonably acceptable to the *User* prior to gaining such access.
- (g) The costs of inspections under this clause ~~5.7.1-5.7.1~~ shall be borne by the *User* if the suspected non-compliance is later proved by tests.
- (h) Any inspection under clause ~~5.7.1~~5.7.1(a) shall not take longer than one *day* unless the *Network Operator* seeks approval from the *User* for an extension of *time* (such approval not to be unreasonably withheld or delayed).
- (i) Any equipment or goods installed or left on land or in premises of a *User* after an inspection conducted under this clause ~~5.7.1-5.7.1~~ do not become the property of the relevant *User* (notwithstanding that they may be annexed or affixed to the relevant land or premises).
- (j) In respect of any equipment or goods left on land or premises of a *User* during or after an inspection, a *User*:
- (1) shall not use any such equipment or goods for a purpose other than as contemplated in this *Code* without the prior written approval of the owner of the equipment or goods;
  - (2) shall allow the owner of any such equipment or goods to remove any such equipment or goods in whole or in part at a *time* agreed with the relevant *User* with such agreement not to be unreasonably withheld or delayed;

- (3) shall not create or cause to be created any mortgage, charge or lien over any such equipment or goods; and
- (4) shall reimburse the owner of any such equipment or goods for reasonable costs and expenses suffered or incurred by the owner due to loss or damage to any such equipment or goods caused by the *User*.

## 6 Control and *protection* settings

### 6.1 Protection of power system equipment

It is important to note that the requirements of this clause 6 are designed to adequately protect the *Network Operator's power system*. The requirements are not necessarily adequate to protect *Users' plant* and equipment.

#### ~~6.1.1~~ Scope

It is important to note that the requirements of this clause 06 are designed to adequately protect the *Network Operator's power system*. The requirements of clause 6.1 are not necessarily adequate to protect *Users' plant* and equipment.

#### 6.1.1 Scope

- (a) The requirements of clause 6.1 apply only to a *User's protection*, which is necessary to maintain *power system security*.
- (b) *Users' protection schemes* shall be located on *Users' equipment*.
- (c) *Protection* installed solely to cover risks associated with a *User's plant* and equipment is at the *User's discretion*.
- (d) The extent of a *User's plant* and equipment that will need to conform to the requirements of clause ~~6.1~~ 6.1 will vary from installation to installation.
- (e) The *Network Operator* will assess each *User's installation* individually. *Users will be advised accordingly.*  
~~will be advised accordingly.~~

#### ~~6.1.1~~ 6.1.2 Power system fault levels

- (a) The *Network Operator* shall determine the fault levels at all *busbars* of the ~~*Network Operator's network* as described in clause 6.1.2(b);~~  
*Network Operator's network* as described in clause 6.1.2(b);
- (b) The *Network Operator* shall ensure that there is information available about the *network* that will allow the determination of fault levels for normal operation of the *power system*. The *Network Operator* will make available on request the *credible contingency events* which the *Network Operator* considers may affect the configuration of the *power system* so that the *Network Operator* and *Users* can identify their *busbars* which could potentially be exposed to a fault level which exceeds the fault *current ratings* of the circuit breakers and other equipment associated with that *busbar*.

### **6.1.26.1.3 Power system protection co-ordination**

The *Network Operator* shall use its reasonable endeavours to co-ordinate the *protection* settings for equipment *connected* to the *network*. *Users* with *protection systems* that impact *power system security* and *reliability* shall ensure their settings co-ordinate with the *Network Operator's protection*. *Such Users* may not adjust settings without the *Network Operator's* approval. *Specific requirements are described in clauses 6.1.6.4 clauses 6.1.6.4 and 11.2.2.11.2.2.*

### **6.1.36.1.4 Short-term thermal ratings of the power system**

- (a) The *Network Operator* may act so as to use, or require or recommend actions which use the full extent of the thermal ratings of *network* elements to maintain *power system security*, including the short-term ratings (being *time* dependent ratings), as defined by the *Network Operator* from *time* to *time*.

- (b) The *Power System Controller* shall use its reasonable endeavours not to exceed the *network* element ratings and not to require or recommend action that causes those ratings to be exceeded.

#### **6.1.46.1.5 Availability of protection**

- (a) All elements of *protection schemes*, including *backup protection* and associated intertripping, shall be maintained so as to be available for service at all *times*.
- (b) For maintenance or repair purposes, one *protection scheme* forming part of a *protection system* can be taken out of service for period of up to 24 hours every 6 *months*.
- (c) At the discretion of the *Network Controller*, longer periods of unavailability may require the associated *primary plant* to be taken out of service in accordance with clause ~~6.1.6-6.1.6~~.
- ~~(a)~~ Except in an emergency, a *User* shall notify the *Network Operator* at least 5
- (d) *business days* prior to taking a *protection scheme* out of service.

#### **6.1.56.1.6 Partial outage of power protection systems**

- (a) Where there is an *outage* of one *protection* of a *network* element, the *Power System Controller* shall determine, the most appropriate action. Depending on the circumstances the determination may be:
  - (1) to leave the *network* element in service for a limited duration;
  - (2) to take the *network* element out of service immediately;
  - (3) to install or direct installation of a temporary *protection*;
  - (4) to accept a degraded performance from the *protection*, with or without additional operational measures or temporary *protection* measures to minimise *power system* impact; or
  - (5) to operate the *network* element at a lower capacity.
- (b) If there is an *outage* of both *protection schemes* on a *network* element and the *Power System Controller* determines this to be an unacceptable risk to *power system security*, the *Power System Controller* shall take the *network* element out of service as soon as possible and advise any affected *User* immediately this action is undertaken.
- (c) Any affected *User* shall accept a determination made by the *Network Operator* under this clause ~~6.1.6-6.1.6~~.

##### 6.1.516.1.6.1 Sensitivity of protection

- (a) All *protection schemes* shall have sufficient *sensitivity* to detect and correctly clear all *primary plant* faults within their intended normal operating zones, under both normal and *minimum system conditions*.
- (b) *Protection schemes* shall discriminate with the *Network Operator's protection*.



- (c) Under abnormal *plant* conditions, all primary system faults shall be detected and cleared by at least one *protection scheme* on the *User's* equipment. *Remote backup protection* or *standby protection* may be used for this purpose.
- (d) The *protection* will be considered to have sufficient *sensitivity* if it will detect and correctly clear a fault when there is half the fault current that will flow for the above conditions.
- (e) In rural areas where the earth return impedance is high, sensitive earth fault *protection* may also be required, in addition to the above backup and primary *protection*.

#### 6.1.5.26.1.6.2 Clearance of *small zone faults*

*Small zone faults* shall be detected and cleared by *backup protection* as specified in ~~clause 3.2.3.6~~ clause 3.2.3.6.

#### 6.1.5.26.1.6.3 Clearance of faults under circuit breaker fail conditions

Failure of a circuit breaker, due to either a mechanical or electrical fault, to clear a fault shall, when reasonably required by the *Network Operator*, be detected and the primary fault current shall be cleared by *backup protection* as specified in the clause ~~3.2.3.6~~ 3.2.3.6.

#### 6.1.5.46.1.6.4 Details of proposed *Users' protection settings*

Unless agreed otherwise, *Users* shall provide the *Network Operator* with full details of proposed *protection settings* and setting calculations on all *plant* that may impact on the *Network Operator's power system* a minimum of 65 *business days* prior to *energisation* of the protected *primary plant*. Refer to clause ~~7.1.3~~ 7.1.3.

#### 6.1.5.56.1.6.5 Coordination of *protection settings*

- (a) The *User* shall ensure that all their *protection settings* coordinate with existing *Network Operator protection settings*. Where this is not possible, the *User* will be responsible for the cost of revising *Network Operator settings* and upgrading *Network Operator* or other *Users' equipment*, where required.
- (b) Generally, *Network Operator protection* which discriminates on the basis of *time* employs devices with standard inverse characteristics to BS-EN-60255-6:1995 with a 3 second curve at 10 times current and *time* multiplier of 1.0. Note that this is the specification of the characteristic rather than the device setting. Distance relay Zone 2 *time* is generally set to 400 msec and Zone 3 *time* to 1000 msec.
- (c) Specific details of *Network Operator protection* are available on request.

## 6.2 Power system stability co-ordination

- ~~(a)~~ The *Network Operator* shall use its reasonable endeavours to ensure that all necessary calculations associated with the stable operation of the *power system* as described in clause ~~2.6~~ 2.6 and for the determination of settings of

- |
- (a) .equipment used to maintain that stability are carried out and to co-ordinate these calculations and determinations.
  - (b) The *Network Operator* shall facilitate establishment of the parameters and endorse the installation of *power system* devices that are approved by the *Network Operator* to be necessary to assist the stable operation of the *power system*.

## 7 Commissioning and testing procedures

### 7.1 Commissioning

#### 7.1.1 Requirement to inspect and test equipment

- (a) A *User* shall ensure that any of its new or replacement equipment is inspected and tested to demonstrate that it complies with relevant *Australian Standards*, relevant international standards, this *Code* and any relevant *Access Agreement*~~connection agreement~~ prior to or within an agreed *time* after being connected to a *network*, and the *Network Operator* is entitled to witness such inspections and tests.
- (b) The *User* shall produce test certificates on request by the *Network Operator* showing that the equipment has passed the tests and complies with the standards set out in clause ~~7.1.1~~(7.1.1)(a) before *connection* to the *power system*, or within an agreed *time* thereafter.

#### 7.1.2 Co-ordination during commissioning

A *User* seeking to *connect* to a *network* shall cooperate with the *Network Operator* to develop procedures to ensure that the commissioning of the *connection* and *connected facility* is carried out in a manner that:

- (a) Does not adversely affect other *Users* or affect *power system security* or *quality of supply of the power system*; and  
~~quality of supply of the power system; and~~
- (b) Minimises the threat of damage to any other *Users'* equipment.

#### 7.1.3 Control and protection settings for equipment

- (a) Not less than 65 *business days* prior to the proposed commencement of commissioning of any new or replacement equipment that could reasonably be expected to alter performance of the *power system*, the *User* shall submit to the *Network Operator* sufficient design information including proposed parameter settings to allow critical assessment including analytical modelling of the effect of the new or replacement equipment on the performance of the *power system*.
- (b) The *Network Operator* shall:
  - (1) consult with other *Users* as appropriate; and
  - (2) within 20 *business days* of receipt of the design information under clause ~~7.1.3~~(7.1.3)(a), notify the *User* of any comments on the proposed parameter settings for the new or replacement equipment.
- (c) If the *Network Operator's* comments include alternative parameter settings for the new or replacement equipment, then the *User* shall notify the *Network Operator*

within 20 *business days* that it either accepts or disagrees with the alternative parameter settings suggested by the *Network Operator*.

- (d) The *Network Operator* and the *User* shall negotiate parameter settings that are acceptable to them both.
- (e) The *User* and the *Network Operator* shall co-operate with each other to ensure that adequate grading of *protection* is achieved so that faults within the *User's facility* are cleared without adverse effects on the *power system*.
- (f) The *User* shall pay the *Network Operator's* reasonable costs associated with the assessment of the parameter settings under this clause ~~7.1.3~~7.1.3.

#### 7.1.4 Commissioning program

- (a) Not less than 65 *business days* prior to the proposed commencement of commissioning by a *User* of any new or replacement equipment that could reasonably be expected to alter performance of the *power system*, the *User* shall advise the *Network Operator* in writing of the commissioning program including test procedures and proposed test equipment to be used in the commissioning.
- (b) The *Network Operator* shall, within 20 *business days* of receipt of such advice under clause ~~7.1.4~~7.1.4(a), notify the *User* either that it:
  - (1) agrees with the proposed commissioning program and test procedures; or
  - (2) requires *changes* in the interest of maintaining *power system security*, safety or *quality of supply*.
- (c) If the *Network Operator* requires *changes*, then the parties shall co-operate to reach agreement and finalise the commissioning program within a reasonable period.
- (d) A *User* shall not commence the commissioning until the commissioning program has been finalised and the *Network Operator* shall not unreasonably delay finalising a commissioning program.
- (e) The *User* shall pay the *Network Operator's* reasonable costs associated with the assessment of the commissioning program under this clause ~~7.1.4~~7.1.4.

#### 7.1.5 Commissioning tests

- (a) The *Network Operator* has the right to witness commissioning tests relating to new or replacement equipment that could reasonably be expected to alter performance of the *power system* or the accurate *metering of energy*, including SCADA equipment.
- (b) Prior to *connection* to the *Network Operator's power system*, the *User* shall have provided to the *Network Operator* a signed written statement to certify that the equipment to be *connected* has been installed in accordance with:
  - (1) this Code;
  - (2) the relevant ~~Access Agreement~~connection agreement;

- (3) all relevant standards;
  - (4) all statutory requirements; and
  - (5) *good electricity industry practice*.
- (c) The statement shall have been certified by a professional engineer, as approved by the *Network Operator*.
- (d) The *Network Operator* shall, within a reasonable period of receiving advice of commissioning tests, notify the *User* whose new or replacement equipment is to be tested under this clause ~~7.1.5-7.1.5~~ whether or not it:
- (1) wishes to witness the commissioning tests; and
  - (2) agrees with the proposed commissioning times.
- (e) A *User* whose new or replacement equipment is tested under this clause ~~7.1.5-7.1.5~~ shall submit to the *Network Operator* the commissioning test results demonstrating that a new or replacement item of equipment complies with this *Code* or the relevant ~~Access Agreement~~*connection agreement* or both to the satisfaction of the *Network Operator*.
- (f) If the commissioning tests conducted in relation to a new or replacement item of equipment demonstrates non-compliance with one or more requirements of this *Code* or the relevant ~~Access Agreement~~*connection agreement* then the *User* whose new or replacement equipment was tested under this ~~clause 7.1.5~~*clause 7.1.5* shall promptly meet with the *Network Operator* to agree on a process aimed at achievement of compliance of the relevant item with this *Code*.
- (g) The *Network Operator* may direct that the commissioning and subsequent *connection* of the *User's* equipment should not proceed if the relevant equipment does not meet the technical requirements specified in ~~clause 7.1.1~~  
~~clause 7.1.1~~.
- (h) All commissioning and testing of *User* owned equipment shall be carried out by personnel experienced in the commissioning of *power system primary plant* and *secondary plant*.
- (i) The *User* shall pay the *Network Operator's* reasonable costs associated with the witnessing of commissioning tests under this clause ~~7.1.5-7.1.5~~.

#### 7.1.5.1 Commissioning of protection

- (a) The *Network Operator* reserves the right to witness the commissioning tests on any of the *User's* *protection* that it deems to be important or critical for the *reliable* operation and integrity of the *Network Operator power system*.
- (b) The *User* shall pay *Network Operator's* reasonable costs associated with the witnessing of the commissioning tests.
- (c) All commissioning and testing of *User* owned *protection* shall be carried out by personnel suitably qualified and experienced in the commissioning, testing and maintenance of *primary plant* and *secondary plant* and equipment.

## 8 Disconnection and reconnection of plant and equipment

### 8.1.1 Voluntary disconnection

- (a) Unless agreed otherwise and specified in ~~an Access Agreement~~ a connection agreement, a User shall give to the Network Operator notice in writing of its intention to permanently *disconnect a facility* from a *connection point*.
- (b) A User is entitled, subject to the terms of the relevant ~~Access Agreement~~ connection agreement, to require voluntary permanent *disconnection* of its equipment from the *power system* in which case appropriate operating procedures necessary to ensure that the *disconnection* will not threaten *power system security* shall be implemented in accordance with clause ~~8.1.2~~ 8.1.2.
- ~~(c) The User shall pay all costs directly attributable to the voluntary disconnection~~
- (c) and decommissioning.

### 8.1.2 Decommissioning procedures

- (a) In the event that a User's facility is to be permanently *disconnected* from the *power system*, whether in accordance with clause ~~8.1.1~~ 8.1.1 or otherwise, the Network Operator and the User shall, prior to such *disconnection* occurring, follow agreed procedures for *disconnection*.
- (b) The Network Operator shall notify other Users if it believes, in its reasonable opinion, the terms and conditions of such ~~an Access Agreement~~ a connection agreement will be affected by procedures for *disconnection* or proposed procedures agreed with any other Users. The parties shall negotiate any amendments to the procedures for *disconnection* or the ~~Access Agreement~~ connection agreement that may be required.
- (c) Any *disconnection* procedures agreed to or determined under clause ~~8.1.2~~ 8.1.2 (a) shall be followed by the Network Operator and all Users.

### 8.1.3 Involuntary disconnection (refer also to clause ~~4.7~~ 4.7)

- (a) The Network Operator may *disconnect* a User's facilities from a *network*:
  - (1) during an emergency in accordance with clause ~~8.1.5~~ 8.1.5;
  - (2) in accordance with relevant laws; or
  - (3) in accordance with the provisions of the User's ~~Access Agreement~~ connection agreement.
- (b) In all cases of *disconnection* by the Network Operator during an emergency in accordance with clause ~~8.1.5~~ 8.1.5, the Network Operator is required to undertake a review ~~under clause 4.7.11~~ and the Network Operator shall then provide a report to the User advising of the circumstances requiring such action.

#### 8.1.4 Disconnection due to breach of ~~an Access Agreement~~ a connection agreement

~~(b)~~ Subject to the relevant provisions the *Network Operator* may *disconnect* a *User's facilities* from a *network* if in the *Network Operator's* reasonable opinion, the *User* has breached a term of the ~~Access Agreement~~ connection agreement and such breach poses a threat to *power system security*. In such circumstances the



- (a) *Network Operator* will not be liable in any way for any loss or damage suffered or incurred by the *User* by reason of the *disconnection* and the *Network Operator* will not be obliged for the duration of the *disconnection* to fulfil any agreement to convey electricity to or from the *User's facility*.
- (b) A *User* shall not bring proceedings against the *Network Operator* to seek to recover any amount for any loss or damage described in clause ~~8.1.4~~8.1.4(a).
- (c) A *User* whose *facilities* have been *disconnected* under this clause ~~8.1.4~~8.1.4 shall pay charges in accordance with the *Network Pricing and Charges Schedule* as if any *disconnection* had not occurred.

### 8.1.5 Disconnection during an emergency

Where the *Network Operator* may *disconnect* a *User's facilities* during an emergency under this *Code* or otherwise, then the *Network Operator* may:

- (a) Request the relevant *User* to reduce the *power transfer* at the proposed point of *disconnection* to zero in an orderly manner and then *disconnect* the *User's facility* by automatic or manual means; or
- (b) Immediately *disconnect* the *User's facilities* by automatic or manual means where, in the *Network Operator's* reasonable opinion, it is not appropriate to follow the procedure set out in clause ~~8.1.5~~8.1.5(a) because action is urgently required as a result of a threat to safety of persons, hazard to equipment or a threat to *power system security*.

### 8.1.6 Obligation to reconnect

The *Network Operator* shall *reconnect* a *User's facilities* to a *network* at a reasonable cost to the *User* as soon as practical if:

- (a) *Disconnection* of the *User* during an emergency has taken place in accordance with clause ~~8.1.5~~8.1.5.
- (b) A breach of this *Code* or ~~Access Agreement~~connection agreement giving rise to *disconnection* has been remedied; or
- (c) Where the breach is not capable of remedy, compensation has been agreed and paid by the *User* to the affected parties or, failing agreement, the amount of compensation payable has been determined in accordance with the dispute resolution process described in clause ~~4.6~~1.6 and that amount has been paid; or
- (d) Where the breach is not capable of remedy and the amount of compensation has not been agreed or determined, assurances for the payment of reasonable compensation have been given to the satisfaction of the *Network Operator* and the parties affected; or
- (e) The *User* has taken all necessary steps to prevent the re-occurrence of the breach and has delivered binding undertakings to the *Network Operator* that the breach will not reoccur.

## 9 Operation of *Generators connected to the network*

### 9.1 *Power system security* related market operations

#### 9.1.1 Dispatch related limitations

A *User* shall not, unless in the *User's* reasonable opinion public safety would otherwise be threatened or there would be a material risk of damaging equipment or the environment:

- (a) Dispatch any energy from a ~~Generation Unit~~*generating unit* except:
  - (1) in accordance with the procedures specified in this Code and its Technical Requirements for *connection*; or
  - (2) in accordance with an instruction from the *Power System Controller*; or
  - ~~(1)~~ as a consequence of operation of the ~~Generation Unit's~~*generating unit's* automatic load
  - (3) following scheme approved by the *Network Operator*; or
  - (4) in accordance with a procedure agreed with the *Network Operator*; or
  - (5) in *connection* with a test conducted in accordance with the requirements of this Code or a procedure agreed with by the *Network Operator*.
- (b) Adjust the *transformer tap position* or *excitation control system voltage* set-point of a scheduled ~~Generation Unit~~*generating unit* except:
  - ~~(2)~~ in accordance with an instruction from or by agreement with the
  - (1) *Network Operator*; or
  - (2) in response to remote control signals given by the *Network Operator* or its agent; or
  - (3) if, in the scheduled *User's* reasonable opinion, the adjustment is urgently required to prevent material damage to the *User's plant* or associated equipment, or in the interests of safety; or
  - (4) in *connection* with a test agreed with the *Network Operator* and conducted in accordance with this Code or procedures agreed with the *Network Operator*.
- (c) Energise a *connection point* in relation to a *User's* ~~Generator~~*generating unit* without prior approval from the *Network Operator*. This approval shall be obtained immediately prior to *energisation*;
- (d) Synchronise a scheduled ~~Generation Unit~~*generating unit* to, or de-synchronise a scheduled ~~Generation Unit~~*generating unit* from, the *power system* without prior approval from the *Power System Controller* except *de-synchronisation* as a consequence of the operation of automatic *protection* equipment or where such action is urgently required to prevent material damage to *plant* or equipment or in the interests of safety;

(e) Change the frequency response mode of a scheduled ~~Generation Unit~~generating unit without the prior approval of the Network Operator; or

- ~~(b)~~ Remove from service or interfere with the operation of any power system
- (f) stabilising equipment installed on that ~~Generation Unit~~generating unit.

See also clauses 3.3 and 4.2 of Version 4.0 of the System Control Technical Code.

#### ~~9.1.2~~ Commitment of Generation Units

~~In relation to any User's Generation Unit, the User shall confirm with the Power System Controller, the expected synchronism time at least one hour before the expected actual synchronising time, and update this advice 5 minutes before synchronising unless otherwise agreed with the Power System Controller. The Power System Controller may require further notification immediately before synchronisation.~~

#### ~~9.1.3~~ De-commitment, or output reduction, by Users requiring standby power

- (a) ~~Any User requiring standby power from a Generator or the Network Operator shall notify the Power System Controller well in advance. To do this a User will have to both apply for it and include it in the outage and production plans they submit to the Power System Controller.~~
- (b) ~~A User shall confirm with the Power System Controller the expected de-synchronising time at least one hour before the expected actual de-synchronising time, and update this advice 5 minutes before de-synchronising unless otherwise agreed with the Power System Controller. The Power System Controller may require further notification immediately before de-synchronisation.~~
- (c) ~~Information to be confirmed with the Power System Controller to de-commit a User's Generation Unit if there is to be no automatic and coincident reduction in the User's associated load shall include:~~
- ~~(1) the time to commence decreasing the output of the Generation Unit;~~
  - ~~(2) the ramp rate to decrease the output of the Generation Unit;~~
  - ~~(3) the time to de-synchronise the Generation Unit; and~~
  - ~~(4) the output from which the Generation Unit is to be de-synchronised~~
- (d) ~~Any User not requiring standby power that wishes to take a Generator out of service shall first reduce the associated load demand by an amount equal to the Generator output to be reduced. Once the demand has been reduced, the Generator's load may be reduced. Clearance shall be obtained from the Power System Controller before commencing this exercise.~~

### 9.1.2 [Deleted]

### 9.1.3 [Deleted]

## **9.2 Users' plant changes**

A *User* shall, without delay, notify the *Power System Controller* of any event which has *changed* or is likely to *change* the operational availability or *load* following capability of any of its ~~*Generation Units*~~*generating units*, whether the relevant ~~*Generation Unit*~~*generating unit* is *synchronised* or not, as soon as the *User* becomes aware of the event.

### 9.3 Operation, maintenance and extension planning

Operation, maintenance and *extension* planning and co-ordination shall be performed in accordance with this *Code* and any applicable ~~*Access Agreement*~~*connection agreement*.

#### ~~1.9~~ **Generating limits**

~~Limits to the VAr *Generation* and absorption capability of *Generation Facilities* and reactive compensation *plant* such as *static var compensators* shall not be exceeded.~~

## **2 — Metering requirements**

~~This clause 10 applies to all Users at any revenue metering point through which energy is transferred to or energy is taken from the Network Operator's electricity network.~~

### **2.1 — Purpose of metering clause**

- ~~(a) The purpose of clause 10 is to set out the rights and obligations of Users and the Network Operator.~~
- ~~(b) Clause 10 sets out provisions relating to:
  - ~~(1) revenue metering installations used for the measurement of active energy and reactive energy, imported and/or exported;~~
  - ~~(2) check metering installations;~~
  - ~~(3) the collection of revenue metering data;~~
  - ~~(4) the provision, installation and maintenance of equipment;~~
  - ~~(5) the accuracy of revenue metering equipment;~~
  - ~~(6) testing requirements;~~
  - ~~(7) the security and rights of access to revenue metering data and equipment; and~~
  - ~~(8) the provision of revenue metering data.~~~~

### **2.2 — Metering principles**

~~The key metering principles are as follows:~~

- ~~(a) Each connection point shall have a revenue metering installation.~~
- ~~(b) The type of revenue metering installation at each revenue metering point is to be determined by the Network Operator in accordance with the annual amount of energy passing through that revenue metering point.~~
- ~~(c) The Network Operator will have responsibility for the provision and installation of revenue metering unless the User elects to provide and install the revenue metering, other than the revenue meters, which will be provided and installed by the Network Operator.~~
- ~~(d) The Network Operator will install the revenue meters or the revenue metering, and will commission and maintain the revenue metering.~~
- ~~(e) The Network Operator may offer to install a check meter, or check meters, or check metering, and commission and maintain check metering on behalf of the User.~~
- ~~(f) The Network Operator will own the revenue metering installation and the User may be required to make a non-refundable contribution to the cost of the installation.~~

- ~~(g) All costs associated with the auditing and maintenance of a revenue metering installation will be borne by the User.~~
- ~~(h) The Network Operator shall ensure that the accuracy of each component of a revenue metering installation complies with its accuracy class.~~
- ~~(i) Energy data is to be based on units of watt hours active energy and var hours reactive energy.~~
- ~~(j) The Network Operator will make revenue metering data available to Each User, subject to confidentiality requirements.~~
- ~~(k) The revenue meters used will make provision for signals comprising energy usage information to be available via volt free relay contacts at the revenue metering location.~~
- ~~(l) The specifications for the revenue metering voltage and current transformers will make provision for secondary voltages and currents to allow the User to readily install check metering, if required by the User.~~
- ~~(m) Historical revenue metering data is to be retained for a minimum of 7 years.~~
- ~~(n) The Network Operator will audit revenue metering when requested.~~

## **2.3 — Responsibility for metering installation**

### **10.3.1 Responsibility of the Network Operator**

- ~~(a) No later than 20 business days after receiving a request for the provision of a revenue metering installation, or a revenue metering installation and a check metering installation from a prospective User, the Network Operator shall provide a quotation and any conditions on which the offer is made~~
- ~~(b) The Network Operator will advise the User of its right to provide and install certain revenue metering components in accordance with Attachment 4 and the Network Operator's Metering Manuals, Underground Manual and Overhead Line Manual.~~
- ~~(c) If the User accepts the offer, the Network Operator has the responsibility for the provision, installation, commissioning and maintenance of the revenue metering equipment in accordance with Attachment 4 and the Network Operator's metering manuals, Underground Manual and Overhead Line Manual.~~

### **10.3.2 User elects to provide and install certain metering components**

- ~~(a) If the User does not accept the offer made by the Network Operator to provide a revenue metering installation, the User will be responsible for the provision and installation of the revenue metering, except for the revenue meters in accordance with Attachment 4 and the Network Operator's metering manuals and the check metering, if required by the User.~~



- ~~(b) The Network Operator will provide and install the revenue meters, commission the installation and provide ongoing maintenance of the revenue metering installation in accordance with Attachment 4 and the Network Operator's metering manuals.~~

#### ~~10.3.2 Other responsibilities~~

- ~~(a) The Network Operator shall ensure that the revenue metering installation is provided, installed and maintained in accordance with Attachment 4 and the Network Operator's metering manuals.~~
- ~~(b) The User, if providing and installing revenue metering equipment, shall ensure that the equipment complies with Attachment 4 and the Network Operator's metering manuals.~~
- ~~(c) Prior to installation, the equipment that is involved in measurement of energy, other than the check meters shall be submitted to the Network Operator for testing for compliance with the Network Operator's metering manuals.~~

## **2.4 — Metering installation arrangements**

### ~~10.4.1 Metering installation components~~

- ~~(a) A revenue metering installation shall comply with the requirements of the National Standards (Weight & Measures) Act in regard to being a measuring device that is used for trade or legal purposes.~~
- ~~(b) A revenue metering installation shall:~~
- ~~(1) contain a measuring device for active and reactive energy and a visible display of all revenue metering data as per Australian Standard AS1284;~~
  - ~~(2) be accurate in accordance with Attachment 4;~~
  - ~~(3) have electronic data transfer facilities;~~
  - ~~(4) be secure in accordance with the Network Operator's metering manuals;~~
  - ~~(5) have electronic data recording facilities for active and reactive energy flows;~~
  - ~~(6) be capable of separately registering and recording energy import and export where bi-directional energy flows occur;~~
  - ~~(7) be capable of providing revenue metering data to a communication system; and~~
  - ~~(8) include a communication system for two way communications with the Network Operator.~~
- ~~(c) A revenue metering installation will consist of combinations of, but is not limited to, the following:~~
- ~~(1) current transformer;~~
  - ~~(2) voltage transformers;~~

- ~~(3) secure and protected wiring;~~
  - ~~(4) revenue meter panels on which the revenue meters and communication equipment are mounted;~~
  - ~~(5) communication equipment such as modem, Public Switched Telephone Network connection, isolation, radio transmitter and receiver, data link, or power line carrier equipment;~~
  - ~~(6) test links and fusing;~~
  - ~~(7) energy and status signals;~~
  - ~~(8) summation equipment;~~
  - ~~(9) revenue metering enclosure;~~
  - ~~(10) marshalling boxes; and~~
  - ~~(11) revenue metering unit.~~
- ~~(d) The revenue metering installation is exclusively for revenue metering other than the provision of energy and status signals which may be provided to the User for other purposes.~~

#### ~~10.4.2 Metering for connection of Small Inverter Energy Systems~~

- ~~(a) A User with a Small Inverter Energy System shall make provision for both an import and export meter.~~
- ~~(b) Should an additional meter be required for the export power meter, the User may need to install an additional meter box or rearrange the existing meter box to accommodate a second meter.~~

#### ~~10.4.3 Use of meters~~

- ~~(a) Revenue metering data will be used by the Network Operator as the primary source of billing data.~~
- ~~(b) Where appropriate check metering data is available, it will be used by the Network Operator for:
  - ~~(1) validation;~~
  - ~~(2) substitution; and~~
  - ~~(3) account estimation~~of revenue metering data as required by clause 10.9.4.~~

#### ~~10.4.4 Metering type and accuracy~~

- ~~(a) The accuracy for a revenue metering installation and the requirements for a revenue metering installation that shall be installed at each revenue metering point shall be in accordance with Attachment 4 and the Network Operator's metering manuals.~~

~~(b) A check metering installation is not required, but if provided by a User it may use the voltages and currents provided by the revenue metering voltage transformers and current transformers. The check meter or check meters will be of the same class as the revenue meters.~~

~~(c) If the User elects to provide separate current transformers and voltage transformers they shall comply with clause 10.3.3.~~

#### **10.4.5** Data collection system

~~(a) The Network Operator shall ensure that an appropriate communication system is installed to each revenue metering installation.~~

~~(b) The Network Operator shall establish processes for the collection of revenue metering data from each revenue metering installation for storage in a revenue metering data base in accordance with the Network Operator's metering manuals.~~

~~(c) The Network Operator may obtain revenue metering data directly from a revenue metering installation.~~

#### **10.4.6** Payment for metering

~~(a) The User is responsible for payment of all costs associated with the provision, installation, commissioning, maintenance, routine testing and inspection, routine audits, downloading of revenue metering data, processing and account resolution for a revenue metering installation.~~

~~(b) The cost of requisition testing and audits shall be borne by the party requesting the test or audit, except where the revenue metering installation is shown not to comply with this clause, in which case the Network Operator shall bear the cost.~~

### **2.5** Register of metering information

~~(a) As part of the revenue metering database, the Network Operator shall maintain a revenue metering register of all Users' revenue metering installations and check metering installations that provide tariff data.~~

~~(b) The revenue metering register for a particular User's revenue metering installation shall be made available to the User on request.~~

#### **10.5.1** Meter register discrepancy

~~(a) If a discrepancy is noted between the User's installation and the revenue metering register, the Network Operator shall correct the discrepancy within 2 days.~~

~~(b) If as a result of the correction of the revenue metering register it indicates that the revenue metering installation or check metering installation does not comply with the requirements of this clause, the Network Operator shall use its reasonable endeavours to rectify the situation in regard to the revenue metering installation. If the check metering installation does not comply with~~

~~the requirement of this clause, reference to it will be deleted from the revenue metering register.~~

## **2.6 — Testing of metering installation**

- ~~(a) Testing of a revenue metering installation shall be carried out in accordance with the Network Operator's metering manuals.~~
- ~~(b) A User may request the Network Operator to arrange for the testing of any User's revenue metering installation and the Network Operator shall not refuse any reasonable request.~~
- ~~(c) The User will have the right to be present at any such testing.~~
- ~~(d) The Network Operator shall arrange for sufficient audit testing of Users' revenue metering installations to satisfy itself that each revenue metering installation conforms to the requirements of this clause.~~
- ~~(e) The Network Operator shall have unfettered access to any User's revenue metering installation at any time for the purpose of testing the revenue metering installation.~~

### **10.6.1 Actions in event of non-compliance**

- ~~(a) If a revenue metering installation does not comply with the requirements of this clause, the Network Operator shall as soon as practical advise the User and arrange for the revenue metering installation to be made compliant with the requirements of this clause.~~
- ~~(b) The Network Operator shall in conjunction with the User make appropriate corrections to the revenue metering data to take account of any errors as a result of the non-compliance found in 10.6.1(a).~~

### **10.6.2 Audits of metering data**

- ~~(a) A User may request the Network Operator to conduct an audit to determine consistency between the data held in the revenue metering database and the revenue metering data held in the User's revenue metering installation.~~
- ~~(b) If there is an inconsistency between the data held in a revenue metering installation and the data held in the revenue metering database, the data held in the revenue metering installation is to be taken as prima facie evidence of the revenue metering data.~~

## **2.7 — Rights of access to metering data**

- ~~(a) The only persons entitled to have either direct or remote access to revenue metering data from a revenue metering installation, the revenue metering database or the revenue metering register in relation to a revenue metering point are:
  - ~~(1) the Network Operator; and~~~~

~~(2) — the User whose account statement relates to energy measured at that revenue metering point.~~

~~(b) — Electronic access to revenue metering data from a revenue metering installation shall only be provided where appropriate multi-level password revenue meters are installed and the appropriate software is obtained by the User.~~

## **2.8 — Security of metering installations**

### **10.8.1 — Security of metering equipment**

~~(a) — The Network Operator is responsible for the security of the revenue metering installation and will fit seals or other devices to prevent or disclose unauthorised access.~~

### **10.8.2 — Security controls**

~~(a) — The Network Operator is responsible for the security of revenue metering data held in the revenue metering installation and shall prevent local or remote access by suitable passwords and/or other security devices in accordance with clause 10.8.1.~~

~~(b) — The Network Operator shall keep records of electronic passwords secure.~~

~~(c) — The Network Operator may allocate a “read-only” password to a User where the revenue meters installed have provision for multi-level passwords.~~

### **10.8.3 — Changes to metering equipment, parameters and settings**

~~The Network Operator shall record all changes to revenue metering equipment, parameters and settings.~~

## **2.9 — Processing of metering data for settlement purposes**

### **10.9.1 — Metering databases**

~~(a) — The Network Operator will create, maintain and administer a revenue metering database containing information for each User revenue metering installation.~~

~~(b) — The revenue metering database shall include original energy readings and substitute calculated values where estimates may be required.~~

### **10.9.2 — Remote acquisition of data**

~~(a) — The Network Operator is responsible for the remote acquisition of revenue metering data and for storing and processing this data for settlement purposes.~~

~~(b) — If remote acquisition becomes unavailable, the Network Operator is responsible for obtaining the relevant revenue metering data from the revenue meters.~~

### **10.9.3** Periodic energy metering

Data relating to the amount of active and *reactive energy* passing through a *revenue metering installation* is normally collated in trading intervals of between 28 and 35 days inclusive unless it has been agreed between the *User* and the *Network Operator* that some other period will apply either on an ongoing or once-off basis.

### **10.9.4** Data validation and substitution

- (a) ~~At commissioning, the *Network Operator* will validate, on-site, the data being recorded by a *revenue metering installation* against the measurement of basic parameters and the *User's* estimation of load.~~
- (c) ~~Check metering data, where available, may be used by the *Network Operator* to validate *revenue metering data* provided that the check metering data has been appropriately adjusted for differences in *revenue metering installation* accuracy.~~
- (d) ~~For the purpose of settlement, check metering data, if available, may be substituted either in whole or part for some or whole of the *revenue metering* readings.~~
- (e) ~~If a check meter is not available or metering data cannot be recovered from the metering installation within the time required for settlements, then a substitute value is to be prepared by the *Network Operator* using a method agreed with the *User*.~~

### **10.9.5** Errors found in metering tests, inspections or audits

- (a) ~~If a *revenue metering installation* test, inspection or audit demonstrates that a component of the *revenue metering* has errors in excess of those permitted by its class and it is not possible to determine from other data when the error occurred, the error will be deemed to have occurred at a time halfway between the time the error was found and the time of the previous most recent test or inspection which demonstrated that the installation complied with Attachment 4 and the *Network Operator's* metering manuals.~~
- (b) ~~If a test or audit of a *revenue metering installation* demonstrates that a component of a *revenue metering system* has an error less than 1.5 times the error permitted for that component, then no substitution of readings is required.~~

### **10.9.6** Load following and out of balance energy

~~The *Network Operator* shall forward metering data to the *Power System Controller* for load following reconciliation and out of balance energy settlement.~~

## **2.10** Confidentiality

~~*Revenue metering data* and passwords are confidential data and are to be treated as confidential information.~~

## 2.11— Meter time

- ~~(a) All revenue metering installation clocks are to be referenced to Australian Central Standard Time and maintained to a standard of accuracy as required by Australian Standard AS 1284.~~
- ~~(b) The revenue metering database shall be set within an accuracy of  $\pm 10$  seconds of Australian Central Standard Time.~~

| 9.4 [Deleted]



10 [Deleted]

## **10.11 Information requirements for *network connection***

### **10.11.1 Scope**

- (a) The following information requirements apply to the *connection* of *Users* to the *Power and Water networks*.
- (b) The *Network Operator* is obliged to obtain sufficient information in respect of a *network connection* to enable the *Network Operator* to ensure that the relevant *User connection* will not prevent the *network* performance standards in clause ~~2-02~~ of the *Code* from being met.
- (c) If, in the opinion of the *Network Operator*, additional information for a particular *User connection* is required to ensure the *network* performance standards in clause ~~2-02~~ of the *Code* are met, the *User* shall *supply* the additional information.
- (d) The *User* shall provide all data reasonably required by the *Network Operator*.
- (e) Particular provisions may be waived for smaller *Users* and *Users* that have no potential to affect other *Users*, at the discretion of the *Network Operator*, in accordance with the *derogation* provisions of clause ~~12-012~~.
- (f) Nothing in this section waives the requirements for all installations to comply with the *Network Operator's* Service and Installation Rules, *Metering Manual*, Contractor's Bulletins, and any requirement included in ~~an Access Agreement~~ *connection agreement*.

### **10.211.2 Information to be provided by all ~~network~~*Network Users***

#### **10.2.11.2.1 Information on connected plant**

- (a) Before any new or additional equipment is *connected*, the *User* may be required to submit the following kinds of information to the *Network Operator*:
  - (1) a single line diagram with the *protection* details;
  - (2) *metering* system design details for equipment being provided by the ~~User~~ *User*;
  - (3) a general arrangement locating all the equipment on the site;
  - (4) a general arrangement for each new or altered *substation* showing all exits and the position of all electrical equipment;
  - (5) type test certificates for all new switchgear and *transformers*, including measurement *transformers* to be used for *metering* purposes in accordance with ~~clause 10 (metering) of this Code~~ *Chapter 7A of the NT NER*;
  - (6) the proposed methods of earthing cables and other equipment to comply with the Electricity Supply Association of Australia Substation Earthing Guide, or *Australian Standard AS3000*, or both, as appropriate;

(7) *plant* and earth grid test certificates from approved test authorities;

- (8) a primary/secondary injection test of *protection* and trip test certificates on all circuit breakers;
- (9) certification that all new equipment has been inspected before being connected to the supply;  
~~connected to the supply~~;
- (10) operational procedures;
- (11) calculated maximum *demand* of the installation;
- (12) details of potentially disturbing *loads*; and
- (13) SCADA arrangements.

(b) Details of the kinds of data that may be required are included in Attachment 3.

### 10.2.211.2.2 Details of proposed Users' protection

(a) Unless otherwise agreed by the *Network Operator*, *Users* shall provide the *Network Operator* with full details of proposed *protection* designs, together with all relevant *plant* parameters, a minimum of 12 months prior to energisation of the protected *primary plant*.

- ~~(a)~~ The *Network Operator* shall provide comments on a *User's* proposed
- (b) *protection* designs within 65 *business days*, unless otherwise agreed.

### 10.2.311.2.3 Requirements where a critical fault clearance time exists

(a) Where a *critical fault clearance time* exists, *Users* shall maintain a record of design *fault clearance times* for all circuit breakers within their *plant*.

- ~~(b)~~ Records of design *fault clearance times* shall be made available to the
- (b) *Network Operator* on request.

### ~~2.12~~ Information to be provided by Users with Generators

- ~~(a)~~ A *User* with a *Generator* shall provide the data specified in clause 11.2.
- ~~(b)~~ The *User* shall provide all other data reasonably required by the *Network Operator*. This data shall include, without limitation, full models (and all model parameters) of:
  - ~~(1)~~ the *Generation Units*;
  - ~~(1)~~ the *excitation control systems*;
  - ~~(2)~~ *turbine / engine governor systems*; and
  - ~~(3)~~ *power system stabilisers*;
  - ~~(4)~~ to enable the *Network Operator* to conduct dynamic simulations.
- ~~(c)~~ These models shall be in a form which is compatible with the *power system analysis software* used by the *Network Operator* (currently PSS/E from

Siemens PTI) and shall be inherently stable.

~~(d) Details of the kinds of data that may be required are included in Attachment 3 of this Code, specifically:~~

~~(1) Schedule S3.1 - Generation Unit design data;~~

~~(2) Schedule S3.2 - Generation Unit setting data;~~

~~(2)(1) Schedule S3.5 - Network and plant technical data; and~~

~~(3)(1) Schedule S3.6 - Network plant and apparatus setting data.~~

### **11.3 [Deleted]**

#### **10-311.4 Information to be provided by Users with Small Generators**

- (a) A User with a Small Generator shall provide the data specified in clause ~~11.2~~ 11.2.
- (b) A Small Generator shall provide all information in relation to the design, construction, operation and configuration of that small power station as is required by the Network Operator to ensure that the operation and performance standards of the network, or other Users, are not adversely affected by the operation of the power station.
- (c) In order to assess the impact of the equipment on the operation and performance of the network or on other Users, the Network Operator may require a Small Generator to provide data on:
- (1) power station and ~~Generation Unit~~generating unit aggregate real and reactive power; and
  - (2) flicker coefficients and harmonic profile of the equipment, where applicable and especially for wind power and inverter connected equipment. Data on power quality characteristics, including flicker and harmonics, in accordance with IEC 61400- 21 shall be provided for all wind turbines.
- (d) Net import / export data shall be provided in the form of:
- (1) a typical 24 hour power curve measured at 15 minute intervals (or better if available); and
  - (2) details of the maximum kVA output over a 60 second interval, or such other form as specified in the relevant ~~Access Agreement~~connection agreement.
- (e) When requested by the Network Operator, a Small Generator shall provide details of the proposed operation of the equipment during start-up, shut-down, normal daily operation, intermittent fuel or wind variations and under fault or emergency conditions.
- (f) Details of the kinds of data that may be required are included in Attachment 3 of this Code, specifically:
- (1) Schedule S3.3 - Generator data for ~~Small Generation Units~~small generating systems;
  - (2) Schedule S3.5 - Network and plant technical data; and
  - (3) Schedule S3.6 - Network plant and apparatus setting data.

#### **10.411.5 Information to be provided by Users with Small Inverter Energy Systems**

*A Small Inverter Energy System may be installed as an addition to an existing load connection, in conjunction with a new load connection or as a stand-alone Generation system.*

*A Small Inverter Energy System may be installed as an addition to an existing load connection, in conjunction with a new load connection or as a stand-alone Generation system.*

- (a) A User with a Small Inverter Energy System shall provide the data specified in clause [11.2.11.2](#).
- (b) Details of the kinds of data that may be required from a User with a Small Inverter Energy System are included in Attachment 3 of this Code, specifically:
  - (1) Schedule S3.4 - Technical data for Small Inverter Energy Systems;
  - (2) Schedule S3.5 - Network and plant technical data;
  - (3) Schedule S3.6 - Network plant and apparatus setting data; and
  - (4) Schedule S3.7 - Load characteristics at connection point.

#### **10.511.6 Information to be provided by Users with loads**

- (a) A User with a ~~Load~~load shall provide the data specified in clause [11.2.11.2](#).
- (b) Details of the kinds of data that may be required from a User with a Load are included in Attachment 3 of this Code, specifically:
  - (1) Schedule S3.5 - Network and plant technical data;
  - (2) Schedule S3.6 - Network plant and apparatus setting data; and
  - (3) Schedule S3.7 - Load characteristics at connection point.

## 11.12 **Derogations** Transitional arrangements and derogations from the *Code*

### 11.12.1 Purpose and application

- (a) This clause ~~12.012~~ prevails over all other clauses of this *Code*.
- (b) *Derogations of Users* are:
- (1) those provisions of the other clauses of the *Code* which shall not apply either in whole or part to particular *Users* or potential *Users* or others in relation to their *facilities* for a fixed or indeterminate period;
  - (2) any provisions which substitute for those provisions which are not to apply; and
  - (3) applicable only to that particular *User* or potential *User*.
- (c) *Derogations* are for the purpose of:
- (1) enabling *Users* to effect an orderly transition to the provisions of the *Code* from those provisions currently applying (including extension of a grace period set out in Schedule S4);  
~~from those provisions currently applying;~~
  - (2) providing specific exemptions from the *Code* for pre-existing arrangements which the *Network Operator* determines shall continue beyond a specific transition period; and
  - (3) providing specific exemptions from the *Code* for future arrangements (implemented after the introduction of a new version of this *Code*) that the *Network Operator* determines to be acceptable.
- (d) The *Network Operator* is not required to grant a *derogation* if doing so will adversely affect *network capability, power system security, quality or reliability of supply, intra-regional power transfer capability* or the use of a *network* by another *User*.
- (e) An applicant for a *derogation* must submit that application in such form reasonably required by the *Network Operator* which application must outline:
- (1) the nature of the *derogation* sought;
  - (2) why the *derogation* should be granted;
  - (3) why granting of the *derogation* will not have the effect referred to in clause 12.1(d).
- (f) Applications for *derogations* under clause 12.1(b)(1) and (2) may be granted if the *Network Operator* in good faith forms the view that the *derogation* is appropriate given the pre-existing arrangements to which the *User* is party and having regard to the criteria in clause 12.1(d).



(g) In considering applications under clause 12.1(b)(3) the Network Operator must apply the principle that Users first applying to connect to the electricity network after the commencement of Version 4 of this Code should comply with the standards in this Code and that derogations should only be granted to small Users who have only minor impact upon the electricity network (including when their impact is aggregated with other small Users) or where there are otherwise compelling reasons for granting the derogation.

~~(d)~~(h) Applications for derogations shall be submitted to and processed by the Network Operator in accordance with the Electricity Networks (Third Party Access) Act 2014 any requirement of applicable laws.

### **~~2.13~~ Networks and facilities existing at Pre 1 September 2012**

#### **~~12.2~~ All April 2019 plant and equipment in the Network and all facilities**

(a) This clause applies to plant of a Generator User connected to this the electricity network existing at prior to 1 September 2012 are deemed to April 2019 (such plant and equipment being Existing Connection Plant).

(b) A Generator User to whom this clause applies must, in respect of the Existing Connection Plant:

(i) comply with the requirements technical standards applicable to such Existing Connection Plant under Version 3 of this Code. If at any time it is found that an installation is adversely affecting power system security, reliability of the power system and/or (as in force immediately prior to the quality of supply date Version 4 of this Code came into effect); and

(ii) comply with clause 3 of this Code (Technical requirements for equipment connected to the network) including the automatic access standards set out in that clause 3 to the extent the Existing Connection Plant is able (without requiring modification, alteration or enhancement) to comply with that clause and those automatic access standards.

(c) A Generator User to whom this clause applies must, if required by the Network Operator, conduct such tests as required by the Network Operator to determine the extent to which the Existing Connection Plant of the Generator User is able to comply with clause 3, including the automatic access standards. Such tests must be conducted at the times and otherwise in accordance with the requirements reasonably determined by the Network Operator.

(d) The Generator User must report the results of the tests to the Network Operator in such manner specified by the Network Operator acting reasonably.

(e) The Generator User must bear its own costs of undertaking the tests required by the Network Operator and must reimburse the Network Operator, at such times reasonably determined by the Network Operator, the Network Operator's reasonable costs of conducting and overseeing such tests.

(f) If a Generator User materially modifies, alters or enhances Existing Connection Plant, then it must do so, if required by the Network Operator, in accordance with any

applicable provisions of the NT NER and this Code (including where required by this Code complying with the automatic access standards or such negotiated access standards as may be agreed).

### **12.3 Post 1 April 2019 plant and equipment**

- (a) This clause applies to a Generator User who has entered into a connection agreement with the Network Operator prior to Version 4 of this Code coming into effect but had not completed the connection of plant and equipment to the electricity network prior to 1 April 2019.
- (b) Subject to this clause 12.3, such Generator User must ensure all plant and equipment connected to the electricity network pursuant to that connection agreement complies with the requirements of this Code including (subject to paragraph (c) below) the automatic access standards. However where a grace period for a technical requirement is specified in Schedule S4 a Generator User will not be regarded as in breach of this Code if:
- (i) within 30 days of commencement of version [4] of this Code it submits to the Network Operator a written communication confirming each automatic access standard that is met, and for each individual automatic access standard that is not met, a plan setting out the procedures, consistent with good electricity industry practice, which will be followed by the Generator User to ensure it complies with that technical requirement from the end of the applicable grace period; and
  - (ii) it complies with that plan; and
  - (iii) it ensures it complies with that technical requirement as soon as reasonably practicable and in any event from the end of the relevant User shall be responsible for remedying the problem applicable grace period.
- (c) A plan submitted under clause 12.3(b):
- (i) may include a process for negotiating a negotiated access standard; and
  - (ii) must include the testing and commissioning procedures which will be followed by the Generator User to establish it has achieved compliance with each relevant technical requirement.
- (d) A Generator User must make such changes to a plan submitted under clause 12.3(b) as reasonably required by the Network Operator.
- (e) A Generator User to whom this clause applies may request the Network Operator to agree with it a negotiated access standard in substitution for an automatic access standard and, if so, the Network Operator will negotiate in good faith with the Generator User to agree such negotiated access standard in accordance with the criteria set out in clause 3.3.5. Until such time as a negotiated access standard is agreed, any connected plant of the Generator User must, subject to clause 12.3(b), comply with the automatic access standard.

- (f) Where this Code contemplates a matter being agreed between the Network Operator and the Generator User and such matter is not specified in the connection agreement then:
- (i) the Network Operator may, as a condition to connecting the plant to the electricity network and permitting its commissioning, require that the Network Operator and the Generator User agree such matters and document them as an amendment to the connection agreement; or
- (ii) if the plant is already connected and commissioned as ~~at its cost,~~ the time Version 4 of this Code comes into effect, the Generating User must, if required by the Network Operator, negotiate in good faith to agree and document such matters by an amendment to the connection agreement (and if such matters are not agreed within 4 months of the Network Operator's request then the matter may be referred for determination by the Utilities Commission under clause 1.6(b)).

- (g) The *Generator User* must report the results of the tests conducted in accordance with a plan referred to in clause 12.3(b) to the *Network Operator* in such manner specified by the *Network Operator* acting reasonably. The *Generator User* must bear its own costs of undertaking such tests.
- (h) Any grace periods referred to in this clause 12.3 shall only commence from the date that the *Network Operator* provides the *Generator User* with information and guidelines specified in clauses 3.3.4 and 3.3.5 to enable the *Generator User* to determine the ability of their plant to comply with the technical requirements in 3.3.5.

## Part C Network Planning Criteria

*Power and Water is the major custodian and operator of the power networks within the Northern Territory. Power and Water is responsible for the network security, reliability and quality of supply to all network Users. Power and Water's technical requirements are intended to ensure that a high reliability of service is maintained when additions and changes to the networks or Users' installations are made. Technical requirements are based on the rules, criteria and limits included in the Technical Code and these Network Planning Criteria.*

*The Network Planning Criteria provide for the requirements of the legislated Third Party Access regime, which permits network customers to use Power and Water's regulated networks to enable contracted trade between Generator Users and customer Users.*

*The purpose of Network Planning Criteria is to strike a balance between each User's need for a safe, secure, reliable, high quality electricity supply and the desire for this service to be provided at minimal cost. At the same time, environmental and social considerations shall be taken into account.*

*Power and Water is the major custodian and operator of the power networks within the Northern Territory. Power and Water is responsible for the network security, reliability and quality of supply to all Network Users. Power and Water's technical requirements are intended to ensure that a high reliability of service is maintained when additions and changes to the networks or Users' installations are made. Technical requirements are based on the rules, criteria and limits included in the Technical Code and these Network Planning Criteria.*

*The Network Planning Criteria allow network customers to use Power and Water's regulated networks to enable contracted trade between Generator Users and customer Users.*

*The purpose of Network Planning Criteria is to strike a balance between each User's need for a safe, secure, reliable, high quality electricity supply and the desire for this service to be provided at minimal cost. At the same time, environmental and social considerations shall be taken into account.*

### 1213 Introduction

- (a) Additions to and reinforcement of the networks in the form of additional:
- (1) Transmission lines and distribution feeders;
  - (2) Transformers;
  - (3) Generators;
  - (4) Loads; and

- (5) Capacitors or *reactors*;  
will produce an impact on the existing *networks* and *customers*.
- (b) This Part C presents the *Planning Criteria* applied to ensure that *Power and Water's networks*:
  - (1) Provide a high quality electricity *supply*;
  - (2) Provide a *reliable* electricity *supply*;
  - (3) Provide a secure electricity *supply*;
  - (4) Meet safety standards;
  - (5) Meet environmental standards;
  - (6) Optimise equipment utilisation; and
  - (7) Optimise *network losses*.
- (c) The philosophy of *network* planning and the rationale behind the *Planning Criteria* are discussed in clause ~~13-1~~ 013-1 of this document.
- (d) The guidelines for *network* planning, which are provided in this document, outline the range of technical and environmental *Planning Criteria*.

### 12.113.1 Network design philosophy

- (a) The *Planning Criteria* are used to assess the *supply* system capacity and determine the need for and timing of:
- (1) *Generation* support;
  - (2) *Demand* management;
  - (3) *Network* reinforcement; or
  - (4) *Network* re-configuration;
- to meet *customers' demand* for electricity.

~~(a)~~ *Network* reinforcement plans may then be developed which will satisfy the

(b) *Planning Criteria* and environmental *constraints*.

### 12.213.2 Amendments to the Planning Criteria

- (a) Any ~~System-Participant~~User may propose an amendment to the *Planning Criteria*.

~~(b)~~ A proposal to amend the *Planning Criteria* shall be made in writing by the

(b) ~~System-Participant~~User to the *Network Operator* and shall be accompanied by:

- (1) the reasons for the proposed amendment to the *Planning Criteria*; and
- (2) an explanation of the effect on ~~System-Participants~~Users of the proposed amendment to the *Planning Criteria*.

- (c) ~~The~~Subject to paragraph (f) below, the *Network Operator* shall review the proposed amendment to the *Planning Criteria* and within 30 days advise the ~~System-Participant~~User or electricity entity:

- (1) whether the proposed amendment to the *Planning Criteria* is accepted or rejected; and
- (2) the reasons for the acceptance or rejection of the proposed amendment to the *Planning Criteria*.

~~(d)~~ The 30 day period in clause 13.2(c) is extended as reasonably required to allow any public consultation or consultation with the Utilities Commission required under the Electricity Reform Act.

~~(d)~~(e) The *Network Operator* shall review the operation of the *Planning Criteria* at intervals of no more than 5-years and may seek submissions from ~~System-Participants~~Users and the Utilities Commission during the course of the review.

~~(e)~~(f) The *Network Operator* may amend this *Planning Criteria* in accordance with the legislative provisions.

### 12.313.3 132-kV and 66-kV networks

The traditional planning philosophy for a meshed network has been that the loss of any one component of the network at a time of peak load will not result in the loss of supply to any customers. This is the 'n-1' criterion, which can result in imprudent capital expenditure if the frequency and consequences of breaching the criterion are not considered. Prudent capital expenditure involves the application of risk management techniques. This requires a consideration of the probability of an event occurring and the consequences of its occurrence, for example the impact on customers. If the probability of the event is low and the



~~consequences acceptable, it may be considered justified to delay system reinforcement beyond the date indicated by the n-1 criterion and peak loading.~~

~~The traditional planning philosophy for a meshed network has been that the loss of any one component of the network at a time of peak load will not result in the loss of supply to any customers. This is the 'n-1' criterion, which can result in imprudent capital expenditure if the frequency and consequences of breaching the criterion are not considered. Prudent capital expenditure involves the application of risk management techniques. This requires a consideration of the probability of an event occurring and the consequences of its occurrence, for example the impact on customers. If the probability of the event is low and the consequences acceptable, it may be considered justified to delay system reinforcement beyond the date indicated by the n-1 criterion and peak loading.~~

(a) Power and Water designs its 132-kV and 66-kV systems as meshed networks.

~~(e)~~ There may be radial 132-kV and 66-kV lines extending from the meshed

(b) network to many rural and developing areas.

(c) Generators are connected to the networks at voltages of 132-kV and 66-kV. The technical characteristics of Generator connections may be negotiated with the Generator provided that the network performance standards of clause 2.02 of the Network Technical Code are maintained.

#### 12.4.13.4 Distribution networks

Power and Water designs its distribution networks as radial systems.

##### 12.4.13.4.1 CBD area

(a) In the Darwin central business district, five 11-kV switching stations supply a network of underground HV feeder rings, with open points approximately mid-way between switching stations <sup>1</sup>.

(b) The switching stations are remotely controlled, but the intermediate switches used to transfer load and restore supply in the event of a supply contingency are operated manually.

##### 12.4.13.4.2 Urban areas

(a) In urban areas the lower density of Users generally results in an open, meshed network of HV feeders run radially with open points.

~~network of HV feeders run radially with open points.~~

(b) This operating mode minimises fault levels and simplifies technical and operational requirements.

<sup>1</sup> Power and Water's High Voltage (HV) networks operate at voltage levels of 22 kV in rural areas and 11 kV in urban areas.

- (c) In these situations, the extent of the loss of *supply* can be minimised by the use of reclosers and sectionalisers to limit the impact of faults and the speed of restoration improved through the use of fault indicators to locate faults.

### ~~12.4.3~~ 13.4.3 Rural areas

- ~~(a)~~ In rural areas the *distribution network* is generally radial and *interconnection* (a) to reduce *supply* restoration times is often not possible.
- (b) In normal circumstances the loss of a component of the *network* will result in the loss of *supply* to a number of *Users* until the *network* is reconfigured or repaired.

---

<sup>4</sup> ~~Power and Water's High Voltage (HV) networks operate at voltage levels of 22 kV in rural areas and 11 kV in urban areas.~~

#### 12.4.4 13.4.4 Enhanced security of supply

- ~~(b)~~—The *Network Operator* will provide for the reasonable request of a *User*
- (a) requiring additional security of *supply* above the standard design philosophy.
  - (b) Additional costs incurred in providing the additional security of *supply* would ordinarily be charged to the *User*.
  - (c) In some circumstances, on-site standby ~~Generation~~ *generation* may be the only economic or practical alternative to improve *supply* security.

#### 12.4.5 13.4.5 Embedded generation

- (a) The *distribution network* is not designed to support the islanded operation of *embedded Generators* and *Power and Water's distribution* equipment is not normally fitted with *synchronising* equipment.
- (b) Embedded ~~Generation Units~~ *generating units*, including small solar photo-voltaic and wind *Generators* at ~~network~~ *Network Users'* premises shall be of a design that automatically *disconnects* from the *network* if the *distribution* feeder that they are *connected* to is separated from the remainder of the *power system*.
- (c) The requirements concerning the *connection* of *Small Generators* and *Small Inverter Energy Systems* are set out in ~~clauses 3.4 and 3.5 of the Network Technical~~ *clauses 3.4 and 3.5 of this Code*.

#### 12.5 13.5 Process to assess the need for network reinforcement

- (a) *Network* capacity and the need for *network* reinforcement are assessed by comparing the *Planning Criteria* with *network* performance for:
  - (1) Increasing *load* levels;
  - (2) Changing *load demand* patterns;
  - (3) Particular *load* characteristics; and
  - (4) *Reliability*.
- (b) To satisfy the performance levels, be they *reliability*, security, or quality levels, least cost and effective plans are developed. The extent of the *network* reinforcement works is dependent on:
  - (1) The *load* forecast;
  - (2) The anticipated maximum *demands* of all *Users*;
  - (3) Special conditions of the *User's load*;
  - (4) The anticipated minimum *demand* of other *Users*;
  - (5) *Users' load* profiles;
  - (6) The availability of non-*network* alternatives to *network* reinforcement; and
  - (7) The age and condition of existing assets.

- (c) Economic analysis is used in assessing *network* reinforcement requirements and serves four functions as it:
  - (1) Indicates the return to *Power and Water* of proposed capital investment;
  - (2) Helps to choose between options;
  - (3) Helps rank the project with other projects *generated* throughout *Power and Water*; and
  - (4) Ensures the equitable allocation of costs between *Users*.
- (d) In some cases, *network* reinforcement works may also be justified on an economic basis where there are immediate benefits in return for capital invested, *e.g.g.* *network* loss optimisation.

### **12-613.6 The process of developing network concept plans**

- (a) *Power and Water*, in developing *network* concept plans for the long-term development of the *network*, uses ultimate *load* horizon planning.
- (b) In this methodology *Power and Water* considers the following information in assessing the ultimate *load* for an area:
  - (1) Department of Lands Planning and Environment land use structure plans;
  - (2) Australian Bureau of Statistics censuses;
  - (3) Consultants' reports on population growth in the major centres;
  - (4) Any relevant town planning schemes;
  - (5) Local Government advice on future planning proposals;
  - (6) Geographic features and their associated design limitations; and
  - (7) Any environmental *constraints*, including vegetation and ecology limitations.
- (c) This information is combined with any other available future *load* information to produce an ultimate *load* assessment for an area and on the basis of this a *network* concept plan is developed.

### **12-713.7 Planning Criteria**

*Planning Criteria* are a set of standards applied to maintain appropriate levels of *network* security and *reliability*. They are used as a planning and design tool to protect the interests of all *network* *Users* in terms of *reliability* and *quality of supply*. The criteria are also applied to protect all *networks* against instability.

### **12-813.8 Network development**

The *Network Operator* is required to ensure that non-*network* alternatives to the reinforcement of the *network* are considered on an equivalent basis to *network* reinforcement and adopted where they can economically meet the *network*

~~performance standards in clause 2 of the *Network Technical Code* and the *supply contingency criteria* in clause 14 of the *Network Planning Criteria*.~~

~~Non-network alternatives may include, without limitation, the following programs and technologies:~~

- ~~◆ Pricing signals to influence customer demand;~~
- ~~◆ Direct control of customer demand;~~
- ~~◆ Installation of power factor correction;~~
- ~~◆ Installation of embedded generation.~~

~~Non-network alternatives may involve agreements between the *Network Operator* and third parties for the provision of support to the *network* in specified~~

The *Network Operator* is required to ensure that non-network alternatives to the reinforcement of the *network* are considered on an equivalent basis to *network reinforcement* and adopted where they can economically meet the *network performance standards* in clause 02 of the *Network Technical Code* and the *supply contingency criteria* in clause 14 of the *Network Planning Criteria*.

Non-network alternatives may include, without limitation, the following programs and technologies:

- Pricing signals to influence *customer demand*;
- Direct control of *customer demand*;
- Installation of *power factor correction*;
- Installation of *embedded generation*.

Non-network alternatives may involve agreements between the *Network Operator* and third parties for the provision of support to the *network* in specified contingency conditions.

## ~~12.8.1~~ 13.8.1 Annual planning review

The *Network Operator* shall annually:

- (a) Prepare a forecast of loads and *generation* for the system for a period of at least 5 years.
- (b) Conduct a planning review of the adequacy of existing *connection points* and the capacity of the *transmission* and *distribution networks* to meet forecast *load demands* and *generation demands*.
- (c) Consider the potential for augmentations, or non-network alternatives to augmentations, that are likely to provide economic benefit to all ~~network~~*Network* Users.
- (d) Identify where *network investments* are likely to be required and classify those investments as:
  - (1) a *small network investment*; or

(2) a *large network investment*.

- (e) Prepare a *Network Management Plan* containing, amongst other things, *network limitations* and potential *non-network* and *network* solutions for *small network investments* and *large network investments* in a form suitable for public dissemination.
- (f) The *Network Management Plan* shall be made available on Power and Water's [web site](#) ~~website~~ and made available to the interested parties established in clause ~~13.8.2~~([13.8.2](#)(a) or to any person, upon application.

### ~~12.8.2~~[13.8.2](#) **Non-network alternatives to network augmentation**

- (a) The *Network Operator* shall establish and maintain a list of interested parties that may be prepared to provide *non-network* alternatives to augmentation of the *network*.

- (b) The *Network Operator* shall carry out a screening test to determine whether *demand* management or other non-*network* alternatives are likely to be viable for each *network investment* identified in clause ~~13.8.1~~13.8.1(d).
- (c) Where *demand* management or other non-*network* alternatives are not likely to be viable for a *network investment* the *Network Operator* shall carry out analysis of the *network* reinforcement in accordance with clause ~~13.9~~13.9.
- (d) Where *demand* management or other non-*network* alternatives are likely to be viable for a *large network investment*, the *Network Operator* shall:
  - (1) publish a report detailing the circumstances of the large network investment and the outcome of the demand management screening test in clause ~~13.8.2~~13.8.2(b);
  - (2) advise interested parties of the large network investment;
  - (3) seek expressions of interest in providing a non-*network* alternative.
- (e) If no expression of interest in providing a non-*network* alternative to a large network investment has been received within 60 business days the *Network Operator* shall carry out analysis of the *network* reinforcement in accordance with clause ~~13.9~~13.9.
- (f) Where *demand* management or other non-*network* alternatives are likely to be viable for a *small network investment*, the *Network Operator* shall inform interested parties of the outcome of the screening test in clause ~~13.8.2~~13.8.2(b) and request expressions of interest in providing a non-*network* alternative.
- (g) If no expression of interest in providing a non-*network* alternative to a small network investment has been received within 30 business days the *Network Operator* shall carry out analysis of the *network* reinforcement in accordance with clause ~~13.9~~13.9.
- (h) The *Network Operator* shall carry out the analysis of non-*network* alternatives provided by interested parties under clauses ~~13.8.2~~13.8.2(d) and ~~13.8.2~~13.8.2(f) in accordance with clause ~~13.9~~13.9.

## ~~12.9~~13.9 Investment analysis and reporting

In determining the preferred option for a new *large network investment*, the *Network Operator* shall:

~~*Network Operator* shall:~~

- (a) Analyse the proposed *large network investment* using financial parameters consistent with the most recent *Network* regulatory determination.
- (b) Analyse non-*network* alternatives and *network* reinforcement alternatives on the same basis.
- (c) Determine on a present value basis the least-cost non-*network* or *network* reinforcement alternative that meets the requirements of the *network*

performance standards in clause ~~2-02~~ of the *Code* and the *supply* contingency criteria in clause ~~14-14~~ of the *Network Planning Criteria*.



- (d) Include in the investment analysis an estimate of system benefits where they are likely to be material to the outcome of the analysis, including, but not limited to:
  - (1) Electrical losses;
  - (2) Changes in the level of involuntary *load* curtailment;
  - (3) Fuel and *generation costs*;
  - (4) *Ancillary services* provided to the system (e.g. *voltage support, spinning reserve or C-FCAS as applicable in each regulated power system*, black start).
- (e) The level of analysis undertaken in relation to system benefits in clause 13.9.13.9(c) shall be proportionate to the size and scale of the proposed new *network* investment.
- (f) Determine and assess any non-quantifiable economic benefits of alternative investment options.
- (g) Determine the preferred non-*network* or *network* investment alternative.
- (h) Prepare a report on the *network* investment analysis in clause 13.9.13.9(a) to (g).

## 13.14 Supply contingency criteria

- (a) *Supply contingency criteria* relate to the ability of the *supply system (network and Generation generation)* to be reconfigured after a fault, so that the *supply to customers* is restored. The criteria apply to *Generation generation* used to support the *network* and to the *network interconnections to Generators*.
- (b) The following definitions apply.

### 13.14.1 Load areas

- (a) The *load areas* that have been identified for the purpose of the *supply contingency criteria* are set out in *Figure 12*.  
contingency criteria are set out in *Table 11*.  
**Table 11** *Figure 12 - Definition of load types*

Load type	Definition
CBD	Any area within a city or town that is zoned as CBD in the Northern Territory Planning Scheme.
Urban	An area in which the majority of the land is zoned for residential and/or commercial and/or industrial use within a major centre in the Northern Territory and is not CBD.
Non-urban	Areas that are not Urban and not within a CBD but which are within a 50km radius of a CBD.
Remote	Areas outside a 50km radius from a CBD.

- (b) A distinction has been made between the *supply* contingency criteria applicable to CBD and Urban *load* areas, and those applicable to Non-urban and Remote *load* areas.
- (c) A *supply* contingency may involve the unplanned failure of an element of *network* equipment or the failure of a *Generator* used to support the *network* at a particular location.

### 13.214.2 Supply contingencies

- (a) A single *supply* contingency (first contingency) may involve the unplanned failure of an element of *network* equipment (a cable, line or *transformer*), or the failure of a *Generator* used to support the *network* or *supply loads* at a particular location.

~~A second contingency provision has been included, which is similar to that in the CBD areas of most other Australian capital cities. Other CBDs currently are planned to provide second contingency capability at the subtransmission and zone substation level, as follows:~~

- ~~• **Brisbane:** in one hour;~~
- ~~• **Melbourne:** in 30 minutes; and~~
- ~~• **Sydney:** in one hour.~~

~~The longer time permitted for restoration of the Darwin CBD system recognises that manual switching of load on the CBD HV network would be necessary to restore capability.~~

A second contingency provision has been included, which is similar to that in the CBD areas of most other Australian capital cities. Other CBDs currently are planned to provide second contingency capability at the subtransmission and zone substation level, as follows:

- **Brisbane:** in one hour;
- **Melbourne:** in 30 minutes; and
- **Sydney:** in one hour.

The longer time permitted for restoration of the Darwin CBD system recognises that manual switching of load on the CBD HV network would be necessary to restore capability.

- (b) A second *supply* contingency involves the concurrent failure of two elements, which could comprise *network* equipment or *Generators*.
- (c) In addition, at the discretion of the *Network Operator*, certain high impact but low risk failures such as the failure of a single zone *substation* HV *busbar*, or the failure of a both circuits of a double circuit line, shall be considered as second *contingency events*.

### ~~13.3~~14.3 Equipment capacities

Circuit capacities to be used in determining *supply* adequacy are the appropriate cyclic ratings for *network* equipment.

### ~~13.4~~14.4 Forecast demand

- (a) The forecast area *demand* used for determining *supply* adequacy is the coincident maximum *demand* for the *load* area, feeder or *transformer* concerned, with a 50% Probability of Exceedence.
- (b) In calculating the maximum *demand* in clause ~~14.4~~14.4(a), allowance shall be made for the coincident effect of *demand* reductions in the *load* area arising from:
  - (1) Any *demand* management initiative controlled by *Power and Water*;

- (2) Any customer contracted to Power and Water to reduce demand upon request;
- ~~(4)~~ The net effect of any embedded Generation used to provide a demand
- (3) reduction under an agreement with Power and Water; and
- (4) Small scale embedded Generation such as solar PV installations.

### 13.514.5 Radial supply arrangements

- (a) Where restoration of supply requires reinstatement or repair, a secure supply having an alternative path is not provided. Restoration targets are set out in ~~Table 12~~ ~~Figure 13~~ ~~Figure 13~~.

~~Table 12~~ ~~Figure 13~~ – Radial supply restoration targets

Radial supply contingency	Restoration target
For failure of a substation transformer	≤ 36 hours
For failure of a subtransmission line	≤ 6 hours (loads greater than 5MVA)
For failure of a subtransmission line	≤ 12 hours (loads less than 5MVA)

- (b) The restoration times in ~~Table 12~~ ~~Figure 13~~ ~~Figure 13~~ are Power and Water’s internal targets. They do not represent customer guarantees.
- (c) Actual restoration times will be based on ensuring staff safety and being able to access and address the asset related issues.

### 13.614.6 Supply contingency criteria

The supply contingency criteria in the Network Planning Criteria have been designed to facilitate the Network Operator providing the specified response in the most appropriate and economical manner for the particular circumstances. The response to ensuring that the supply contingency criteria are met may include one or more of the following responses:

- ◆ Augmentation of the network;
- ◆ Reduction of demand on the network using demand management;
- ◆ Connection of generation within the load area concerned;
- ◆ Commercial arrangements with generators to provide demand support in contingency conditions;
- ◆ Enhanced operational response;
- ◆ Enhanced control of network configuration;
- ◆ Contingency planning, using strategically positioned spare equipment or mobile equipment such as generators and transformers.

The supply contingency criteria in the Network Planning Criteria have been designed to facilitate the Network Operator providing the specified response in the most appropriate and economical manner for the particular circumstances. The response to ensuring that the supply contingency criteria are met may include one or more of the following responses:

- Augmentation of the network;
- Reduction of demand on the network using demand management;
- Connection of generation within the load area concerned;
- Commercial arrangements with generators to provide demand support in contingency conditions;
- Enhanced operational response;
- Enhanced control of network configuration;
- Contingency planning, using strategically positioned spare equipment or mobile equipment such as generators and transformers.

(a) The supply contingency criteria in this clause ~~14.6~~ 14.6 apply to loads and to groups of loads supplied by the network at various voltage levels and locations.



- (b) In determining the relevant supply contingencies to loads and groups of loads, the potential unavailability of:
  - (1) elements of the *network* that normally supply those loads;
  - (2) the *generators* that normally supply those loads; and
  - (3) the associated ~~generator~~ *Generator connections*;
 shall all be considered.
- (c) The relative likelihood (frequency) of *supply* contingencies shall also be considered by the *Network Operator*. ~~The Supply Contingency Criteria~~ requires that:
  - (1) The *equipment* that comprises elements of the system for the supply to loads and groups of loads shall be operated and maintained in such a way that the frequency of equipment unavailability is consistent with good industry practice; and
  - (2) The expected frequency of *supply* contingencies shall be considered by the *Network Operator* when developing options to maintain compliance with the *Supply Contingency Criteria*.
- (d) The *Network Operator* shall aim to meet reliability of *supply* objectives established by the *Regulator*.
- (e) Where the availability of *generation* is a factor in meeting the contingency criteria in a particular load area the *Network Operator* is required to consult with the relevant *Generators* to make appropriate allowance for ~~Generation Unit~~ *generating unit* maintenance.
- ~~(d)~~ The *Network Operator* may enter into commercial arrangements with a
  - (f) *Generator* to provide *demand* support in *supply* contingency conditions.
  - (g) The *Planning Criteria* in ~~Table 13-Figure 14~~ *Figure 14* apply for the specified *supply* contingencies in CBD and Urban areas.
  - (h) The *Planning Criteria* in ~~Table 14-Figure 15~~ *Figure 15* apply for Non-Urban and Remote areas.
  - (i) The *Planning Criteria* in ~~Table 13-Figure 14~~ *Figure 14* and ~~Table 14-Figure 15~~ *Figure 15* apply to each load segment within the loads or groups of loads to which the associated *Planning Criterion* applies.

Table 13 Figure 14 - Supply contingency criteria - CBD and Urban areas

Class of supply	Forecast area demand	Minimum demand to be met after:		Notes
		First supply contingency	Second supply contingency	
A	Up to 1MVA	Within 8 hours: area demand	No special provision	Area demand is normally supplied from one source. Restoration of supply requires reinstatement or repair. Includes most HV customer connections and distribution substations. Where a single transformer supplies demand, the area demand may cover the transformer cyclic capacity.
B	Over 1 MVA and up to 5 MVA	(a) Within 3 hours: area demand less 1 MVA (b) Within 8 hours: area demand		Area demand is normally supplied from one source and may have partial to full supply available from an alternative source. Includes most HV feeders, allows for manual field switching.
C	Over 5 MVA and up to 50 MVA	(a) Within 60 minutes: area demand		Area demand is normally supplied from one or more source and will have partial to full supply from an alternative source. Will include many HV feeders and all zone substations. Area demand will be restored with automatic or manual switching of alternative sources of supply.
D	Over 50 MVA	(a) Immediate restoration of area demand	(b) Within time to restore planned outage: area demand (b)-(c) Within 5 hours: area demand	Area demand will normally be supplied by more than two alternative circuits with high level automatic and supervisory switching. The time permitted for restoration of supply to the Darwin CBD following a second contingency recognises that manual switching of load on the CBD HV network would be necessary. The second contingency provision is not intended to restrict the period during which maintenance can be scheduled. The provision for a second circuit outage assumes that normal maintenance would be undertaken when demand is less than peak.

Split Cells

Split Cells



Table 14

Figure 15 - Supply contingency criteria - Non-Urban and Remote areas

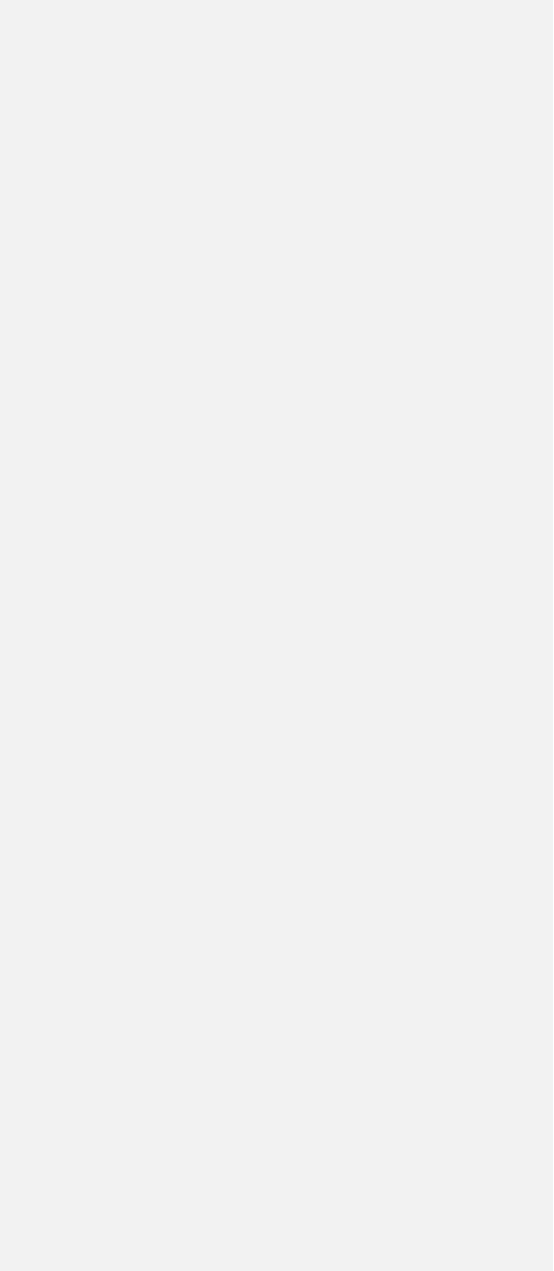

Class of supply	Forecast area demand	Minimum demand to be met after:		Notes
		First supply contingency	Second supply contingency	
E	Up to 1MVA	Within 12 hours: area demand	No special provision	Area demand is normally supplied from one source. Restoration of supply requires reinstatement or repair. Includes most rural spur connections, HV customer connections and distribution substations. Where a single transformer supplies demand, the area demand may cover the transformer cyclic capacity.
F	Over 1 MVA and up to 5 MVA	(a) Within 6 hours: area demand less 1 MVA (b) Within 12 hours: area demand		Area demand is normally supplied from one source and will have partial to full supply available from an alternative source. Full restoration of supply may require reinstatement or repair. Includes most HV feeders, allows for manual field switching.
G	Over 5 MVA and up to 15 MVA	(a) Within 3 hours: area demand (b) Within 36 hours: area demand		Area demand is normally supplied from more than one source and will have full supply from an alternative source. Includes many zone substations. Area demand will be restored with manual switching of alternative sources of supply. Where area demand supplied from a single source (b) will apply.
H	Over 15 MVA and up to 50 MVA	(a) Within 30 minutes: area demand (b) Within 36 hours: area demand		Area demand is normally supplied from more than one source and will have full supply from an alternative source. Will cover larger zone substations. Area demand will be restored with automatic or remote manual switching of alternative sources of supply. Where area demand supplied from a single source (b) will apply.

Split Cells

Split Cells



## 14.15 Steady state criteria

- (a) The steady state criteria define the adequacy of the *network* to *supply* the *energy* requirements of *Users* within the equipment ratings, *frequency* and *voltage* limits, taking account of planned and unplanned *outages*.
- (b) The steady state criteria apply to the normal continuous behaviour of a *network* and also cover post disturbance behaviour once the *network* has settled.
- (c) In planning a *network* it is necessary to assess the *reactive power* requirements under both extremes of light and heavy *load*, to ensure that the reactive *demand* placed on the *Generators*, be it to absorb or generate *reactive power*, does not exceed the capability of the *Generators* and that system *voltage* levels remain within equipment ratings.
- (d) *Network frequency* will fall if there is insufficient total *Generation* to meet *demand*. Although the reduction in *frequency* will cause a reduction in power *demand*, it is unlikely that this will be sufficient and in the event of a shortfall of *Generation*, *loads* shall be *disconnected* until the *frequency* rises to an acceptable level.
- (e) In the following sub-clauses, the various components of the steady state *Planning Criteria* are defined.

~~Planning Criteria are defined.~~

### 14.115.1 Real and reactive generating limits

- (a) Limits to the VAR *Generation* and absorption capability of *Generators* shall not be exceeded.
- (b) *Generators* shall be specified and maintained so as to be capable of operating within the normal range of system *voltage* at their point of *connection*.

### 14.215.2 Steady state power frequency voltage

~~The range of steady state voltage at different voltage levels of the power system under normal operating conditions is set out in this clause.~~

~~The Australian Standard for low voltage was altered in 2000. Australian Standard AS 60038-2000 establishes a revised nominal voltage of 230/400 V (single/three phase), to match the European standard set out in IEC 60038:1983.~~

~~Australian Standard AS 6038-2000 notes that 240/415 V systems shall evolve towards the new standard and a revised supply voltage range. Power and Water is participating in an Energy Networks Association review of issues associated with the potential migration from nominal voltages of 240 V to 230 V.~~

The range of steady-state voltage at different voltage levels of the power system under normal operating conditions is set out in this clause.

The Australian Standard for low voltage was altered in 2000. Australian Standard AS 60038:2000 establishes a revised nominal voltage of 230/400 V (single/three phase), to match the European standard set out in IEC 60038:1983.

Australian Standard AS 6038-2000 notes that 240/415 V systems shall evolve towards the new standard and a revised supply voltage range. Power and Water is participating in an Energy Networks Association review of issues associated with the potential migration from a nominal mid- range voltage of 240 V to 230 V.

- (a) For voltages of 11- kV or more, the *network* shall be planned and designed to maintain a continuous *network voltage* at a *User's connection* not exceeding the design limit of 110% of nominal *voltage* and not falling below 90% of nominal *voltage* during normal and maintenance conditions.

- (b) The *network* shall be designed to maintain the *low voltage* steady state levels within the range set out in ~~Table 15~~ ~~Figure 16~~ ~~Figure 16~~ for *credible contingency events*. These are referenced to the nominal *voltage* of 230/400 V.

~~Table 15~~ ~~Figure 16~~ – **Supply voltage range**

System condition	Lower range	Upper range
Normal conditions	- 2%	+ 11%
Planned maintenance conditions	- 4%	+ 13%
Unplanned <i>outage</i> conditions	- 6%	+ 15%

- (c) The power *frequency voltage* may vary outside the ranges set out in this clause ~~15-2~~ ~~15.2~~ as a result of a *non-credible contingency event*.

### ~~14.3~~ ~~15.3~~ Thermal rating criteria

- (a) It should be noted that the thermal rating limits of equipment might not determine the capability of the *network* in a particular situation. Other factors such as the *voltage* drop or rise, *voltage* stability or system stability may impose a lower limit in certain circumstances.
- (b) The thermal ratings of *network* components shall not be exceeded under normal or emergency operating conditions when calculated on the following basis:
- ~~(1)~~ **Transformers:** Manufacturer's name plate rating, unless specific
    - (1) ~~modelling~~ has been carried out to determine a cyclic rating for the anticipated cyclic *loading* and ambient temperature conditions.
    - (2) **Switchgear:** Manufacturer's name plate rating.
    - ~~(2)~~ **Overhead Lines:** ~~Rating~~ Rating calculated in accordance with ESAA Code
      - (3) ~~D(b)5~~, and based on:
        - (i) ambient temperature of 35°C in the northern part of the Territory, and 40°C (summer) or 25°C (winter) in the southern part;
        - (ii) wind speed being 0.5 m/s;
        - (iii) solar radiation being 1000W/m<sup>2</sup> (weathered surface); and
        - (iv) conductor design clearance temperature as defined in ESAA Code ~~C(b)~~.
      - ~~(3)~~ **Cables:** Normal cyclic rating, calculated using the Neher
        - (4) ~~McGrath~~ methodology; with
          - (i) maximum operating temperatures of 90°C for XLPE cables;
          - (ii) 70°C for 11-kV paper insulated cable;
          - (iii) 65°C for 11-kV paper insulated, belted cable and 22-kV paper insulated cables and;

- (iv) during an emergency, for a period of up to 12 hours, the maximum allowable operating temperature for paper insulated cables may be increased to 80°C and for XLPE insulated cables to 120°C.

~~It should be noted that the thermal rating limits of equipment might not determine the capability of the network in a particular situation. Other factors such as the voltage drop or rise, voltage stability or system stability may impose a lower limit in certain circumstances.~~

It should be noted that the thermal rating limits of equipment might not determine the capability of the network in a particular situation. Other factors such as the voltage drop or rise, voltage stability or system stability may impose a lower limit in certain circumstances.

#### 14.415.4 Fault rating criteria

~~For safety reasons, the fault rating of any equipment shall not be less than the fault level in that part of the network at any time and for any normal network configuration.~~

~~As the system configuration is changed, fault levels may increase over time. New connections to the network shall therefore be designed with equipment fault level ratings reflecting modern standards that may exceed existing fault levels.~~

For safety reasons, the fault rating of any equipment shall not be less than the fault level in that part of the network at any time and for any normal network configuration.

As the system configuration is changed, fault levels may increase over time. New connections to the network shall therefore be designed with equipment fault level ratings reflecting modern standards that may exceed existing fault levels.

- (a) The minimum fault levels for equipment to be connected to Power and Water's networks are set out in ~~Table 16~~Figure 17~~Figure 17~~.

~~Table 16~~Figure 17 – Network equipment fault level ratings

<b>Network voltage level</b>	<b>Fault level rupturing capacity</b>
415 V	31.5 kA where supplied from one transformer; or 63 kA where supplied from two transformers in parallel
11 kV	25 kA in metropolitan areas; 20 kA in rural areas
22 kV	15 kA
66 kV	31 kA
132 kV	31 kA

- ~~(e)~~ Equipment owned by Power and Water and Users connected to the network (b) shall be designed to withstand these fault levels for 1 second.

## 1516 Stability criteria

- (a) A *power system* is stable if it returns to a steady-state or equilibrium operating condition following a disturbance. This criterion shall hold true for all *loading* conditions and ~~Generation~~*generation* schedules, under normal operating conditions, following the loss of any item of *plant*, and for the most severe credible faults.
- (b) In the planning and operation of a *power system*, it is important to consider the potential emergence of a variety of stability problems.



- (c) The *Network Planning Criteria* are designed to ensure that the *network* has a high probability of returning to stable conditions, following all credible *network* disturbances.
- (d) The stability of a *power system* can be classified into a number of categories to facilitate the analysis of stability problems, the identification of contributing factors, and the development of measures to control or prevent instability. Instability can take many different forms and is influenced by a wide range of factors.
- (e) Two broad categories of stability are considered:
  - (1) Angle stability, which mainly involves the dynamics of *Generators* and their associated *control systems*. Angle stability can be further categorised into transient stability and small-signal or steady-state stability. *Frequency* stability is closely related to angle stability.
  - (2) *Voltage* stability, which mainly involves the dynamic characteristics of *loads* and *reactive power* compensation. *Voltage* collapse is perhaps the most widely recognised form of *voltage* instability.

#### 15.116.1 **Transient Angle stability**

Transient stability is the inherent ability of a power system to remain stable and maintain network synchronism when subjected to severe disturbances such as three phase faults on power lines, loss of Generation, loss of a large load or other failures. Such large disturbances need to be cleared in order to prevent network instability and physical damage to plant.

Transient stability is assessed on the basis of the first angular swing following a solid three phase fault or single phase to ground fault on one circuit at the most critical location that is cleared by the faster of the two protection schemes with all intertrips assumed in service.

#### 15.1.116.1.1 **Transient stability criteria**

- (a) Transient stability is based on the relative rotor angle swing between two or more groups of synchronous machines when subjected to a disturbance. Relative rotor angle swings in excess of  $90^{\circ}$  may lead to the situation where the rotor angle does not return and increases beyond  $180^{\circ}$ , resulting in pole slipping or synchronous instability. Transient stability of the *power system* shall be maintained. To ensure transient stability is maintained, due consideration during system studies shall be given to the following:
  - (1) the maximum allowable relative rotor angle swing between any two or more groups of *Generators* on the *network* shall not exceed  $180^{\circ}$  (after allowing for a safety margin consistent with *good electricity industry practice*);
  - (2) the transient *voltage* dip limit as specified in clause 16.2.6; 16.2.6; and
  - (3) the possibility of delayed clearance of faults on the *network*.

- (b) The most severe disturbance is to be selected from the following fault types to determine the stability of the *power system* (with due regard to be taken of reclosing onto a fault):
- (1) a three-phase-to-earth fault;
  - (2) a single phase to earth fault cleared by *backup protection*;
  - (3) high speed single phase auto-reclosing and
  - (4) sudden *disconnection* of any *plant*, including a *Generation Unit/generating unit*.
- (c) If the rotor angles between one (or a group) of synchronous machines and the rest of the *Generation Units/generating units* on the *network* reaches and/or exceeds 180°, a “pole slip” occurs. This results in loss of synchronism or synchronous instability.

### ~~15.1.2~~16.1.2 Rotor angle swing

- (a) — In general, an initial *Generator* rotor angle swing which does not exceed 120° and with  $X_T \leq 1.0$  p.u. is considered stable.
- (b) A rotor angle swing exceeding 120° has only a small margin before pole slipping, and an initial rotor swing angle which is higher than 120° may result in a pole slip or repeated pole slipping which is considered unstable.
- (c) The relative rotor angle concept of synchronous instability is based on the rotor angle between two synchronous machines. In the case of two or more *Generation/generation* groups containing various *Generators* a correlated effect on the *network*, like transient *voltage* dip limits, shall be used to prevent synchronous instability.
- (d) Rotor angle swings in excess of 120° or transient *voltage* dips in excess of 25% can result in the following detrimental effects on the *network*:
- (1) *Network voltage* collapse; and
  - (2) *Motor load* loss on *undervoltage*.
- (e) Such impacts on a *network* are not acceptable and enforceable limits need to be used to prevent them.

### ~~15.1.3~~16.1.3 Fault clearance time

- (a) One of the major factors affecting transient stability is the *fault clearance time*. The *critical fault clearance time* is the longest *time* that a fault can be allowed to remain on the *network* whilst maintaining *network* stability. *Protection* shall be installed to ensure that the *critical fault clearance times* are achieved.
- (b) A three-phase fault or a single-phase to ground fault (whichever is the more severe criterion), cleared by the primary *protection*, is selected by *Power and Water* as the basis for establishing transient stability. These faults shall be cleared within the *critical fault clearance time*.

(c) Transient stability shall be maintained for faults cleared by the tripping of any *network* element or a *Generator* under the worst possible *network load* or ~~Generation~~ *generation* pattern.

~~(b)~~ Any *plant* leading to *network* instability shall be separated from the healthy

(d) *network*.

#### ~~15.1.4~~ 16.1.4 Rotor angle swing and transient voltage dip

(a) Rotor angle swing is not a practical parameter to be in field measured, but a measurable impact on *Users* is the transient *voltage* dip (TVD) resulting from real power swings.

(b) Any *Generator connected* to the *distribution network* shall not cause the *Transmission voltage* to exceed the transient *voltage* dip criteria defined in the *Network Technical Code*.

#### ~~15.1.5~~ 16.1.5 Pole slip protection

(a) The function of pole slip *protection* is to remove an unstable *Generator* from the *network* and prevent the disturbance from causing problems with other *Users*. *Pole slip protection* only removes the pole-slipping *Generator* from the *network* after the machine has slipped at least one pole.

(b) Pole slip *protection* is to be installed on all ~~Generation Units~~ *generating units* where simulations show that pole slipping is likely following any credible *plant outage* or fault.

#### ~~15.1.6~~ 16.1.6 Small-signal stability

(a) A *power system* is small-signal stable for a particular steady-state operating condition if, following any small disturbance, it reaches an equilibrium condition which is identical or close to the pre-disturbance condition. Small disturbances include the continuously changing system *load*, OLTC operations, and minor switching operations.

(b) Small-signal instability may be oscillatory, where undamped rotor angle oscillations grow to dangerous magnitudes, or monotonic, where rotor angle differences increase in one *direction*. In either case ~~Generation Units~~ *generating units* can fall out of synchronism with each other and pole slipping can occur.

(c) Small-signal stability is assessed on the basis of the damping design criterion which states that "System damping is considered adequate if, at any credible operating point, after the most critical *single contingency*, simulations indicate that the halving *time* of the least damped electromechanical mode of oscillation is not more than 5 sec. (The 5 sec. halving *time* corresponds to a damping constant of 0.14 Nepers/sec.)."

(d) Statistical effects shall be taken into account when analysing test results.

## 16.2 Transient stability

Transient stability is the inherent ability of a *power system* to remain stable and maintain *network* synchronism when subjected to severe disturbances such as three-phase faults on *power lines*, loss of *generation*, loss of a large *load* or other failures. Such large disturbances need to be cleared in order to prevent *network* instability and physical damage to *plant*.

Transient stability is assessed on the basis of the first angular swing following a solid three phase fault or single phase-to-ground fault on one circuit at the most critical location that is cleared by the faster of the two *protection schemes* with all intertrips assumed in service.

### 15.1.7 16.2.1 Oscillation damping

- (a) All electromechanical oscillations resulting from any small or large disturbance in the *power system* shall be well damped and the *power system* shall return to a stable operating state.
- (b) The damping ratio of the oscillations should be at least 0.5. For inter-area oscillation modes, lower damping ratios may be acceptable but the halving *time* of such oscillations should not exceed five seconds.

### 15.1.8 16.2.2 Power system stabilisers

- (b) *Power system* simulation studies may indicate the possibility of insufficient damping on the system, and that the best solution to this problem would be the installation of *power system stabilisers*. These are to be installed on those *Generation Units/generating units* where they will be most effective in improving overall system damping.
- (c) The stabilising circuits shall be responsive and adjustable over a wide range of *frequency* range, which shall include frequencies from 0.1 Hz to 2.5 Hz. The PSS settings shall be optimised to provide maximum damping.

### 15.2 16.3 Voltage stability criteria

#### 15.2.1 16.3.1 Voltage stability limits

- (a) All necessary steps should be taken to ensure that *voltage* collapse does not occur for the most onerous *outage* of a *transmission element* under credible *Generation/generation* schedules under full *load* conditions. It should also be assumed that 3% of the installed capacitors are unavailable. *Voltage* collapse is associated with a deficit of *reactive power*. Adequate reactive *reserves* based on *power system* studies should be provided (see notes below).

Notes:

- (1) The system *load* to be used in studies is the 1 in 10 year probability forecast.
- (2) All *Generation/generation* with the exception of one unit is to be taken as available with none of the MVAR limits to be exceeded.

- (b) *Voltage* stability is a function of the dynamic characteristics of system *loads*. A *power system* at a given operating state and subject to a given disturbance is *voltage* stable if post-disturbance *voltages* at every point on the system reach equilibrium within satisfactory limits. Disturbances may be small or large, and *time* frames may vary from tenths of a second to several hours.
  - (c) *Voltage* instability most commonly results in *voltage* collapse, but may give rise to excessively high *voltage* levels under some conditions.
- (e) Adequate and appropriate *reactive power* compensation shall be provided to ensure that the *power system* is protected against all forms of *voltage*

- instability. This can include the use of shunt and series capacitors and / or
- (d) *reactors, SVCs, synchronous condensers*, etc.

### ~~15.2.2~~16.3.2 Voltage collapse

- (a) A *power system* undergoes *voltage* collapse if post-disturbance *voltages* are below acceptable limits. *Voltage* collapse may be total (blackout) or partial.
- (b) The possibility of an actual *voltage* collapse depends upon the nature of the *load*. If the *load* is stiff (constant power, such as a synchronous motor) the collapse is aggravated. If the *load* is soft, e.g. heating, the power absorbed by the *load* falls off rapidly with *voltage* and the situation is alleviated.

### ~~15.2.3~~16.3.3 Resonance conditions

- (a) *Voltage* oscillations can arise within a *power system* as a result of resonance conditions. Resonance effects are generally caused by a series resonance between a capacitance and an inductance, for example a *capacitor bank* and the inductive reactance of a *transmission line* or *transformer*.
- (b) *Network* resonant frequencies can exist above and below synchronous *frequency* and a latent resonance can be excited by a variety of *network* disturbances (large or small).
- (c) If resonance is excited following a *network* disturbance, then oscillations appearing as *network voltage* amplitude modulations can arise.
- (d) If the damping mode of the *network* at the resonant *frequency* is positive then the *network* will absorb the oscillation. However, if the damping is negative, the oscillations will build up and lead to supersynchronous (>50 Hz) or subsynchronous (<50 Hz) instability.
- (e) If corrective action (typically in the form of *load shedding*) is not taken, then this form of oscillation can lead to extensive damage to *network* and *customer* equipment.
- (f) Locations with a low fault level and a weak electrical *connection* (usually with impedance higher than 1.0 p.u. to the source) are prone to sub-synchronous oscillations or resonance.

### ~~15.2.4~~16.3.4 Transient over-voltages

Transient over-*voltages* can arise from normal switching operations and external influences such as lightning strikes. Surge diverters are used where necessary to ensure that the transient over-*voltage* seen by an item of *network plant* is limited to its rated lightning impulse withstand *voltage* level.

### ~~15.2.5~~16.3.5 Temporary over-voltages

Temporary AC over-*voltages* should not exceed the *time* duration limits given in *Australian Standard AS2926 – 1987* unless specific designs are implemented to ensure the adequacy and integrity of equipment on the *power system*, and that the effects on *loads* have been adequately mitigated.

### ~~15.2.6~~16.3.6 Transient voltage dip criteria (TVD)

After clearing a system fault the *voltage* should not drop below 75% and shall not be below 80% for more than 0.4 seconds during the power swing that follows the fault. The maximum transient *voltage* dip is 25% and the maximum duration of *voltage* dip exceeding 20% is 20 cycles (400ms).

### ~~15.3~~16.4 Frequency stability criteria

(a) The *frequency* stability criterion relates to the recovery times for excursions of the system *frequency* from the steady state limits.

(b) ~~The rate of change of frequency for each of the regulated power systems is defined as:~~

~~Darwin – Katherine ± 4 Hz/ Sec~~

~~Alice Springs ± 4 Hz/ Sec~~

~~Tennant Creek ± 4 Hz/ Sec~~

~~(c)~~(c) To cover for a loss of ~~Generation Facilities~~ *generating system facilities* there are two measures applied to bring back the falling *frequency*:

- (1) *Spinning reserve*; and
- (2) *Under frequency load shedding* (UFLS).

~~(d)~~(d) *Under frequency load shedding* relays are installed at zone *substations* to shed *load* at pre-determined levels of *frequency* at or below 49.25 Hz following loss of a major ~~Generation Unit~~ *generating unit* or its *interconnection*.

~~(e)~~(e) Following loss of ~~Generation Facilities~~ *generating system*, system *frequency*, depending on *spinning reserve* or C-FCAS as applicable in each regulated power system, may still decline to such levels that the UFLS automatic scheme will be used to reduce *network load* in order to help the *frequency* recovery.

~~(f)~~(f) It is a requirement for *power system security* that 75% of the *power system load* at any *time* be available for *disconnection* under:

- (1) The automatic control of *under frequency* relays; and
- (2) Manual or automatic control from *control centres*; and/or
- (3) The automatic control of *undervoltage* relays.

~~(g)~~(g) In some circumstances, it may be necessary to have up to 90% of the *power system load*, or up to 90% of the *load* within a specific part of the *network*, available for automatic *disconnection*. *Power and Water* will advise *Users* if this additional requirement is necessary.

~~(h)~~(h) Special *load shedding* arrangements may be required to be installed to cater for abnormal operating conditions.

~~(i)~~(i) The settings for *under-frequency load shedding* in the various *regions*

~~(j)~~(j) throughout the Northern Territory are given in ~~Table 3~~ *Figure 3* of *this Code*.

## **1617** Quality of supply criteria

- (a) *Quality of supply* criteria regulate the *voltage* and current waveforms in the *network* and criteria are established for the following aspects:

~~network and criteria are established for the following aspects:~~

- (1) *Voltage* fluctuation;
- (2) System *Frequency*;



- (3) Harmonic distortion;
  - (4) *Voltage* unbalance; and
  - (5) *Network reliability*.
- (b) The *networks* are analysed to ensure satisfactory performance, in accordance with the *quality of supply* criteria, whenever a new *User* is *connected* or a complaint from an existing *User* is received.
- (c) The aspects of *quality of supply* that are analysed are:
- (1) *Steady state voltage*;
  - (2) *Voltage* fluctuation; and
  - (3) *Network frequency, on isolated regional networks*.
- (d) Harmonic *voltage* and current and *voltage* unbalance will be analysed depending on the nature of the *load* of the new *User* being *connected*.

#### **16.117.1 Voltage fluctuation criteria**

A *voltage* disturbance is where the *voltage* shape is maintained but the *voltage* magnitude varies and may fall outside the steady state *supply voltage* range set out in clause ~~15.2~~ 15.2 of the *Network Planning Criteria*.

- (a) Short duration *voltage* disturbances with durations of up to one minute are termed *voltage* sags and swells.

~~(e)~~ Short duration *voltage* disturbances generally arise from faults on the *network*  
(b) and may not be able to be economically eliminated.

## ~~16.1.11.1.1 Temporary over-voltages~~

### 17.1.1 Temporary over-voltages

- (a) As a consequence of a *credible contingency event*, the *voltage of supply* at a *connection point* should not rise above its *normal voltage* by more than a given percentage of *normal voltage* for longer than the corresponding period shown in ~~Figure 4~~ [Figure 18](#) for that percentage.

**Figure 4** ~~18~~ – Over voltage limit for contingency events

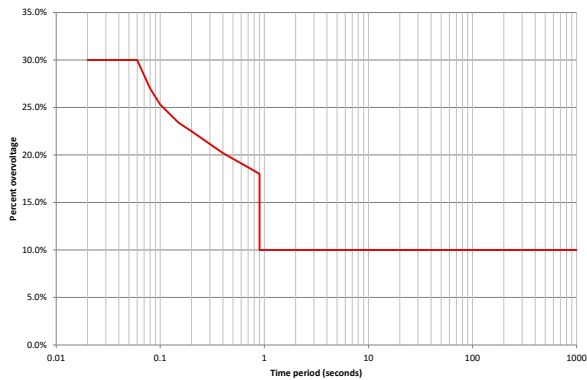
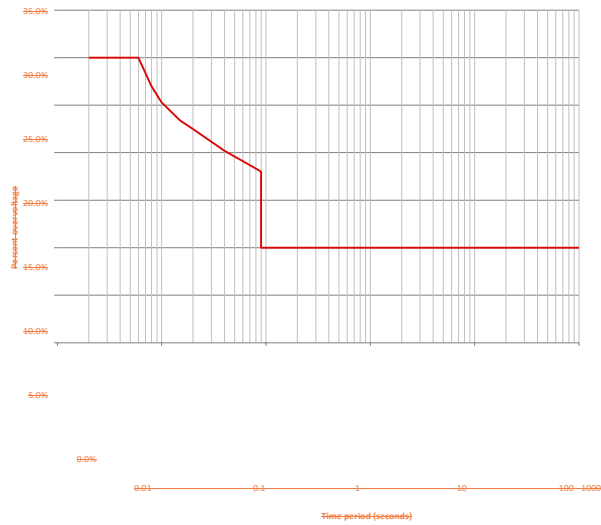

- (b) *Users' equipment* shall also be designed to withstand these *voltage* levels.

- (a) As a consequence of a *contingency event*, the *voltage of supply* at a  
(c) *connection point* could fall to zero for any period.

#### ~~16.1.21.1.1~~ **Step changes in voltage levels**

#### **17.1.2** ~~Step changes in the power system voltage levels may take place due to switching operations on the network.~~ **Step changes in voltage levels**

- (a) Step changes in the *power system voltage* levels may take place due to switching operations on the *network*. The *step changes in voltage* shall not exceed the limits set out in ~~Table 17~~Figure 19~~Figure 19~~.

Table 17 Figure 19 – Step change voltage limits

Cause	Pre-tap-changing		Post-tap-changing (final steady state)	
	≥ 66 kV	< 66 kV	≥ 66 kV	< 66 kV
Routine Switching (1)	±4.0% (max)	±4.0% (max)	Network voltages shall be between 110% and 90% of nominal voltage	Should attain previous set point
Infrequent Switching (2)	+6%, -10% (max)	+6%, -10% (max)	±10% (max)	Should attain previous set point
Notes: 1 For example, capacitor switching, transformer tap action, motor starting, start-up and shutdown of Generation Units. 2 For example, tripping of Generation Units, loads, lines and other components.				
Cause	Pre-tap-changing		Post-tap-changing (final steady state)	
	≥ 66 kV	< 66 kV	≥ 66 kV	< 66 kV
Routine Switching (1)	±4.0% (max)	±4.0% (max)	Network voltages shall be between 110% and 90% of nominal voltage	Should attain previous set point
Infrequent Switching (2)	+6%, -10% (max)	+6%, -10% (max)	±10% (max)	Should attain previous set point
Notes: 1 For example, capacitor switching, transformer tap action, motor starting, start-up and shutdown of generating units. 2 For example, tripping of generating units, loads, lines and other components.				

- (b) Voltage fluctuation severity is characterised by the following two quantities, which are defined in Australian Standard AS/NZS 61000.3.7 (2001):
- (1)  $P_{st}$  - short-term flicker severity term (obtained for each 10 minute period); and
  - (2)  $P_{lt}$  - long-term flicker severity (obtained from 12 consecutive  $P_{st}$  periods for each 2 hour period).
- (c) Under normal operating conditions, flicker severity caused by voltage fluctuation in the transmission and network shall be within the planning levels shown in Table 18 Figure 20 for 99% of the time.

Table 18 Figure 20 – Flicker severity – planning levels

Flicker Severity Quantity	LV 230/400 V	MV (11-66 kV)	HV (132 kV)
P <sub>st</sub>	1.0	0.9	0.8
P <sub>lt</sub>	0.7	0.7	0.6
Notes:			
<ol style="list-style-type: none"> <li>1. These values were chosen on the assumption that the transfer coefficients between MV or HV systems and LV systems are unity. The planning levels could be increased in accordance with AS61000.3.7 (2001).</li> <li>2. The planning levels in this Table are not intended to apply to flicker arising from contingency and other uncontrollable events in the <i>power system</i>, etc.</li> </ol>			

- (d) *Voltage* fluctuations for individual *Users* shall be measured at the point of Common Coupling, which is the point of *connection* to other *Users* in the same portion of the *network*.

## 16.217.2 Harmonic voltage and current distortion

- (a) Power and Water's power networks and all plant and equipment connected thereto shall be planned and designed to ensure that harmonic voltages and currents do not exceed the limits defined in Australian Standard AS/NZS 61000.3.6 (2001).
- (b) For planning purposes the harmonic voltage levels shown in Table 19-Figure 21 apply to the respective system voltage level.

Table 19-Figure 21 - Harmonic voltage distortion limits – planning levels

Order h	Odd harmonics non multiple of 3		Odd harmonics multiple of 3			Even harmonics		
	Harmonic voltage %		Order h	Harmonic voltage %		Order h	Harmonic voltage %	
	LV	≥11-kV		LV	≥11-kV		LV	≥11-kV
5	5.0	2.0	3	4.0	2.0	2	1.6	1.5
7	4.0	2.0	9	1.2	1.0	4	1.0	1.0
11	3.1	1.5	15	0.3	0.3	6	0.5	0.5
13	2.5	1.5	21	0.2	0.2	8	0.4	0.4
17	1.6	1.0	>21	0.2	0.2	10	0.4	0.4
19	1.2	1.0				12	0.2	0.2
23	1.2	0.7				>12	0.2	0.2
25	1.2	0.7						
>25	$0.2 + 0.5 \frac{25}{h}$							

Notes to Table 19-Figure 21:

- This Table is derived from Australian Standard AS/NZS 61000.3.6 (2001).
- The total harmonic distortion ( $U_t$ ) is calculated from the expression

$$U_t = \frac{U_{nom}}{U_1} \sqrt{\sum_{h=2}^{40} (U_h)^2}$$

$$U_t = \frac{U_{nom}}{U_1} \sqrt{\sum_{h=2}^{40} (U_h)^2}$$

Where:

- $U_{nom}$  - nominal voltage of a system
  - $U_1$  - fundamental voltage
  - $U_h$  - harmonic voltage of order h expressed as a percentage of the nominal voltage.
- The harmonic distortion limits apply to each phase.

4. Intermittent harmonic *voltage* distortion is subject to the same limits as continuous harmonic *voltage* distortion.

5. Existing (background) levels of harmonic *voltage* distortion are not included when assessing the harmonic contribution.

### ~~16.2.1~~ ~~17.2.1~~ ~~1.1~~ Inter-harmonic distortion

Inter-harmonic or non-integer harmonic distortion may arise from large converters or power electronics equipment with Pulse Width Modulation (PWM) converters interfacing with the power system.

Inter-harmonic or non-integer harmonic distortion may arise from large converters or power electronics equipment with Pulse Width Modulation (PWM) converters interfacing with the power system.

A *User's* inter-harmonic *voltage* distortion contribution shall not exceed the planning level of 0.2% specified in section 9 of *Australian Standard AS/NZS 61000.3.6:2001*.

### 17.2.2 Direct current

#### ~~16.2.1.11.1.1.1~~ Direct current

- (a) *Plant* and equipment shall comply with the requirements on direct current components as stipulated in clause 3.12 of *Australian Standard AS 3100*. In particular, the direct current in the neutral caused by the *User's plant* and equipment shall not exceed 120mAh per day.
- (b) The responsibility of the *Network Operator* for direct current in the neutral outside the limits specified in this clause shall be limited to direct current in the neutral caused by *network* assets.
- (c) *Plant* and equipment at *Users'* premises shall perform to the standards specified in subclause (a).

### ~~16.3~~ ~~17.3~~ Voltage unbalance

- (a) For normal system operation and for planned system *outages*, the *voltage* unbalance at each of *connection points* to the *network* shall not exceed the limits set out in clause ~~2.4.3~~ ~~2.4.3~~ of the *Code*.
- (b) The responsibility of *Power and Water* for *voltage* unbalance outside the limits specified in clause ~~17.3~~ ~~17.3~~ (a) shall be limited to *voltage* unbalance caused by *network* assets.
- (c) *Users'* equipment shall perform to the standards specified in clause ~~17.3~~ ~~17.3~~ (a).

#### ~~16.3.1.11.1.1.1~~ Electromagnetic interference

### 17.4 Electromagnetic interference

*Power and Water* shall design its *networks* to ensure that the electromagnetic interference caused by its *plant* and equipment does not exceed the limits set out in Tables 1 and 2 of *Australian Standard AS 2344*.



## 1718 Construction standards criteria

- (a) *Power and Water* shall construct the overhead portions of its *networks* in accordance with the Electricity Supply Association of Australia publication C(b)1 -"Guidelines for Design and Maintenance of Overhead Distribution and Transmission lines".

- (b) *Power and Water* shall construct the underground portions of its *networks* in accordance with the Electricity Supply Association of Australia publication C(b)2 - "Guide to the Installation of Cables Underground".

#### **17.118.1 Conductor selection criteria**

- (a) *Power and Water* generally uses overhead conductors for *transmission* and sub-*transmission* circuits in order to minimise construction costs. *Power and Water* may use underground cables for such circuits where required by environmental *constraints* and where the additional cost can be justified.
- (b) *Power and Water* uses underground cables for *distribution network* reinforcement and *extension* within the Darwin Metropolitan area, *Regional Centres*, new sub-divisions where in *Power and Water's* opinion they are appropriate, or if required by legislation. Outside these areas *Power and Water* will generally install overhead conductors.
- (c) In designing *extensions* to the *network*, ultimate *load* horizon planning shall be used to establish the *network* concept plan and the initial installation shall conform to that concept plan and use carriers that are appropriately sized. This methodology eliminates the need to disrupt the community in future years as *load* growth occurs and results in the minimum lifetime cost to the community.
- (d) To achieve maximum cost efficiency in the installation of conductors, standard overhead conductor and underground cable sizes have been selected. This results in minimum stock holdings and purchase prices, giving the *User* the least cost *network*.
- (e) The standard conductor size that is equal to, or greater than that required for the reasonably foreseeable *load*, shall be used for each overhead *network extension* or reinforcement.
- (f) The standard cable size that is equal to, or greater than that required for the horizon *load*, shall be used for each underground *network extension* or reinforcement.

## 18.19 Environmental criteria

<p><i>Power and Water's</i> environmental policy states that:</p> <p><i>"Power and Water</i> recognises and accepts its environmental responsibilities arising from the provision of power, water and sewerage services.</p> <p><i>"Power and Water</i> will seek to minimise environmental impacts and comply with environmental regulations.</p> <p><i>"Continual improvement in environmental performance will be sought by Power and Water</i> through:</p> <ul style="list-style-type: none"><li>• Implementing a comprehensive Environmental Management System;</li><li>• Minimising the environmental impacts of its operations;</li><li>• Promoting individual ownership of environmental care among its people; and</li><li>• Consulting with the community on environmental issues.</li></ul> <p><i>"Sustainable Development will be pursued by Power and Water</i> through:</p> <ul style="list-style-type: none"><li>• Adoption of integrated resource planning;</li><li>• Use of renewable resources;</li><li>• Maximisation of long term benefits from non-renewable resources; and</li><li>• Promotion and adoption of waste minimisation and recycling practices."<p><i>Power and Water</i> commits to the following objectives to fulfil its environmental policy:</p><ul style="list-style-type: none"><li>• To consult openly and fully with the community and government where Authority activity may affect the environment;</li><li>• To ensure that planning and design for new projects and <i>changes</i> to existing processes provide for consideration of best environmental practice technology and <i>timely</i> impact assessment; and</li><li>• To carry out its business in a resource efficient manner.</li></ul><p><i>Power and Water's</i> power networks will be developed so that these <i>commitments</i> are met.</p></li></ul>
---

### 18.19.1 Social issues

*Power and Water* shall inform and consult with relevant public bodies and community interest groups and the general public on the planning of new developments and *facilities*.

### 18.219.2 Electromagnetic fields

Recognising the current state of scientific uncertainty regarding adverse health effects from exposure to power *frequency* electric and magnetic fields, *Power and*

*Power and Water* shall act prudently and design, construct and operate all equipment and *facilities* to maintain electromagnetic field exposure to the public and *Power and Water* employees at levels within the Interim Guidelines on Limits of Exposure to 50/60 Hz Electric and Magnetic Fields set out in the ARPANSA Radiation Health Series No. 30 standard.

### **18.319.3 Land-Use considerations**

*Power and Water* shall avoid, or minimise damage to natural, cultural and historical sites where reasonable and economically practical, consistent with the safe and *reliable* operation of the electricity *supply network*.

### **18.419.4 Noise**

*Power and Water* shall comply with the noise limit provisions of ~~the~~relevant guidelines made under the *Waste Management and Pollution Control Act*.

~~*Environmental Protection Act*~~.

### **18.519.5 Visual amenity**

Given that the community and *customers* are sensitive to the visual impact of electrical installations, *Power and Water* shall conduct its electricity *supply* operations in a manner that minimises visual impact.

## Part D Attachments

### Attachment 1 Glossary of Terms

In this Code, unless the contrary intention appears:

- (a) A word or phrase set out in column 1 of the table below has the meaning set out opposite that word or phrase in column 2 of the table below; ~~and~~
- (b) A word or phrase defined in the *Power and Water Corporation Act* has the meaning given in that Act unless redefined in the table below; ~~and~~
- (c) An italicised word or phrase defined in the NT NER has the meaning given in the NT NER unless redefined in the table below.

Terminology	Definition
<del><i>Access Agreement</i></del>	<del>Means a contract or agreement for the provision of network access services entered into between a network provider and a network User under the Code, and includes an award made by an arbitrator for the same purpose.</del>
<del><i>Access Applicant</i></del>	<del>An existing or new network User making an Access Application under clause 10 of the Electricity Networks (Third Party Access) Code.</del>
<i>Access Application</i>	An <del>Access Application</del> "access application" made under clause 10 of the <del>Electricity Networks (Third Party Access) Code, which is described in Attachment 6 or a connection application or application to connect made under Chapter 5 or Chapter 5A of the NT NER.</del>
<i>access services</i>	The following services: <i>use of system services; common services; connection services and ancillary services.</i>
<i>active energy</i>	A measure of electrical energy flow, being the <i>time</i> integral of the product of <i>voltage</i> and the in-phase component of current flow across a <i>connection point</i> , expressed in Watt-hours (Wh) and multiples thereof.
<i>active power</i>	The rate at which <i>active energy</i> is transferred.
<i>active power capability</i>	The maximum rate at which <i>active energy</i> may be transferred from a <del>Generation Unit</del> <u>generating unit</u> to a <i>connection point</i> as specified in an <i>Access Agreement</i> .
<i>active unit protection</i>	Generally, a <i>protection scheme</i> that compares the conditions at defined <i>primary plant</i> boundaries and can positively identify whether a fault is internal or external to the protected <i>plant</i> . <i>Unit protection schemes</i> can provide high speed (less than 150 milliseconds) <i>protection</i> for the protected <i>primary plant</i> . Generally, <i>unit protection schemes</i> will not be capable of providing back up <i>protection</i> .
<u><i>adverse system strength impact</i></u>	<u>An adverse impact, assessed in accordance with the system strength impact assessment guidelines, on the ability under different operating conditions of:</u>

Terminology	Definition
	<p>(a) the <i>power system</i> to maintain system stability; or            (b) a <i>generating system</i> forming part of the <i>power system</i> to maintain stable operation including, but not limited to following any <i>credible contingency event</i>,            so as to maintain the <i>power system</i> in a <i>secure operating state</i>.</p>
<b>agreed capability</b>	In relation to a <i>connection point</i> , the capability to receive or send out <i>active power</i> and <i>reactive power</i> for that <i>connection point</i> determined in accordance with the relevant <i>Access Agreement</i> .
<b>ancillary services</b>	The following services: <i>voltage control</i> , <i>reactive power control</i> , <i>frequency control</i> , <i>control system services</i> , <i>spinning reserve</i> and <i>post-trip management</i> .
<b>ancillary services agreement</b>	An agreement covering the provision of <i>ancillary services</i> .
<b><u>associated load</u></b>	<u>A <i>load</i> which is normally supplied by a particular <i>Generator</i> and is associated with that <i>Generator</i> by ownership or some contractual arrangement. The <i>load</i> may be remote from the <i>Generator</i> or on-site.</u>

Terminology	Definition
<b>associated load</b>	A <i>load</i> which is normally supplied by a particular <i>Generator</i> and is associated with that <i>Generator</i> by ownership or some contractual arrangement. The <i>load</i> may be remote from the <i>Generator</i> or on-site.
<b>augment, augmentation</b>	In relation to the <i>electricity network</i> , means to enlarge or expand the capability of the <i>electricity network</i> to accept, transport and deliver electricity.
<b>Australian Standard (AS)</b>	The most recent edition of a standard publication by Standards Australia (Standards Association of Australia).
<b><u>automatic access standard</u></b>	<u>In relation to a technical requirement of access, a standard of performance, identified in clause 3.3.5 of this Code as an automatic access standard for that technical requirement, such that a plant that meets that standard would not be denied access because of that technical requirement.</u>
<b>automatic reclose equipment</b>	In relation to a power line, the equipment which automatically recloses the relevant line's circuit breaker(s) following their opening as a result of the detection of a fault in the power line.
<b>backup protection</b>	A <i>protection</i> intended to supplement the main <i>protection</i> in case the latter should be ineffective, or to deal with faults in those parts of the <i>power system</i> that are not readily included in the operating zone of the main <i>protection</i> .
<b>black start capability</b>	In relation to a <del>Generation Unit</del> <i>generating unit</i> , the ability to start and synchronise <del>without using supply from the power system.</del>
<b>black start-up facilities</b>	The <i>facilities</i> required to provide a <del>Generation Unit</del> <i>generating unit</i> with black start-up capability.
<b>black system</b>	The absence of <i>voltage</i> on all or a significant part of the <i>network</i> following a major <i>supply</i> disruption, affecting one or more <i>power stations</i> and a significant number of <i>customers</i> .
<b>breaker fail protection</b>	In relation to a <i>protection scheme</i> , that part of the <i>protection scheme</i> that protects a <i>User's facilities</i> against the non-operation of a circuit breaker when it is required to open.
<b>busbar</b>	A common <i>connection point</i> in a <i>power station substation</i> or a <i>transmission network substation</i> .
<b>business day</b>	Any <i>day</i> other than a <i>Saturday</i> , <i>Sunday</i> , or <i>day</i> that is a public holiday in the City of Darwin.
<b>capacitor bank, capacitor</b>	A type of static electrical equipment used to generate <i>reactive power</i> and therefore support <i>voltage</i> levels on <i>network</i> elements.
<b>cascading outage</b>	The occurrence of an uncontrollable succession of <i>outages</i> , each of which is initiated by conditions (e.g. instability or <i>overloading</i> ) arising or made worse as a result of the event preceding it.
<b>C-FCAS</b>	<u>Contingency frequency control ancillary services (a subset of FCAS).</u>
<b>change</b>	Includes amendment, alteration, addition or deletion.
<b>check metering installation</b>	<del>A metering installation which may be used as a source of metering data for validation, substitution or account estimation as provided in clause 10 of this Code.</del>

***circuit breaker failure***

A circuit breaker will be deemed to have failed if, having received a trip signal from a *protection scheme*, it fails to interrupt fault current within its design operating *time*.

***Code, Technical Code***

This *Code* called the *Technical Code*.

***Code commencement date***

The date given in clause [1-4-1.4](#) of this *Code*.

***commitment***

The commencement of the process of starting up and *synchronising a generating unit to the power system*.



Terminology	Definition
	<del>a Generation Unit to the power system.</del>
<b>common services</b>	A network service that ensures the integrity of the electricity network and benefits all Users and that cannot be practically be allocated to Users on a locational basis.
<b>complementary</b>	In relation to protection, two protection schemes are said to be complementary when, in combination, they provide dependable clearance of faults on plant within a specified time, but with any single failure to operate of the secondary plant, fault clearance may be delayed until the nature of the fault changes.
<u>confidential information</u>	<u>In relation to a Generator or Network Operator, information which is or has been provided to that Generator or Network Operator under or in connection with the Code and which is stated under the Code or by the Network Operator or by the Utilities Commission to be confidential information or is otherwise confidential or commercially sensitive. It also includes any information which is derived from such information.</u>
<b>connect, connection</b>	Means to establish an effective link via installation of the necessary connection equipment.
<u>connection agreement</u>	<u>Means an agreement between a network provider and a Network User which permits a person to connect plant or premises to the network. It includes an agreement for the provision of network access services entered into network provider whether under the former Network Access Code, or under applicable provisions of the NT NER.</u>
<b>connection asset</b>	Means all of the electrical equipment that is used only in order to transfer electricity to or from the electricity network at the relevant connection point and includes any transformers or switchgear at the relevant point or which is installed to support or to provide backup to such electrical equipment as are necessary for that transfer.
<b>connection point</b>	A point at which electricity is transferred to or from an electricity network.
<b>connection services</b>	In relation to a connection point, means the establishment and maintenance of that connection point.
<b>constraint, constrained</b>	A limitation on the capability of a network, load or a <del>Unit</del> <b>Generating unit</b> preventing it from either transferring, consuming or generating the level of electrical power which would otherwise be available if the limitation was removed.
<del>contingency capacity reserve</del> <u>frequency control ancillary services</u>	<del>Actual active and reactive energy capacity, interruptible load arrangements and other arrangements organised to be available to be utilised on the actual occurrence of one or more contingency events to allow the restoration and maintenance of power system security. Services to correct the generation / demand balance following a major contingency event such as the loss of a generating unit, major industrial load, or a large transmission element.</del>
<b>contingency event</b>	An event affecting the power system which the Network Operator expects would be likely to involve the failure or removal from

operational service of a ~~Generation Unit~~*generating unit* or *network* element.

**continuous uninterrupted operation**

In respect of a *generating system* or *generating unit* operating immediately prior to a *power system* disturbance:

- (a) not disconnecting from the *power system* except under its performance standards established under clauses 3.3.5.8 and 3.3.5.9;
- (b) during the disturbance contributing active and reactive current as required by its performance standards established under clause 3.3.5.5;
- (c) after clearance of any electrical fault that caused the disturbance, only substantially varying its active power and reactive power as required or permitted by its performance standards established under clauses 3.3.5.5, 3.3.5.11, 3.3.5.13 and 3.3.5.14; and
- (d) not exacerbating or prolonging the disturbance or causing a subsequent disturbance for other *connected plant*, except as required or permitted by its performance standards, with all essential auxiliary and *reactive plant* remaining in service.

**control centre**

The *facility* used by the *Power System Controller* for directing the minute to minute operation of the *power system*.

**controller**

A person employed by a *Power System Controller* engaged in the activities of controlling the transfer of electrical *energy* at a *connection point*.

**control system**

Means of monitoring and controlling the operation of the *power system* or equipment including ~~Generation Units~~*generating units* connected to a *network*.

**control system services**

The 24-hour control of the *power system* through monitoring, switching and *dispatch* which is provided through *control centres* and SCADA and communication equipment.

Terminology	Definition
<b>credible contingency event</b>	A <i>contingency event</i> the occurrence of which the <i>Network Operator</i> <i>System Controller</i> considers to be reasonably possible in the surrounding circumstances.
<b>critical fault clearance time</b>	Refers to the maximum <i>total fault clearance time</i> that the <i>power system</i> can withstand without one or both of the following conditions arising: <ul style="list-style-type: none"> <li>• Instability (refer to clause 2-62.6); and</li> <li>• Unacceptable disturbance of <i>power system voltage</i> or <i>frequency</i>.</li> </ul>
<b>critical single credible contingency event</b>	A single <i>credible contingency event</i> considered by the <i>Network Operator</i> , in particular circumstances, to have the potential for the most significant impact on the <i>power system</i> at that <i>time</i> . This would generally be the instantaneous loss of the largest <i>Generation Unit</i> <i>generating unit</i> or a fault on a <i>network</i> element on the <i>power system</i> . However, this may involve the consideration by the <i>Network Operator</i> of the impact of the loss of any <i>interconnection</i> under abnormal conditions.
<b>credible contingency</b>	An individual <i>credible contingency event</i> for which a <i>User</i> adversely affected by the event would reasonably expect, under normal conditions, the design or operation of the relevant part of the meshed <i>power system</i> would adequately cater, so as to avoid significant disruption to <i>power system security</i> .
<b>current rating</b>	The maximum current that may be permitted to flow (under defined conditions) through a power line or other item of equipment that forms part of a <i>power system</i> .
<b>current transformer (CT)</b>	A <i>transformer</i> for use with meters and/or <i>protection</i> devices in which the current in the secondary winding is, within prescribed error limits, proportional to and in phase with the current in the primary winding.
<b>customer</b>	A person who purchases electricity supplied through a <i>network</i> .
<b>day</b>	Unless otherwise specified, the 24 hour period beginning and ending at midnight Australian Central Standard <i>Time</i> .
<b>decommission, decommissioning</b>	In respect of an item of <i>plant</i> or a <i>Generation Unit</i> <i>generating unit</i> , ceasing to operate and being <i>disconnected</i> from a <i>network</i> .
<b>derogation</b>	Modification, variation or exemption to one or more provisions of the <i>Code</i> in relation to a <i>User</i> according to clause 12-012.
<b>de-synchronising/ de-synchronisation</b>	The act of <i>disconnection</i> of a <i>Generation Unit</i> <i>generating unit</i> from the <i>power system</i> , normally under controlled circumstances.
<b>differing principle</b>	Two <i>protection schemes</i> are said to be of <i>differing principle</i> when their functioning is based on different measurement or operating methods, or use similar principles but have been designed and manufactured by different organisations.

Terminology	Definition
<b>direction</b>	A <i>direction</i> issued by the <i>Network Operator</i> or <i>Power System Controller</i> to any <i>User</i> requiring the <i>User</i> to do any act or thing which the <i>Network Operator</i> or <i>Power System Controller</i> considers necessary to maintain or re-establish <i>power system security</i> or to maintain or re- establish the <i>power system</i> in a <i>reliable</i> operating state in accordance with this <i>Code</i> .
<b>disconnection, disconnect, disconnected, disconnecting</b>	In respect of a <i>connection point</i> or item of <i>plant</i> , means to operate switching equipment so as to prevent the transfer of electricity through the <i>connection point</i> or item of <i>plant</i> .
<b>dispatch</b>	The act of committing to service all or part of the <i>Generation</i> <del>generation</del> available from a <i>scheduled Generation Unit</i> <del>generating unit</del> .
<b>distribution system, distribution network</b>	That part or those parts of the <i>electricity network</i> used for transporting electricity at <i>nominal voltages</i> of less than 66 kV and at a <i>nominal frequency</i> of 50Hz.
<b>dynamic performance</b>	The response and behaviour of <i>networks</i> and <i>facilities</i> which are <i>connected</i> to the <i>networks</i> when the normal operating state of the <i>power system</i> is disturbed.
<b>electrical energy loss</b>	<i>Energy loss</i> incurred in the production, transportation and/or use of electricity.
<b>electricity network</b>	The <i>connection assets</i> and <i>network system assets</i> which together are operated by the network provider for the purposes of transporting electricity from <i>Generators</i> of electricity to a transfer point or to consumers of electricity.
<b><u>Electricity Reform Act</u></b>	<u>The Electricity Reform Act 2000 (NT)</u>
<b><u>Electricity Reform (Administration) Regulations</u></b>	<u>Electricity Reform (Administration) Regulations 2000 (NT)</u>
<b>electricity transmission capacity</b>	The capacity of the <i>transmission network</i> to transmit power between two or more points under the full range of operating conditions likely to be experienced in service.
<b>embedded Generator</b>	A <i>Generator</i> which supplies on-site <i>loads</i> or <i>distribution network loads</i> and is <i>connected</i> either indirectly (i.e. via the <i>distribution network</i> ) or directly to the <i>transmission network</i> .
<b>energise/energisation</b>	The act of operation of switching equipment or the start-up of a <i>Generation Unit</i> <del>generating unit</del> , which results in there being a non-zero <i>voltage</i> beyond a <i>connection point</i> or part of the <i>network</i> .
<b>energy</b>	<i>Active energy</i> and/or <i>reactive energy</i> .
<b>energy data</b>	<del>The data that results from the measurement of the flow of electricity in a power conductor. The measurement is carried out at a metering point.</del>
<b>excitation control system</b>	In relation to a <i>Generation Unit</i> <del>generating unit</del> , the automatic control system that provides the field excitation for the <i>Generator</i> of a <i>Generation Unit</i> <del>generating unit</del> (including excitation limiting devices and any <i>power system stabiliser</i> ).
<b><u>Existing Connection Plant</u></b>	<u>Has the meaning given in clause 12.2.</u>

**extension**

The capital investment associated with the designing, constructing, installing and commissioning of the *electricity network* assets required to *connect* a *User* to the *electricity network*.

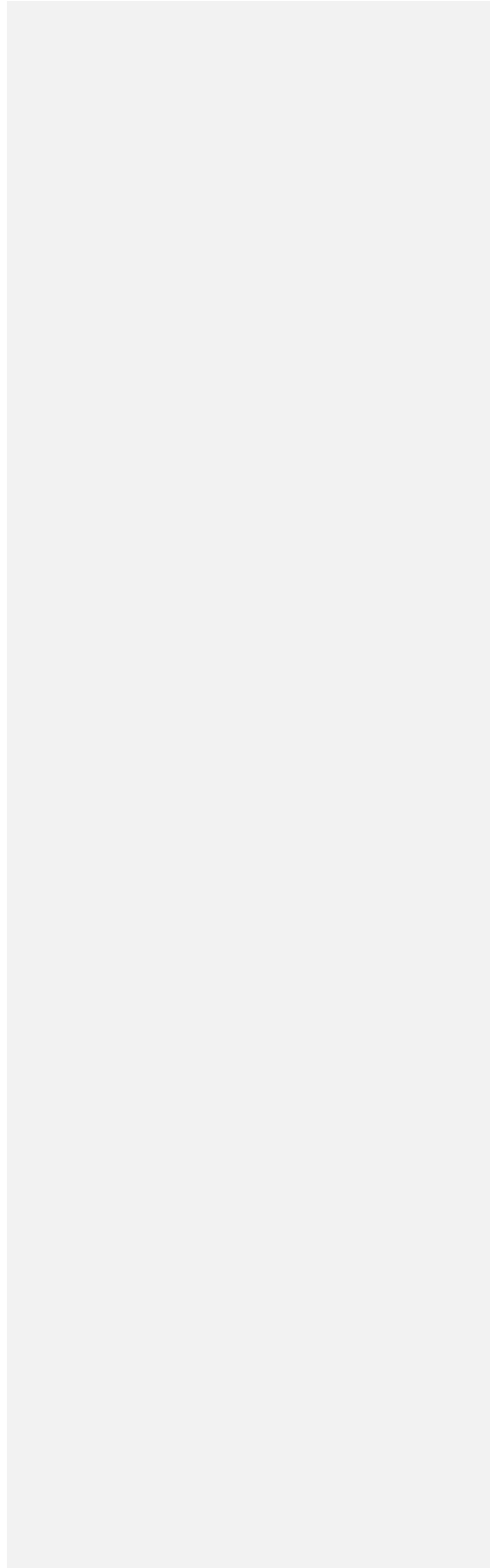

Terminology	Definition
<b>facility, facilities</b>	A generic term associated with the apparatus, equipment, buildings and necessary associated supporting resources provided at, typically: <ul style="list-style-type: none"> <li>• a power station or <del>Generation Unit</del> <u>generating unit</u>, including start-up facilities;</li> <li>• a substation or power station substation;</li> <li>• a control centre.</li> </ul>
<b>fault clearance time</b>	The time interval between the occurrence of a fault and the fault clearance.
<b>FCAS</b>	<u>Frequency control ancillary services</u>
<b>financial year</b>	A period commencing on 1 September in one calendar year and terminating on 30 June in the following calendar year.
<b>frequency</b>	For alternating current electricity, the number of cycles occurring in each second. The term Hertz (Hz) corresponds to cycles per second.
<b>frequency control ancillary services</b>	<u>The suite of services used by the Power System Controller to maintain the frequency on the electrical system, at any point in time, close to fifty cycles per second as required by the NT frequency standards.</u>
<b>frequency operating standards</b>	The frequency standards set out in clauses 2.2, and 2.4 of this Code.
<b>frequency response mode</b>	The mode of operation of a <del>Generation Unit</del> <u>generating unit</u> which allows automatic changes to the generated power when the frequency of the power system changes.
<b>generated</b>	In relation to a <del>Generation Unit</del> <u>generating unit</u> , the amount of electrical energy produced by the <del>Generation Unit</del> <u>generating unit</u> as measured at its terminals.
<b>Generating System</b> <del>generating system</del>	<u>A system comprising one or more <del>Generation Units</del> <u>generating units</u> and that includes auxiliary or reactive plant that is located on the Generator's side of the connection point and is necessary for the <u>generating system</u> to meet its performance <del>standards</del> <u>obligations</u>.</u>
<b>Generator, Generation Unit, Facilities</b> <del>generating unit</del>	<del>A</del> <u>The plant used in the production of electricity generator, and all related equipment essential to the generator's operation, which supplies electricity into an electricity network and together function its functioning</u> as a single entity.
<b>Generation</b> <del>generation</del>	The production of electrical energy by converting another form of energy in a <del>Generation Unit</del> <u>generating unit</u> .
<b>generation centre</b>	A geographically concentrated area containing a <del>Generation Unit</del> <u>generating unit</u> or <del>Generation Units</del> <u>generating units</u> with significant combined generating capability.

Terminology	Definition
<b><u>Generator</u></b>	<u>A person who engages in the activity of owning, controlling or operating a generating system that is connected to a Network and, in respect of a generating system connected to the Darwin-Katherine power system, is either registered by the Market Operator as a Generator or, intends to register with the Market Operator as a Generator.</u>
<b>Generator User</b>	A person who has been granted access to the electricity network by the network provider and who supplies electricity into the electricity network at an entry point.
<b>good electricity industry practice</b>	The exercise of that degree of skill, diligence, prudence and foresight that reasonably would be expected from a significant proportion of operators of facilities forming part of a power system for the <del>Generation</del> generation, transmission distribution and supply of electricity comparable to those applicable to the relevant facility consistent with applicable laws, the Access Code, the Technical Code, licences, industry Codes, reliability, safety and environmental protection.
<b>governor system</b>	The automatic control system which regulates the speed and power output of a <del>Generation Unit</del> generating unit through the control of the rate of entry into the <del>Generation Unit</del> generating unit of the primary energy input (for example, steam, gas or water).
<b><u>inertia</u></b>	<u>Contribution to the capability of the power system to resist changes in frequency by means of an inertial response from a generating unit, network element or other equipment that is electro-magnetically coupled with the power system and synchronised to the frequency of the power system.</u>
<b><u>inertia FCAS</u></b>	<u>Inertia frequency control ancillary services (a subset of FCAS).</u>
<b><u>Inertia frequency control ancillary services</u></b>	<u>Services that contribute to the capability of the power system to resist changes in frequency by means of an inertial response from a generating unit, network element or other equipment that is electro-magnetically coupled with the power system and synchronised to the frequency of the power system.</u>
<b>instrument transformer</b>	Either a current transformer (CT) or a voltage transformer (VT).

Terminology	Definition
<b>interconnection, interconnector, interconnect, interconnected</b>	A <i>transmission line</i> or group of <i>transmission lines</i> that connects the <i>transmission networks</i> in adjacent <i>regions</i> .
<b>interruptible load</b>	A <i>load</i> which is able to be <i>disconnected</i> , either manually or automatically initiated, which is provided for the restoration or control of the <i>power system frequency</i> by the <i>Power System Controller</i> to cater for <i>contingency events</i> or shortages of <i>supply</i> .
<b>intra-regional</b>	Within a <i>region</i> .
<b>Large Generator</b>	A <i>Generator</i> that is not a <i>Small Generator</i> .
<b>large network investment</b>	A proposed investment in augmentation of the <i>network</i> or a non- <i>network</i> alternative with a capitalised net present value in excess of \$5 Million.
<b>load, loading</b>	The amount of electrical <i>energy</i> delivered at a defined instant at a <i>connection point</i> or aggregated over a group of <i>connection points</i> .
<b>load centre</b>	A geographically concentrated area containing <i>load</i> or <i>loads</i> with a significant combined consumption capability.
<b>load shedding</b>	Reducing or <i>disconnecting load</i> from the <i>power system</i> . (See also <i>under frequency load shedding, under voltage load shedding</i> ).
<b>local black system procedures</b>	The procedures, described under clause <a href="#">4.7.9-4.7</a> applicable to a <i>User</i> as procedures approved by the <i>Power System Controller</i> from <i>time to time</i> .
<b>low voltage (LV)</b>	That portion of the <i>network</i> and <i>connections</i> to it operating at a <i>nominal voltage</i> of 230 volts single phase or 400 volts three phase.
<b><u>Market Operator</u></b>	<a href="#">A function of the Power System Controller pursuant to the Electricity Reform Act and Electricity Reform (Administration) Regulations.</a>
<b>maximum fault current</b>	The current that will flow to a fault on an item of <i>plant</i> when <i>maximum system conditions</i> prevail.
<b>maximum system conditions</b>	For any particular location in the <i>power system, maximum system conditions</i> are those which will prevail with the maximum number of <i>Generators</i> and <i>network</i> elements normally <i>connected</i> at <i>times</i> of maximum <a href="#">Generationgeneration</a> .
<b>meter, metering, metering equipment</b>	Equipment used to measure and record the rate at which electricity is transferred and the quantity of electricity transferred to and from the <i>network</i> .
<b>minimum fault current</b>	The current that will flow to a fault on an item of <i>plant</i> when present <i>day minimum system conditions</i> prevail.
<b>minimum system conditions</b>	For any particular location in the <i>power system, minimum system conditions</i> are those which will prevail with the least number of <i>Generators</i> and <i>network</i> elements normally <i>connected</i> at <i>times</i> of minimum <a href="#">Generationgeneration</a> , in combination with one <i>primary plant outage</i> . The <i>primary plant outage</i> shall be taken to be that which, in combination with the minimum <a href="#">Generationgeneration</a> ,



***monitoring equipment***

leads to the lowest fault current at the particular location for the fault type under consideration.

The testing instruments and devices used to record the performance of *plant* for comparison with expected performance.

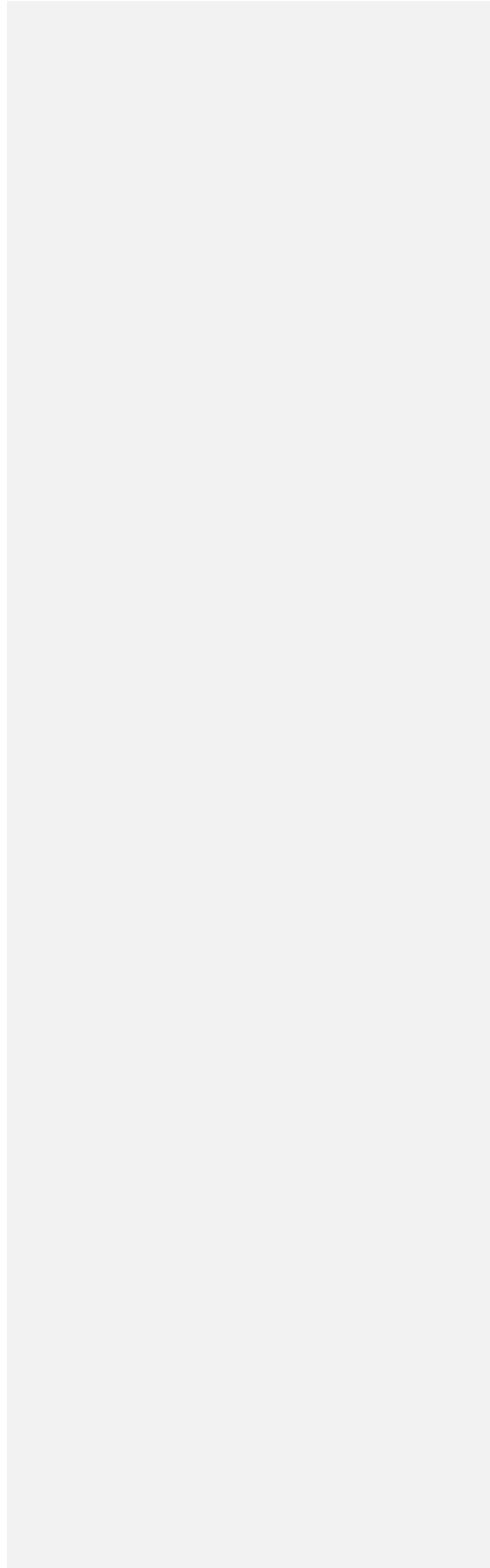

Terminology	Definition
<b>month</b>	Unless otherwise specified, the period beginning at 12.00 am on the “relevant commencement date” and ending at 12.00 am on the date in the “next calendar <i>month</i> ” corresponding to the commencement date of the period. If the “relevant commencement date” is the 29th, 30th or 31st and this date does not exist in the “next calendar <i>month</i> ”, then the end date in the “next calendar <i>month</i> ” shall be taken as the last <i>day</i> of that <i>month</i> .
<b>nameplate rating</b>	The maximum continuous output or consumption in MW or MVA of an item of equipment as specified by the manufacturer.
<b>NATA</b>	National Association of Testing Authorities.
<b>network</b>	See definition for <i>electricity network</i> .
<b><u>negotiated access standard</u></b>	<u>In relation to a technical requirement of access for a particular plant, an agreed standard of performance determined in accordance with this Code and identified as a negotiated access standard for that technical requirement in a connection agreement.</u>
<b>Network Access Code</b>	<u>The Northern Territory Electricity Networks (Third Party Access) Code that was established under Part 2 of the Northern Territory Electricity Networks (Third Party Access) Act (now repealed).</u>
<b>network capability</b>	The capability of the <i>network</i> or part of the <i>network</i> to transfer electrical <i>energy</i> from one location to another.
<b>network losses</b>	The <i>energy</i> loss incurred in the transportation of electricity from an entry or transfer point to an exit point or another transfer point on an <i>electricity network</i> .
<b>Network Management Plan</b>	A report prepared and published annually by the <i>Network Operator</i> . Amongst other things, this report contains the following details: <ul style="list-style-type: none"> <li>• network limitations;</li> <li>• potential non-network and network solutions for small network investments; and</li> <li>• potential non-network and network solutions for large network investments.</li> </ul>
<b>Network Operator</b>	A <del>body</del> person defined as a “network provider” <del>in under section 4(1) of the Electricity Networks (Third Party Access) Reform Act as in force at 1 February 2011. The Network Operator provides access services in respect of Power and Water’s electricity network. July 2019.</del>
<b><u>Network Operator’s metering manuals</u></b>	<u>Specifications prepared by the Network Operator for equipment including revenue metering and communications enclosures, indoor and outdoor revenue metering units (VTs and CTs plus enclosure), CTs, VTs, marshalling boxes and wiring.</u>
<b>Network Planning Criteria</b>	Criteria consistent with this <i>Code</i> prepared by the <i>Network Operator</i> which include the following: contingency criteria; steady-state criteria; stability criteria (transient, dynamic, <i>voltage</i> , and <i>frequency</i> ); <i>quality of supply</i> criteria ( <i>voltage</i> limits, <i>voltage</i> fluctuation, system <i>frequency</i> , harmonic <i>voltage</i> , harmonic current,

voltage unbalance, electro-magnetic interference) and environmental criteria.

Network User

Any person or body that has entered into a connection agreement with the Network Operator to convey electricity from an entry point to an exit point.

**nomenclature standards**

The standards approved by the Network Operator relating to numbering, terminology and abbreviations used for information transfer by Users as provided for in ~~clause 4.9~~clause 4.9.

**non-credible contingency event**

A contingency event other than a credible contingency event. It means a contingency event in relation to which, in the circumstances, the probability of occurrence is considered by the System Controller to be very low.

normal operating frequency band

In relation to the frequency of the power system, means the range specified in clause 2.2.1.

normal operating frequency excursion band

In relation to the frequency of the power system, means the range specified as being acceptable for infrequent and momentary excursions of frequency outside the normal operating frequency band being the range specified in clause 2.2.1.

nominal voltage

The design voltage level, nominated for a particular location on the power system, such that power lines and circuits that are electrically connected other than through transformers have the same nominal voltage regardless of operating voltage.

normal voltage

In respect of a connection point, its nominal voltage or such other voltage up to 10% higher or lower than nominal voltage, as approved by the ~~System~~Network Operator, for that connection point, ~~at the request of the Network Operator who provides connection to the power system.~~

NT NER

The National Electricity Rules as applicable in the Northern Territory.

operational communication

A communication concerning the arrangements for, or actual operation of the power system in accordance with the Code.

operational frequency tolerance band

The range of frequency within which the power system is to be operated under abnormal operating conditions as specified in clause 2.2.2 (b).

Terminology	Definition
	<del>Network Operator to be very low.</del>
<b>normal operating frequency band</b>	In relation to the <i>frequency of the power system</i> , means the range specified in clause 2.2.1.
<b>normal operating frequency excursion band</b>	In relation to the <i>frequency of the power system</i> , means the range specified as being acceptable for infrequent and momentary excursions of <i>frequency</i> outside the <i>normal operating frequency band</i> being the range specified in clause 2.2.1.
<b>operational communication</b>	<del>A communication concerning the arrangements for, or actual operation of the power system in accordance with the Code.</del>
<b>outage</b>	Any planned or unplanned full or partial unavailability of <i>plant</i> or equipment.
<b>peak load</b>	Maximum <i>load</i> .
<b>plant</b>	Includes all equipment involved in generating, utilising or transmitting electrical <i>energy</i> .
<b>post-trip management</b>	The maintenance of system security in the aftermath of trips.
<b>Power and Water Corporation</b>	The body corporate established under the <i>Government Owned Corporations Act</i> <del>as in force at 1 February 2011</del> .
<b>Power system security responsibilities</b>	<del>The responsibilities described in clause 4.3.</del>
<b>power factor</b>	The ratio of the <i>active power</i> to the apparent power at a point.
<b>power station</b>	In relation to a <i>Generator</i> , a <i>facility</i> in which any of that <i>Generator's Generation Units</i> <del>generating units</del> are located.
<b>power system</b>	The <del>Generation</del> <i>generation</i> facilities and <i>electricity network facilities</i> which together are integral to the <i>supply</i> of electricity, operated as an integrated arrangement.
<b>Power System Controller</b>	<del>See definition in the Electricity Networks (Third Party Access) Act as in force at 1 February 2011. The power system controller controls the day-to-day dispatch of generators and associated ancillary services and the maintains power system security. The entity licenced by the Utilities Commission pursuant to section 30 of the Electricity Reform Act.</del>
<b>power system operating procedures</b>	The procedures to be followed by <i>Users</i> in carrying out operations and /or maintenance activities on or in relation to primary and <i>secondary equipment</i> connected to or forming part of the <i>power system</i> or <i>connection points</i> , as described in <del>clause 4.6.</del> <u>the System Control Technical Code.</u>
<b>power system security</b>	The safe scheduling, operation and control of the <i>power system</i> on a continuous basis in accordance with the principles set out in <del>clause 4.2.3.</del> <u>the System Control Technical Code.</u>
<b>power system security responsibilities</b>	<u>The responsibilities described in clause 4.3 and in the System Control Technical Code.</u>
<b>power system stabiliser</b>	An auxiliary control device <i>connected</i> to an <i>excitation control system</i> to provide additional feedback signals to reduce <i>power system</i> oscillations.

***power transfer***

The instantaneous rate at which *active energy* is transferred between *connection points*.

***power transfer capability***

The maximum permitted *power transfer* through a *network* or part thereof.

***primary equipment,  
primary plant***

Refers to apparatus which conducts *power system load* or conveys *power system voltage*.

**protection**

Used to describe the concept of detecting, limiting and removing the effects of *primary plant* or *primary equipment* faults from the *power system*. Also used to refer to the apparatus required to achieve this function.

Terminology	Definition
<b>protection</b>	Used to describe the concept of detecting, limiting and removing the effects of <i>primary plant</i> or <i>primary equipment</i> faults from the <i>power system</i> . Also used to refer to the apparatus required to achieve this function.
<b>protection apparatus</b>	Includes all relays, meters, power circuit breakers, <i>synchronisers</i> and other control devices necessary for the proper and safe operation of the <i>power system</i> .
<b>protection scheme</b>	A collection of one or more sets of <i>protection</i> for the purpose of protecting <i>facilities</i> and the <i>electricity network</i> from damage due to an electrical or mechanical fault or due to certain conditions of the <i>power system</i> .
<b>protection system</b>	A system which includes all the <i>protection schemes</i> applied to the system.
<b>quality of supply</b>	Refers to, with respect to electricity, technical attributes to a standard referred to in clause 2.4, unless otherwise stated in this Code or <del>an Access Agreement</del> a <i>connection agreement</i> .
<b>ramp rate</b>	The rate of <i>change</i> of electrical power produced from a <del>Generation Unit</del> <i>generating unit</i> .
<b>rate of change of frequency (ROCOF)</b>	<u>The rate of change of power system frequency.</u>
<b>reactive energy</b>	A measure, in var-hours (VARh) of the alternating <i>exchange</i> of stored <i>energy</i> in inductors and capacitors, which is the <i>time</i> -integral of the product of <i>voltage</i> and the out-of-phase component of current flow across a <i>connection point</i> .
<b>reactive plant</b>	<i>Plant</i> which is normally specifically provided to be capable of providing or absorbing <i>reactive power</i> and includes the <i>plant</i> identified in clause <del>3.6.7-3.6.7</del> .
<b>reactive power</b>	The rate at which <i>reactive energy</i> is transferred. <i>Reactive power</i> is a necessary component of alternating current electrical power which is separate from <i>active power</i> and is predominantly consumed in the creation of magnetic fields in motors and <i>transformers</i> and produced by <i>plant</i> such as: <ul style="list-style-type: none"> <li>• alternating current <i>Generators</i>;</li> <li>• capacitors, including the capacitive effect of power lines; and</li> <li>• <i>synchronous condensers</i>.</li> </ul>
<b>reactive power capability</b>	The maximum rate at which <i>reactive energy</i> may be transferred from a <del>Generation Unit</del> <i>generating unit</i> to a <i>connection point</i> as specified in <del>an Access Agreement</del> a <i>connection agreement</i> .
<b>reactive power reserve</b>	Unutilised sources of <i>reactive power</i> arranged to be available to cater for the possibility of the unavailability of another source of <i>reactive power</i> or increased requirements for <i>reactive power</i> .
<b>reactive power support/ reactive support</b>	The provision of <i>reactive power</i> .
<b>reactor</b>	A device, similar to a <i>transformer</i> , specifically arranged to be connected into the <i>network</i> during periods of low <i>load demand</i> or

low *reactive power demand* to counteract the natural capacitive effects of long *transmission lines* in generating excess *reactive power* and so correct any *voltage effects during these periods*.

Terminology	Definition
<b>reconnection</b>	<del>power and so correct any voltage effects during these periods.</del> In respect of a <i>connection point</i> , means to operate switching equipment so as to restore the transfer of electricity through the <i>connection point</i> .
<b>region, regional</b>	An area determined by the <i>Network Operator</i> , being an area served by a particular part of the <i>transmission network</i> containing one or more major <i>load centres</i> or <i>generation centres</i> or both.
<b>regulating duty</b>	In relation to a <del>Generation Unit</del> <i>generating unit</i> , the duty to have its <i>generated</i> output adjusted frequently so that any <i>power system</i> <i>frequency</i> variations can be corrected.
<u>regulating frequency control ancillary services</u>	<u>Services to correct the generation / demand balance in response to minor deviations in load or generation.</u>
<u>releasable user guide</u>	A document associated with the data and model provided under clause 3.3.4 (combined, forming the model), that contains sufficient information to enable <i>connection applicants</i> for a new or modified <i>generating unit</i> or <i>generating system</i> to use the model to carry out <i>power system studies</i> for planning and operational purposes. The information in a <i>releasable user guide</i> must include, but is not limited to: <ol style="list-style-type: none"> <li>(1) <u>the model parameters and their values;</u></li> <li>(2) <u>information about how the model parameter values vary with the operating state or output level of the <i>plant</i> or with the operating state or output level of any associated <i>plant</i>;</u></li> <li>(3) <u>instructions relevant to the use and operation of the model;</u></li> <li>(4) <u>settings of <i>protection systems</i> that are relevant to load flow or dynamic simulation studies;</u></li> <li>(5) <u>information provided in accordance with other provisions on the NTC only to the extent that the information is not a part of the model or the model parameters and that is reasonably necessary to allow modelling of the <i>generating unit</i>, <i>generating system</i> or related <i>plant</i> in <i>power system</i> load flow or dynamic simulation studies;</u></li> <li>(6) <u><i>connection point</i> details including its parameters and values, location, network augmentations or modifications and other relevant connection information;</u></li> <li>(7) <u>in regards to any relevant <i>generating unit</i> or <i>generating system</i>, the date on which any of the following has occurred or is expected to occur:</u> <ol style="list-style-type: none"> <li>(i) <u>a <i>connection application</i> is made under clause 5.3.4(a) of the NT NER;</u></li> <li>(ii) <u>(ii) a <i>connection agreement</i> is entered into under clause 5.3.7 of the NT NER;</u></li> <li>(iii) <u>the <i>Generator</i> submits a proposal to alter a <i>connected generating system</i> or a <i>generating system</i>, for which <i>performance standards</i> have previously been accepted by the <i>Network Operator</i>, under clause 3.3.5;</u></li> </ol> </li> </ol>



	<p><u>(iv) (iv) the Generator is notified that the Network Operator is satisfied with the proposed alterations to the generating plant under clause 5.3.10 of the NT NER;</u></p> <p><u>(v) connection;</u></p> <p><u>(vi) commencement of commissioning; and</u></p> <p><u>(vii) conclusion of commissioning; and</u></p> <p><u>(8) the date this document was prepared or updated.</u></p>
<b>reliability</b>	The probability of a system, device, <i>plant</i> or equipment performing its function adequately for the period of <i>time</i> intended, under the operating conditions encountered.
<b>reliable</b>	The expression of a recognised degree of confidence in the certainty of an event or action occurring when expected.
<b>remote back up protection</b>	Refers to the detection and initiation of tripping at a location other than that at which the main <i>protection scheme</i> of the faulted <i>plant</i> is located. Remote back up <i>protection</i> provides a means of detecting and initiating clearance of <i>small zone faults</i> or fault contributions supplied via failed circuit breakers.
<b>remote control equipment (RCE),</b>	Equipment installed to enable control or monitoring of a <i>facility</i> from a <i>control centre</i> , including a remote terminal unit (RTU).
<b>remote monitoring equipment (RME)</b>	
<b>representative</b>	In relation to a person, any employee, agent or Consultant of: <p><u>(a) that person; or</u></p> <p><u>(b) a related body corporate of that person; or</u></p> <p><u>(c) a third party contractor to that person.</u></p>
<b>reserve</b>	The <i>active power</i> and <i>reactive power</i> available to the <i>power system</i> at a nominated <i>time</i> but not currently utilised.
<b>revenue meter R-FCAS</b>	<u>A device complying with Australian Standards which measures and records the production or consumption of electrical energy that is used for obtaining the primary source of revenue metering data-Regulating frequency control ancillary services (a subset of FCAS)</u>
<b>revenue metering installation rotating rectifier</b>	<u>A metering installation used for recording the production or consumption of electrical energy-A type of brushless excitation system for a synchronous generating unit.</u>
<b>revenue metering data RTU</b>	<u>The data obtained from a revenue metering installation, the processed data or substituted data-A Remote Terminal Unit</u>
<u>Version 3.1</u>	<u>Page 165 of 188</u> <u>December 2013</u>

<b><i>revenue metering database</i></b>	<u>installed within a substation or generator's facility to enable monitoring and control of a facility from a control centre.</u> A database of <i>revenue metering data</i> .
<b><i>satisfactory operating state revenue metering point</i></b>	The point of physical connection of the device measuring <u>In relation to the power system, has the current meaning given in the power conductor System Control Technical Code.</u>
<b><i>revenue metering register</i></b>	A register of information associated with a <i>revenue metering installation</i> as required by clause 10.2.
<b><i>revenue metering system</i></b>	The collection of all components and arrangements installed or existing between each <i>revenue metering point</i> and the <i>revenue metering database</i> .

Terminology	Definition
<b>RTU</b>	A Remote Terminal Unit installed within a <i>substation</i> or generating station to enable monitoring and control of a <i>facility</i> from a <i>control centre</i> .
<b>satisfactory operating state</b>	In relation to the <i>power system</i> , has the meaning given in clause 4.2.1.
<b>SCADA system</b>	Supervisory control and data acquisition equipment which enables the <i>Power System Controller</i> to continuously and remotely monitor, and to a limited extent control, the import or export of electricity from or to the <i>power system</i> .
<b>scheduled <del>Generation Unit</del> generating unit</b>	A <del>Generation Unit</del> <i>generating unit</i> which is <i>dispatched</i> by the <i>Power System Controller</i> .
<b>secondary equipment, secondary plant</b>	Those assets of a <i>facility</i> and the <i>electricity network</i> which do not carry the <i>energy</i> being traded, but which are required for control, <i>protection</i> or operation of assets that carry such <i>energy</i> .
<b>secondary plant contingency</b>	Any single failure of <i>secondary plant</i> .
<b>secure operating state</b>	In relation to the <i>power system</i> has the meaning given in clause 5.2.2 <u>the System Control Technical Code</u> .
<b>sensitivity</b>	In relation to <i>protection schemes</i> , has the meaning in clause 6.1.6.1-6.1.6.1.
<b>settlements</b>	<del>The activity of producing bills and credit notes for Users.</del>
<b>single contingency</b>	In respect of a <i>network</i> , a sequence of related events which result in the removal from service of one line, <i>transformer</i> or other item of <i>plant</i> . The sequence of events may include the application and clearance of a fault of defined severity.
<b>small network investment</b>	A proposed investment in augmentation of the <i>network</i> or a non- <i>network</i> alternative with a capitalised net present value in excess of \$1 Million that is not a <i>large network investment</i> .
<b>Small Generator</b>	<u>A person who engages in the activity of owning, controlling or operating a small generating system.</u>
<b>Small Generator small generating system</b>	A <del>Generation Unit</del> <i>generating unit</i> or group <del>Generation Units</del> <i>of generating units</i> with: <ul style="list-style-type: none"> <li>(1) aggregate rated capacity of no more than 2 MW or 10% of the minimum <i>demand</i> of an isolated <i>network</i>, whichever is the lesser;</li> <li>(2) connected to the 22-kV, 11-kV or <i>low voltage networks</i>; and</li> <li>(3) not subject to <i>dispatch</i> by the System Operator.</li> </ul>
<b>Small Generation Unit</b>	<u>A generating unit that forms part of a small generating system.</u>
<b>Small Inverter Energy System</b>	A <i>Small Inverter Energy System</i> is a <del>Generation Unit</del> <i>generating unit</i> which uses an inverter that changes its direct-current power to alternating current power acceptable for power system connection. The nominal network voltages and maximum energy system capacities for which these requirements apply are: <ul style="list-style-type: none"> <li>(1) 230 V single phase      10-kVA</li> <li>(2) 400 V three phase      30-kVA</li> </ul>

***small zone fault***

A fault which occurs on an area of *plant* that is within the zone of detection of a *protection scheme*, but for which not all contributions will be cleared by the circuit breaker(s) tripped by that *protection scheme*. For example, a fault in the area of *plant* between a *current transformer* and a circuit breaker, fed from the *current transformer* side, may be a *small zone fault*. \_\_\_\_\_

Terminology	Definition
<b>spare network capacity</b>	The capacity to transport electricity over a particular <i>electricity network</i> which the network provider assesses is in surplus to the capacity that existing end-use <i>customers</i> forecast will be required to satisfy their reasonably foreseeable requirements for the transport of electricity.
<b>spinning reserve</b>	The ability to immediately and automatically increase <i>Generation</i> or reduce <i>demand</i> in response to a fall in <i>frequency</i> .
<b>standby power</b>	The amount of electrical <i>energy</i> which could be supplied to a <i>load User</i> in accordance with the terms of a standby <i>Generation</i> agreement.
<b>static excitation system</b>	An <i>excitation control system</i> in which the power to the rotor of a <i>synchronous Generation Unit</i> is transmitted through high power solid-state electronic devices.
<b>static var compensator</b>	A device specifically provided on a <i>network</i> to provide the ability to generate and absorb <i>reactive power</i> and to respond automatically and rapidly to <i>voltage</i> fluctuations or <i>voltage</i> instability arising from a disturbance or disruption on the <i>network</i> .
<b>sub-network</b>	A particular portion of the <i>network</i> .
<b>substation</b>	A <i>facility</i> at which lines are switched for operational purposes. May include one or more <i>transformers</i> so that some <i>connected</i> lines operate at different <i>nominal voltages</i> to others.
<b>supply, supplying</b>	The delivery of electricity.
<b>synchronise</b>	The act of <i>synchronising</i> a <i>Generation Unit</i> to the <i>power system</i> .
<b>synchronised</b>	In the case of a <i>Generation Unit</i> , to be <i>connected</i> to and <i>operate</i> at the same <i>frequency</i> as the <i>power system</i> .
<b>synchronising, synchronisation</b>	To electrically <i>connect</i> a <i>Generation Unit</i> to the <i>power system</i> .
<b>synchronous condensers</b>	<i>Plant</i> , similar in construction to a <i>Generation Unit</i> of the <i>synchronous Generator</i> category, which operates at the equivalent speed of the <i>frequency</i> of the <i>power system</i> , specifically provided to generate or absorb <i>reactive power</i> through the adjustment of excitation current.
<b>unsynchronised</b>	<del>In the case of a <i>Generation Unit</i>, to operate disconnected from the power system, or to operate at a different frequency to the power system during an electrical disturbance.</del>
<b>under frequency load shedding</b>	<del>A <i>load shedding</i> scheme designed to automatically disconnect load on the network to restore frequency to the normal operating range.</del>
<b>under frequency relay</b>	<del>The component of an <i>under frequency load shedding</i> scheme that initiates disconnection of the load.</del>
<b>synchronous Generator voltage control</b>	The automatic <i>voltage control</i> system of a <i>Generation Unit</i> of the <i>synchronous Generator</i> category which changes the output <i>voltage</i> of the <i>Generation Unit</i> through the adjustment of the <i>Generator</i> excitation current and

effectively changes the reactive power output from that ~~Generation Unit~~generating unit.

**synchronous Generator, synchronous generating unit system strength connection works**

The alternating current ~~Generators~~ which operate at the equivalent of the frequency of the power system in its satisfactory operating state.

Investment in a transmission or distribution system in order to remedy or avoid an adverse system strength impact arising from establishing a connection for a generating system or from any alteration to a generating system.

**system strength impact assessment**

Power system studies to assess the impact of the connection of a new generating system or of any proposed alteration to a generating system on the ability under different operating conditions of:

- (a) the power system to maintain system stability; and
- (b) generating systems and market network service facilities forming part of the power system to maintain stable operation including following any credible contingency event or protected event,

so as to maintain the power system in a secure operating state.

**system strength impact assessment guidelines**

The guidelines for conducting system strength impact assessments developed by the Network Operator under clause 3.3.5.16.

**system strength remediation scheme**

A scheme required to be implemented as a condition of a connection agreement to remedy or avoid an adverse system strength impact.

Terminology	Definition
<b>synchronous Generation Unit</b>	of the frequency of the power system in its satisfactory operating state.
<b>tap-changing transformer</b>	A transformer with the capability to allow internal adjustment of output voltages which can be automatically or manually initiated and which is used as a major component in the control of the voltage of the networks in conjunction with the operation of reactive plant.
<b>technical envelope</b>	The limits described in clause 4.2.2.
<b>teleprotection signalling</b>	Equipment used to transfer a contact state from one location to another using communications equipment. The equipment used for this purpose will meet the reliability and quality requirements protection equipment.
<b>time</b>	Central Australian Standard Time, in the Northern Territory as defined by the National Measurement Standard Time Act, 1960-2005 (NT).
<b>total fault clearance time</b>	Refers to the time from fault inception to the time of complete fault interruption by a circuit breaker or circuit breakers.
<b>transformer</b>	A plant or device that reduces or increases the voltage of alternating current.
<b>transformer tap position</b>	Where a tap changer is fitted to a transformer, each tap position represents a change in voltage ratio of the transformer which can be manually or automatically adjusted to change the transformer output voltage. The tap position is used as a reference for the output voltage of the transformer.
<b>transmission element</b>	A single identifiable major component of a transmission network involving: <ul style="list-style-type: none"> <li>an individual transmission circuit or a phase of that circuit; and</li> <li>a major item of transmission plant necessary for the functioning of a particular transmission circuit or connection point (such as a transformer or a circuit breaker).</li> </ul>
<b>transmission line</b>	A power line that is part of a transmission network.
<b>transmission network</b>	The components of the electricity network used for transmitting electricity at nominal voltages of 66 kV or higher and at a nominal frequency of 50Hz.
<b>transmission network connection point</b>	A connection point on a transmission network.
<b>transmission network test</b>	Test conducted to verify the magnitude of the power transfer capability of the transmission network or investigating power system performance in accordance with clause 5.5.5.5.
<b>transmission plant</b>	Apparatus or equipment associated with the function or operation of a transmission line or an associated substation, which may include transformers, circuit breakers, reactive plant and monitoring equipment and control equipment.
<b>transmission system</b>	A transmission network, together with the connection assets associated with the transmission network, which is connected to another transmission or distribution system.

***trip circuit supervision***

A function incorporated within a *protection scheme* that results in alarming for loss of integrity of the *protection scheme's* trip circuit. *Trip circuit supervision supervises a protection scheme's trip supply together with the integrity of associated wiring, cabling and circuit breaker trip coil.*



Terminology	Definition
	<del>Trip circuit supervision supervises a protection scheme's trip supply together with the integrity of associated wiring, cabling and circuit breaker trip coil.</del>
<b>trip supply supervision</b>	A function incorporated within a <i>protection scheme</i> that results in alarming for loss of trip <i>supply</i> .
<b>two fully independent protection schemes of differing principle</b>	Where an item of <i>plant</i> is required to be protected by <i>two fully independent protection schemes of differing principle</i> , such <i>protection schemes</i> shall, in combination, provide dependable clearance of faults on that <i>plant</i> within a specified <i>time</i> , with any single failure to operate of the <i>secondary plant</i> . To achieve this, complete <i>secondary plant</i> redundancy is required including, but not necessarily limited to, <i>current transformer</i> and <i>voltage transformer</i> secondaries, auxiliary supplies, signalling systems, cabling, wiring, and circuit breaker trip coils. Auxiliary supplies include DC supplies for <i>protection</i> purposes. Therefore, to satisfy the redundancy requirements, each fully independent <i>protection scheme</i> would need to have its own independent battery and battery charger system <i>supplying</i> all that <i>protection scheme's</i> trip functions. The <i>protection schemes</i> shall be so chosen as to have <i>differing principles</i> of operation.
<b>under frequency load shedding</b>	<del>Equipment</del> A <i>load shedding scheme</i> designed to automatically disconnect <i>load</i> <del>from</del> on the <i>power system</i> if the <i>network</i> to restore frequency falls below a set level to the <i>normal operating range</i> .
<b>under voltage load shedding</b>	Equipment designed to automatically <i>disconnect load</i> from the <i>power system</i> if the <i>voltage</i> falls below a set level.
<b>under frequency relay</b>	The component of an <i>under frequency load shedding scheme</i> that initiates disconnection of the <i>load</i> .
<b>unsynchronised</b>	In the case of a <i>generating unit</i> , to operate <i>disconnected from the power system</i> , or to operate at a different frequency to the <i>power system</i> during an electrical disturbance.
<b>User</b>	A person, whether a <del>load</del> <i>Network User</i> or a <i>Generator User</i> , who has been granted access to the <i>electricity network</i> by the <i>Network Operator</i> in order to transport electrical <i>energy</i> to or from a particular point.
<b>use of system services</b>	A <i>network service</i> provided to a <i>User</i> for use of the <i>electricity network</i> for the transportation of electrical <i>energy</i> that can be reasonably allocated to a <i>User</i> on a locational basis.
<b>voltage</b>	The electronic force or electric potential between two points that gives rise to the flow of electrical <i>energy</i> .
<b>voltage control</b>	Keeping <i>network voltages</i> within operational limits in normal operation and in the aftermath of trips by automatic regulation of <del>Generation</del> <i>generation</i> MVar output or by <i>voltage control</i> equipment such as <i>capacitor banks</i> and automatic tap-changers.
<b>voltage transformer (VT)</b>	A <i>transformer</i> for use with meters and/or <i>protection</i> devices in which the <i>voltage</i> across the secondary terminals

is, within prescribed error limits, proportional to and in phase with the *voltage* across the primary terminals.

## Attachment 2\_ Rules of interpretation

Subject to the *Interpretation Act*, this *Code* shall be interpreted in accordance with the following rules of interpretation, unless the contrary intention appears:

- (a) a reference in this *Code* to a contract or another instrument includes a reference to any amendment, variation or replacement of it;
- (b) a reference to a person includes a reference to the person's executors, administrators, successors, substitutes (including, without limitation, persons taking by novation) and assigns;
- (c) if an event shall occur on a *day* which is not a *business day* then the event shall occur on the next *business day*;
- (d) any calculation shall be performed to the accuracy, in terms of a number of decimal places, determined by the *Network Operator* in respect of all *Users*;
- (e) if examples of a particular kind of conduct, thing or condition are introduced by the word "including", then the examples are not to be taken as limiting the interpretation of that kind of conduct, thing or condition;
- (f) a *connection* is a *User's connection* or a *connection* of a *User* if it is the subject of an [Access Agreement between the User and the Network Operator; and](#)  
~~[Access Agreement between the User and the Network Operator; and](#)~~
- (g) a reference to a half hour is a reference to a 30 minute period ending on the hour or on the half hour and, when identified by a *time*, means the 30 minute period ending at that *time*.

## Attachment 3 \_ Technical details for *connection* and access

### A3.1 Introduction

Various clauses of the *Code* require that *Users* submit technical data to the *Network Operator*. This attachment contains schedules which list the typical range of data which may be required. Data additional to those listed in the schedules may be required. The actual data required will be advised by the *Network Operator* at the *time* of assessment of a *network Access Application*, and will form part of the technical specification in the *Access Agreement*.

### A3.2 Data categories

Data is ~~Coded~~ coded in categories, according to the stage at which it is available in the build-up of data during the process of forming a *connection* or obtaining access to a *network*, with data acquired at each stage being carried forward, or enhanced in subsequent stages, for example by testing.

#### A3.2.1- \_\_\_\_\_ Preliminary system planning data

This is data required for submission with the *Access Application*, to allow the *Network Operator* to prepare an offer of terms for an *Access Agreement* and to assess the requirement for, and effect of, *network augmentation* or *extension* options. Such data is normally limited to the items denoted as Standard Planning Data (S) in the technical data schedules S3.1 to S3.7.

The *Network Operator* may, in cases where there is reasonable doubt as to the viability of a proposal, require the submission of other data before making an access offer to *connect* or to amend an *Access Agreement*.

#### A3.2.2- \_\_\_\_\_ Registered system planning data

This is the class of data which will be included in the *Access Agreement* signed by both parties. It consists of the preliminary system planning data plus those items denoted in the attached schedules as Detailed Planning Data (D). The latter shall be submitted by the *User* in *time* for inclusion in the *Access Agreement*.

##### Registered data

Registered Data consists of data validated and *augmented* prior to actual *connection* as a provision of access, from manufacturers' data, detailed design calculations, works or site tests, etc. (R1); and data derived from on-system testing after *connection* (R2).

All of the data will, from this stage, be categorised and referred to as Registered Data; but for convenience the schedules omit placing a higher ranked *Code* next to items which are expected to already be valid at an earlier stage.

### A3.3 Data review

Data will be subject to review at reasonable intervals to ensure its continued accuracy and relevance. The *Network Operator* shall initiate this review. A *User* may

change any data item at a time other than when that item would normally be reviewed or updated by submission to the *Network Operator* of the revised data, together with authentication documents, e.g. test reports.

#### A3.4 Data schedules

Schedules S3.1 to S3.7 cover the following data areas:

- (a) Schedule S3.1 - *Generation Generating Unit* Design Data. This comprises *Generation Unit generating unit fixed design parameters*.
- (b) Schedule S3.2 - *Generation Generating Unit* Setting Data. This comprises settings which can be varied by agreement or by *direction* of the *Network Operator*.
- (c) Schedule S3.3 – *Generator* data for small *Generation Units generating units*
- (d) Schedule S3.4 – Technical data for *Small Inverter Energy Units*
- (e) Schedule S3.5 - *Network and Plant* Technical Data. This comprises fixed electrical parameters.
- (f) Schedule S3.6 - *Plant and Apparatus* Setting Data. This comprises settings which can be varied by agreement or by *direction* of the *Network Operator*.
- (g) Schedule S3.7 - *Load* Characteristics. This comprises the estimated parameters of *load* groups in respect of, for example, harmonic content and response to *frequency* and *voltage* variations.

#### A3.5 Non synchronous Generators

A *Generator* that connects a *Generation Unit generating unit*, that is not a *synchronous Generation Unit generating unit*, shall be given exemption from complying with those parts of schedules S3.1 and S3.2 that are determined by the *Network Operator* to be not relevant to such *Generation Units generating unit*, but shall comply with those parts of Schedules S3.3, S3.5, and S3.6 that are relevant to such *Generation Units generating units*, as determined by the *Network Operator*.

Codes:

S = Standard Planning Data

D = Detailed Planning Data

R = Registered Data (R1 pre-connection, R2 post-connection)

|

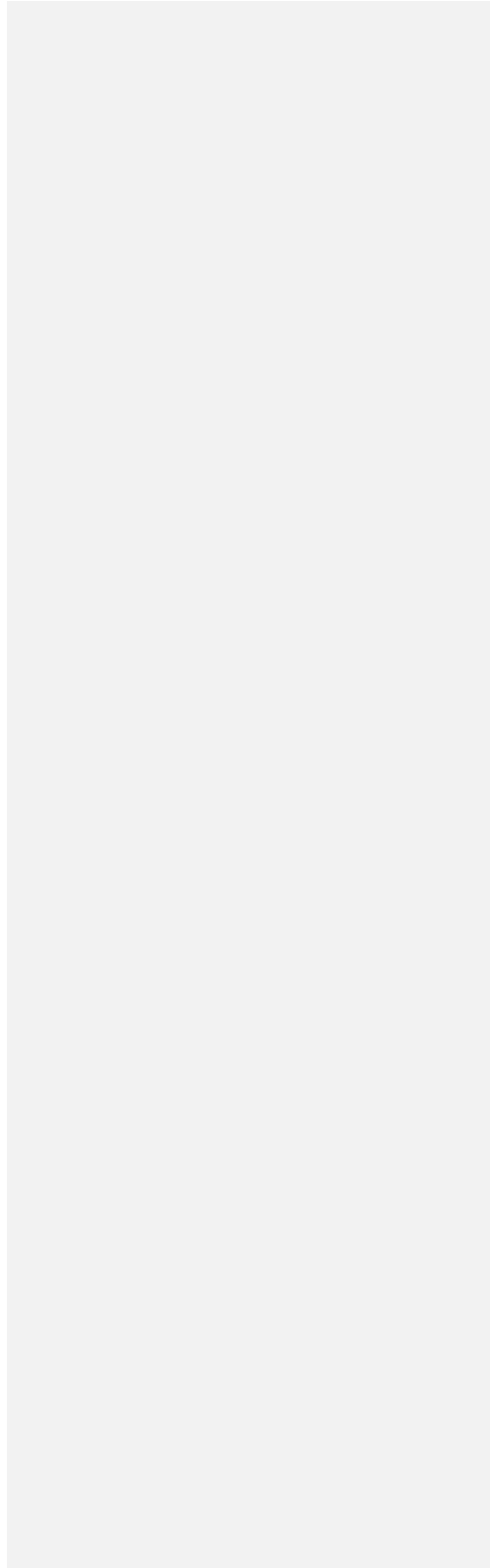

### Schedule S3.1 ~~Generation Unit~~ Generating unit design data

Symbol	Data Description	Units	Data Category
<b>Power station technical data:</b>			
	Connection point to Network	Text, diagram	S, D
	Nominal voltage at connection to Network	kV	S
	Total Station Net Maximum Capacity (NMC)	MW (sent out)	S, D, R2
<b>At connection point:</b>			
	Maximum 3 phase short circuit infeed calculated by method of AS 3851 (1991 ):		
	• Symmetrical	kA	S, D
	• Asymmetrical	kA	D
	Minimum zero sequence impedance	% on 100 MVA _base	D
	Minimum negative sequence impedance	% on 100 MVA _base	D
	<u>Short circuit ratio</u>	<u>Numeric ratio</u>	<u>S, D, R1</u>
	<u>The lowest short circuit ratio at the connection point for which the generating system, including its control systems: (i) will be commissioned to maintain stable operation; and (ii) has the design capability to maintain stable operation.</u>		
	<u>For the purposes of the above, "short circuit ratio" is the synchronous three phase fault level (expressed in MVA) at the connection point divided by the rated output of the generating system (expressed in MW or MVA).</u>		
<b>Individual <del>Generation Unit</del>generating unit data:</b>			
MBASE	Rated MVA	MVA	S, D, R1
PSO	Rated MW (Sent Out)	MW (sent out)	S, D, R1
PMAX	Rated MW (Generated)	MW (Gen)	S, D
VT	Nominal Terminal Voltage	kV	S, D, R1
PAUX	Auxiliary load at PMAX	MW	S, D, R2
Qmax	Rated Reactive Output at PMAX	MVA <sub>r</sub> (sent out)	S, D, R1
PMIN	Minimum Load (ML)	MW (sent out)	S, D, R2
H	Turbine plus Generator Inertia Constant	MWs/rated MVA	S, D, R1
Hg	Generator Inertia Constant (applicable to synchronous condenser mode of operation)	MWs/rated MVA	S, D, R1

GSCR	Short Circuit Ratio		D, R1
ISTATOR	Rated Stator Current	A	D, R1
IROTOR	Rated Rotor Current at rated MVA and <i>Power factor</i> , rated terminal volts and rated speed	A	D, R1
VROTOR	Rotor <i>Voltage</i> at which IROTOR is achieved	V	D, R1
VCEIL	Rotor <i>Voltage</i> capable of being supplied for five seconds at rated speed during field forcing	V	D, R1
<b><del>Generation Unit</del>Generating unit resistance:</b>			
RA	Stator Resistance	% on MBASE	S, D, R1, R2



RF	Rotor resistance at 20 ° C	ohms	S, D, R1
----	----------------------------	------	----------

**Generation Unit: Generating unit sequence impedances (saturated):**

Z0	Zero Sequence Impedance	(a+jb)% on MBASE	D,R1
Z2	Negative Sequence Impedance	(a+jb)% on MBASE	D,R1

**Generation Unit: Generating unit reactances (saturated):**

XD'(sat)	Direct Axis Transient Reactance	% on MBASE	D,R1
XD''(sat)	Direct Axis Sub-Transient Reactance	% on MBASE	D,R1

**Generation Unit: Generating unit reactances (unsaturated):**

XD	Direct Axis Synchronous Reactance	% on MBASE	S, D, R1, R2
XD'	Direct Axis Transient Reactance	% on MBASE	S, D, R1, R2
XD''	Direct Axis Sub-Transient Reactance	% on MBASE	S, D, R1, R2
XQ	Quadrature Axis Synch Reactance	% on MBASE	S, D, R1, R2
XQ'	Quadrature Axis Transient Reactance	% on MBASE	S, D, R1, R2
XQ''	Quadrature Axis Sub-Transient Reactance	% on MBASE	S, D, R1, R2
XL	Stator Leakage Reactance	% on MBASE	S, D, R1, R2
XO	Zero Sequence Reactance	% on MBASE	S, D, R1
X2	Negative Sequence Reactance	% on MBASE	S, D, R1
XP	Potier Reactance	% on MBASE	S, D, R1

**Generation Unit: Generating unit time constants (unsaturated):**

TDO'	Direct Axis Open Circuit Transient	Seconds	S, D, R1, R2
TDO''	Direct Axis Open Circuit Sub-Transient	Seconds	S, D, R1, R2
TKD	Direct Axis Damper Leakage	Seconds	S, D, R1, R2
TQO'	Quadrature Axis Open Circuit Transient	Seconds	S, D, R1, R2
TQO''	Quadrature Axis Open Circuit Sub-Transient	Seconds	S, D, R1, R2

**Charts:**

GCD	Capability Chart	Graphical data	S, D, R1, R2
GOCC	Open Circuit Characteristic	Graphical data	R1
GSCC	Short Circuit Characteristic	Graphical data	R1
GZPC	Zero power factor curve	Graphical data	R1
	V curves	Graphical data	R1

GOTC

MW, MVAR outputs versus temperature  
chart

Graphical data

D, R1, R2

~~Generation Unit~~Generating unit transformer:

GTW	Number of windings	Text	S, D
GTR <sub>n</sub>	Rated MVA of each winding	MVA	S, D, R1
GTTR <sub>n</sub>	Principal tap rated <i>voltages</i>	kV/kV	S, D, R1
GTZI <sub>n</sub>	Positive Sequence Impedances (each wdg)	(a - jb)% on 100 MVA base	S, D, R1
GTZ2 <sub>n</sub>	Negative Sequence Impedances (each wdg)	(a - jb)% on 100 MVA base	S, D, R1
GTZ0 <sub>n</sub>	Zero Sequence Impedances (each wdg)	(a - jb)% on 100 MVA base	S, D, R1
	Tapped Winding	Text, diagram	S, D, R1
GTAPR	Tap <i>Change</i> Range	kV -- kV	S, D
GTAPS	Tap <i>Change</i> Step Size	%	S, D
	Tap <i>Changer</i> Type, On/Off load	On/Off	S, D
	Tap <i>Change</i> Cycle Time	Seconds	D
GTVG	Vector Group	Diagram	S, D
	Earthing Arrangement	Text, diagram	S, D
	Saturation curve	Diagram	R1

**Generation Unit** *Generating unit* reactive capability (at machine terminals):

Lagging <i>Reactive power</i> at PMAX	MVA <sub>r</sub> export	S, D, R2
Lagging <i>Reactive power</i> at ML	MVA <sub>r</sub> export	S, D, R2
Lagging <i>Reactive Short Time</i> capability at rated MW, terminal <i>voltage</i> and speed	MVA <sub>r</sub> (for <i>time</i> )	D, R1, R2
Leading <i>Reactive power</i> at rated MW	MVA <sub>r</sub> import	S, D, R2

**Generation Unit** *Generating unit* excitation system:

Make		S, D
Model		S, D
General description of <i>excitation control system</i> (including functional block diagram)	Text, diagram	S, D
Rated <i>Field Voltage</i> at rated MVA and <i>Power factor</i> and rated terminal volts and speed	V	S, D, R1
Maximum <i>Field Voltage</i>	V	S, D, R1
Minimum <i>Field Voltage</i>	V	S, D, R1
Maximum rate of <i>change</i> of <i>Field Voltage</i>	Rising V/s	S, D, R1
Maximum rate of <i>change</i> of <i>Field Voltage</i>	Falling V/s	S, D, R1
<b>Generation Unit</b> <i>Generating unit</i> and exciter Saturation Characteristics 50 - 120%	Diagram	S, D, R1

Dynamic Characteristics of Over Excitation Limiter	Text/ Block diagram	S, D, R2
<u>Dynamic Characteristics of Under Excitation Limiter</u>	<u>Text/ Block diagram</u>	<u>S, D, R2</u>

**Generating unit load controller (governor):**

<u>General description of governor control system (including functional block diagram). Format to be compatible with PSS/E software from Siemens PTI.</u>	<u>Text, diagram</u>	<u>S, D</u>
<u>Maximum Droop</u>	<u>%</u>	<u>S, D, R1</u>
<u>Normal Droop</u>	<u>%</u>	<u>D, R1</u>
<u>Minimum Droop</u>	<u>%</u>	<u>D, R1</u>
<u>Maximum Frequency Dead band</u>	<u>Hz</u>	<u>D, R1</u>
<u>Normal Frequency Dead band</u>	<u>Hz</u>	<u>D, R1</u>
<u>Minimum Frequency Dead band</u>	<u>Hz</u>	<u>D, R1</u>
<u>MW Dead band</u>	<u>MW</u>	<u>D, R1</u>

**Generating unit response capability:**

<u>Sustained response to frequency change</u>	<u>MW/Hz</u>	<u>D, R2</u>
<u>Non-sustained response to frequency change</u>	<u>MW/Hz</u>	<u>D, R2</u>
<u>Load Rejection Capability</u>	<u>MW</u>	<u>S, D, R2</u>

**Mechanical shaft model:**

**(Multiple-stage steam turbine Generators only)**

<u>Dynamic model of turbine/Generator shaft system in lumped element form showing component inertias, damping and shaft stiffness. Format to be compatible with PSS/E software from Siemens PTI.</u>	<u>Diagram</u>	<u>S, D</u>
<u>Natural damping of shaft torsional oscillation modes (for each mode)</u>		
• <u>Modal frequency</u>	<u>Hz</u>	<u>D</u>
• <u>Logarithmic decrement</u>	<u>Nepers/Sec</u>	<u>D</u>

**Steam turbine data:**

**(Multiple-stage steam turbines only)**

<u>Fraction of power produced by each stage:</u>			
<u>Symbols</u>	<u>KHP</u>	<u>Per unit of Pmax</u>	<u>D</u>
	<u>KIP</u>		
	<u>KLP1</u>		
	<u>KLP2</u>		

Stage and reheat *time* constants:

<u>Symbols</u>		<u>Seconds</u>	<u>D</u>
<u>THP</u>			
<u>TRH</u>			
<u>TIP</u>			
<u>TLP1</u>			
<u>TLP2</u>			

Dynamic Characteristics of Under-Excitation Limiter	Text/ Block diagram	S, D, R2
<b>Generation Unit load controller (governor):</b>		
General description of governor control system (including functional block diagram). Format to be compatible with PSS/E software from Siemens-PTI.	Text, diagram	S, D
Maximum Droop	%	S, D, R1
Normal Droop	%	D, R1
Minimum Droop	%	D, R1
Maximum Frequency Dead band	Hz	D, R1
Normal Frequency Dead band	Hz	D, R1
Minimum Frequency Dead band	Hz	D, R1
MW Dead band	MW	D, R1
<b>Generation Unit response capability:</b>		
Sustained response to frequency change	MW/Hz	D, R2
Non-sustained response to frequency change	MW/Hz	D, R2
Load Rejection Capability	MW	S, D, R2
<b>Mechanical shaft model:</b>		
<b>(Multiple stage steam turbine Generators only)</b>		
Dynamic model of turbine/Generator shaft system in lumped element form showing component inertias, damping and shaft stiffness. Format to be compatible with PSS/E software from Siemens-PTI.	Diagram	S, D
Natural damping of shaft torsional oscillation modes (for each mode)		
— Modal frequency	Hz	D
— Logarithmic decrement	Nepers/Sec	D
<b>Steam turbine data:</b>		
<b>(Multiple stage steam turbines only)</b>		
Fraction of power produced by each stage:		
Symbols	KHP KIP KLP1 KLP2	Per unit of Pmax
Stage and reheat time constants:		

Symbols	IHP	Seconds	D
	IRH		
	IIP		
	IIP1		
	IIP2		

Turbine *frequency* tolerance curve      Diagram      S, D, R1

**Gas turbine data:**

HRSG	Waste heat recovery boiler <i>time</i> constant (where applicable <i>e.g.</i> for cogeneration equipment)	Seconds	D
	MW output versus turbine speed (47-52_Hz)	Diagram	D, R1, R2
	Type of turbine (heavy industrial, aero derivative etc.)	Text	S
	Number of shafts		S,D
	Gearbox Ratio		D
	Fuel type (gas, liquid)	Text	S,D
	Base <i>load</i> MW vs temperature	Diagram	D
	<i>Peak load</i> MW vs temperature	Diagram	D
	Rated exhaust temperature	°C	S,D
	Controlled exhaust temperature	°C	S,D,R1
	Turbine <i>frequency</i> tolerance capability	Diagram	D
	Turbine compressor surge map	Diagram	D

**Hydraulic turbine data**

Required data will be advised by the *Network Operator*

**Wind farm/wind turbine data**

A typical 24 hour power curve measured at 15-minute intervals or better if available;		S, D, R1
maximum_kVA output over a 60 second interval		S, D,R1
Long-term flicker factor for <i>Generation Unit#generating unit</i>		S, D, R1
Long term flicker factor for wind farm		S,D,R1
Maximum output over a 60 second interval_kVA		S,D,R1
Harmonics current spectra	A	S,D,R1
Power curve MW vs. _wind speed	Diagram	D
Spatial Arrangement of wind farm	Diagram	D

Startup profile MW, MVA<sub>r</sub> vs *time* for  
individual Wind Turbine Unit and Wind farm  
Total

Diagram

D



~~Total~~

	Low Wind Shutdown profile MW, MVA vs <i>time</i> for individual Wind Turbine Unit and Wind farm Total	Diagram	D
	MW, MVA vs <i>time</i> profiles for individual Wind Turbine Unit under normal ramp up and ramp down conditions.	Diagram	D
	High Wind Shutdown profile MW, MVA vs <i>time</i> for individual Wind Turbine Unit and Wind farm Total	Diagram	D

**Induction ~~Generation Unit~~generating unit data**

	Make		
	Model		
	Type (squirrel cage, wound rotor, doubly fed)		
MBASE	Rated MVA	MVA	S,D,R1
	PSO Rated MW (Sent out)	MW	S,D,R1
	PMAX Rated MW ( <i>generated</i> )	MW	D
	VT Nominal Terminal Voltage -kV	S,D,R1	
	Synchronous Speed	rpm	S,D,R1
	Rated Speed	rpm	S,D,R1
	Maximum Speed	rpm	S,D,R1
	Rated <i>Frequency</i>	Hz	S,D,R1
Qmax	Reactive consumption at PMAX	MVAr import	S,D,R1
	Curves showing torque, <i>power factor</i> , efficiency, stator current, MW output versus slip (+ and -).	Graphical data	D,R1,R2
	Number of <i>capacitor banks</i> and MVAr size at rated <i>voltage</i> for each <i>capacitor bank</i> (if used).	Text	S
	Control philosophy used for VAr / <i>voltage control</i> .	Text	S
H	Combined inertia constant for all rotating masses <i>connected</i> to the <del>Generation Unit</del> generating unit shaft (for example, <del>Generation Unit</del> generating unit, turbine, gearbox, etc.) calculated at the synchronous speed	MW-sec/MVA	S,D,R1

**Resistance**

Rs	Stator resistance	% on MBASE	D,R1
----	-------------------	------------	------

Rs

Stator resistance versus slip curve, or two extreme values for zero (nominal) and unity (negative) slip

Graphical data or % on MBASE

D,R1

<b>Reactances (saturated)</b>			
X'	Transient reactance	% on MBASE	D,R1
X''	Subtransient reactance	% on MBASE	D,R1
<b>Reactances (unsaturated)</b>			
X	Sum of magnetising and primary winding leakage reactance.	% on MBASE	D,R1
X'	Transient reactance	% on MBASE	D,R1
X''	Subtransient reactance	% on MBASE	D,R1
Xl	Primary winding leakage reactance	% on MBASE	D,R1
<b>Time constants (unsaturated)</b>			
T'	Transient	sec	S,D,R1,R2
T''	Subtransient	sec	S,D,R1,R2
Ta	Armature	sec	S,D,R1,R2
To'	Open circuit transient	sec	S,D,R1,R2
To''	Open circuit subtransient	sec	S,D,R1,R2

#### **Converter data**

Control: *transmission* system commutated or self commutated

Additional data may be required by the *Network Operator*

#### **Doubly fed induction *Generation* *Unit* generating unit data**

Required data will be advised by the *Network Operator*

|

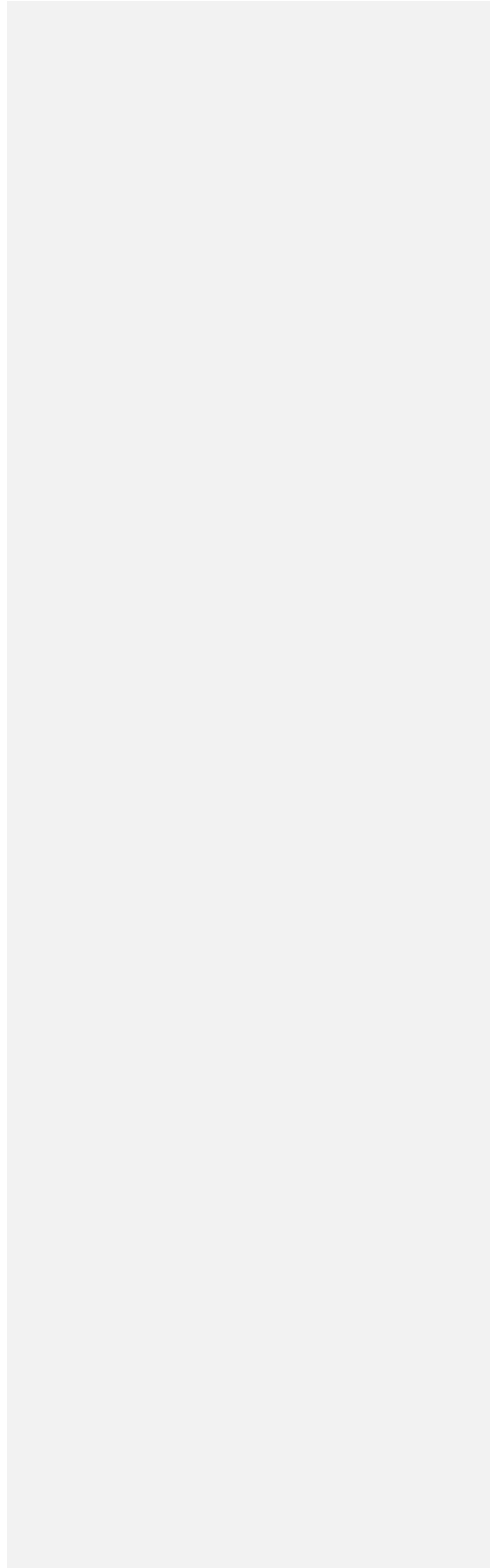

|

## Schedule S3.2 *Generation Unit* **Generating unit** setting data

Description Category	Units	Data Category
<b>Protection data:</b>		
<b>Settings of the following protections:</b>		
Loss of field	Text	D
Under excitation	Text, diagram	D
Over excitation	Text, diagram	D
Differential	Text	D
<i>Under frequency</i>	Text	D
<i>Over frequency</i>	Text	D
Negative sequence component	Text	D
Stator over <i>voltage</i>	Text	D
Stator overcurrent	Text	D
Rotor overcurrent	Text	D
Reverse power	Text	D
Stator E/F	Text	D
Rotor E/F	Text	D
Out of step	Text	D
<b>Control Data:</b>		
Details of <i>excitation control system</i> described in block diagram form showing transfer functions of individual elements, parameters and measurement units (in Siemens PTI PSS/E format).	Text, diagram	S, D, R1, R2
Automatic <i>voltage</i> regulator	Text, diagram	S, D, R1, R2
<i>Power system stabiliser</i>	Text, diagram	S, D, R1, R2
<b>Settings of the following controls:</b>		
Details of the <i>governor system</i> described in block diagram form showing transfer functions of individual elements and measurement units (in Siemens PTI PSS/E format).	Text, diagram	S, D, R1, R2
Over excitation limiter	Text, diagram	S, D
Under excitation limiter	Text, diagram	S, D
Stator current limiter (if fitted)	Text, diagram	S, D
Manual restrictive limiter (if fitted)	Text	S, D
<i>Load drop compensation</i> /VAR sharing (if fitted)	Text, function	S, D
V/f limiter (if fitted)	Text, diagram	S, D

|

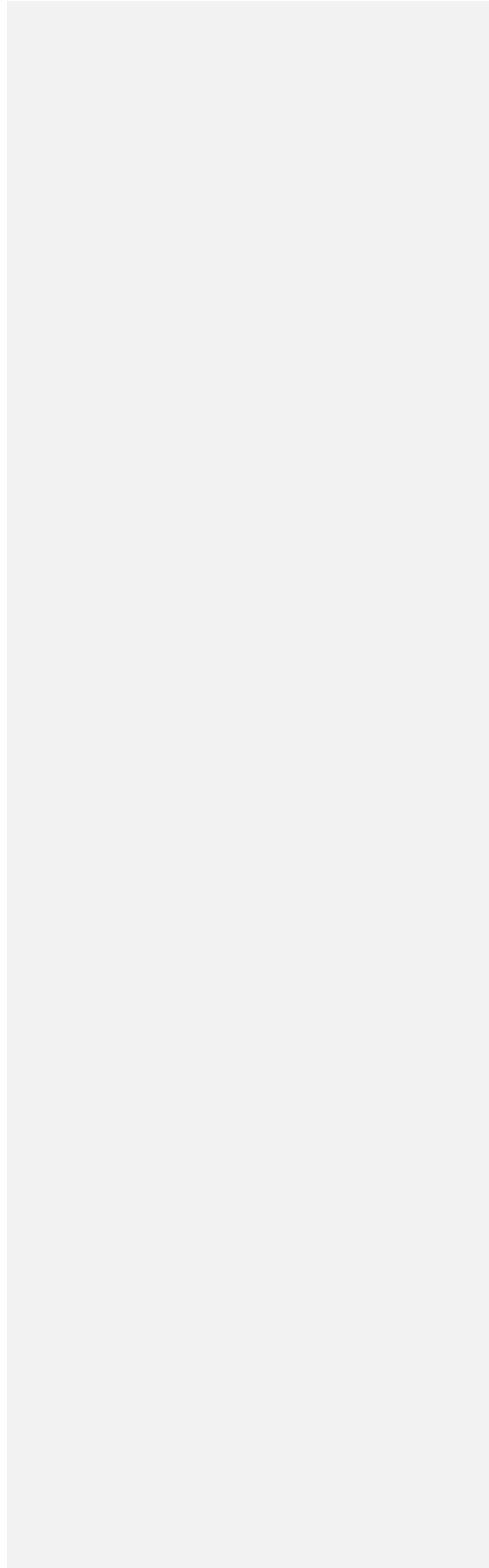

### Schedule S3.3 Generator data for small ~~Generation Units~~generating systems

Power station	Data Category
Address	S, R1
Description of <i>power station</i> , for example, is it a green or brownfield site, is there a process steam or heat requirement, any other relevant information	S
Site-specific issues which may affect access to site or design, <del>eg</del> . other construction onsite, mine site, environmental issues, soil conditions	S, D
Number of <del>Generation Units</del> <i>generating unit</i> and ratings (kW)	S, D, R1
Type: <del>eg</del> . synchronous, induction	S, D, R1
Manufacturer	D
Connected to the <i>network</i> via: <del>eg</del> . inverter, <i>transformer</i> , u/g cable etc.	S
Prime mover types: <del>eg</del> . reciprocating, turbine, hydraulic, photovoltaic, other	S
Manufacturer	D
<i>Energy source</i> : <del>eg</del> . natural gas, landfill gas, distillate, wind, solar, other	S
Total <i>power station</i> total capacity (kW)	S, D, R1
<i>Power station</i> export capacity (kVA)	S, D, R1
Forecast annual <del>energy</del> <i>generation</i> (kWh)	S, D
Normal mode of operation as per clause <del>3.4.3</del> <i>3.4.3</i> of the <i>Network Technical Code</i> <del>ie (1) i.e.</del>	S
(1) continuous parallel operation	
<del>(2)</del> <i>(2)</i> occasional parallel operation <del>(3)</del>	
<del>(2)</del> <i>(3)</i> short term test parallel operation	
<del>(3)</del> <i>(4)</i> bumpless (make before break) transfer	
(i) rapid transfer	
(ii) gradual transfer	
Purpose: <del>eg</del> . power sales, peak lopping, <i>demand management</i> , exercising, emergency back up	S

### Schedule S3.4 \_ Technical data for *Small Inverter Energy Systems*

Description	Units	Data Category
Address	Text	S
Number of <i>Small Inverter Energy Systems</i> and ratings	kW	S, D
Manufacturer	Text	D
<b>Connection voltage</b>		
Nominal <i>voltage</i>	V	S, D
Single/three phase	Number	S, D





## Schedule S3.5 *\_Network and plant technical data*

Description	Units	Data Category
<b>Voltage rating</b>		
Nominal <i>voltage</i>	kV	S, D
Highest <i>voltage</i>	kV	D
<b>Insulation co-ordination</b>		
Rated lightning impulse withstand <i>voltage</i>	kVp	D
Rated short duration power <i>frequency</i> withstand <i>voltage</i>	kV	D
<b>Rated currents</b>		
Circuit maximum current	kA	S, D
Rated Short <i>Time</i> Withstand Current	kA for seconds	D
Ambient conditions under which above current applies	Text	S,D
<b>Earthing</b>		
System Earthing Method	Text	S, D
Earth grid rated current	kA for seconds	D
<b>Insulation pollution performance</b>		
Minimum total creepage	mm	D
Pollution level	Level of IEC 815	D
<b>Controls</b>		
Remote control and data <i>transmission</i> arrangements	Text	D
<b>Metering provided by customer</b>		
Measurement <i>transformer</i> ratios:		D
Current <i>transformers</i>	A/A	D
Voltage <i>transformers</i>	V/kV	D
Measurement <i>Transformer</i> Test Certification details	Text	R1
<b>Network configuration</b>		
Operation Diagrams showing the electrical circuits of the existing and proposed main <i>facilities</i> within the <i>User's</i> ownership including <i>busbar</i> arrangements, phasing arrangements, earthing arrangements, switching <i>facilities</i>	Single line Diagrams	S, D, R1

and  
operating voltages

### Network impedances

For each item of *plant* (including lines): details of the positive, negative and zero sequence series and shunt impedances, including mutual coupling between physically adjacent elements.

	% on 100 MVA _base	S, D, R1
--	-----------------------	----------

### Short circuit infeed to the network

Maximum *Generator* 3-phase short circuit infeed including infeeds from *Generation Units/generating units* connected to the *User's* system, calculated by method of AS 3851 (1991).

	kA symmetrical	S, D, R1
--	----------------	----------

The total infeed at the instant of fault (including contribution of induction motors).

	kA	D, R1
--	----	-------

Minimum zero sequence impedance of *User's network* at *connection point*.

	% on 100 MVA _base	D, R1
--	-----------------------	-------

Minimum negative sequence impedance of *User's network* at *connection point*.

	% on 100 MVA _base	D, R1
--	-----------------------	-------

### Load Transfer Capability:

Where a *load*, or group of *loads*, may be fed from alternative

*connection points*:

*Load* normally taken from *connection point X*

	MW	D, R1
--	----	-------

*Load* normally taken from *connection point Y*

	MW	D, R1
--	----	-------

Arrangements for transfer under planned or fault *outage* *conditions*

	Text	D
--	------	---

### Circuits Connecting Embedded *Generation Units/generating units* to the Network:

For all *Generation Units/generating units*, all connecting lines/cables, *transformers* etc.

Series Resistance (-ve, -ve & zero seq.)

	% on 100 MVA _base	S, D, R
--	-----------------------	---------

Series Reactance (-ve, -ve & zero seq.)

	% on 100 MVA _base	S, D, R
--	-----------------------	---------

Shunt Susceptance (-ve, -ve & zero seq.)

	% on 100 MVA _base	S, D, R
--	-----------------------	---------

Normal and short-time emergency ratings

	MVA	S, D, R
--	-----	---------

Technical Details of *Generation Units/generating units* as per schedules S1, S2, S3.

**Transformers at connection points:**

Saturation curve

Diagram

R

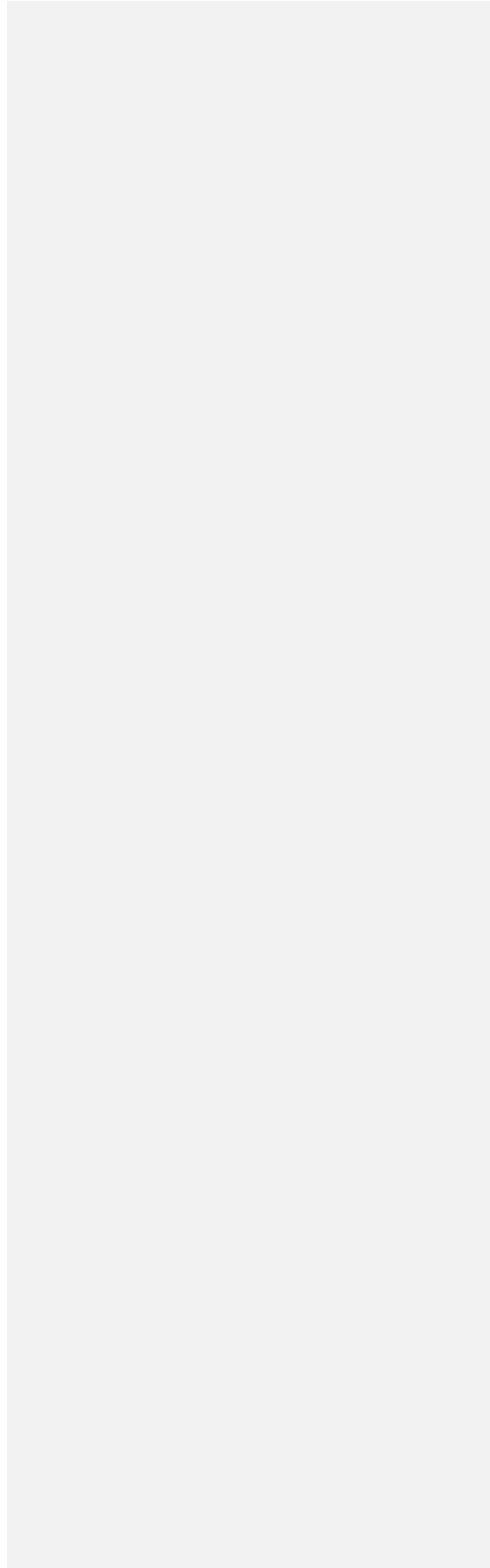

|

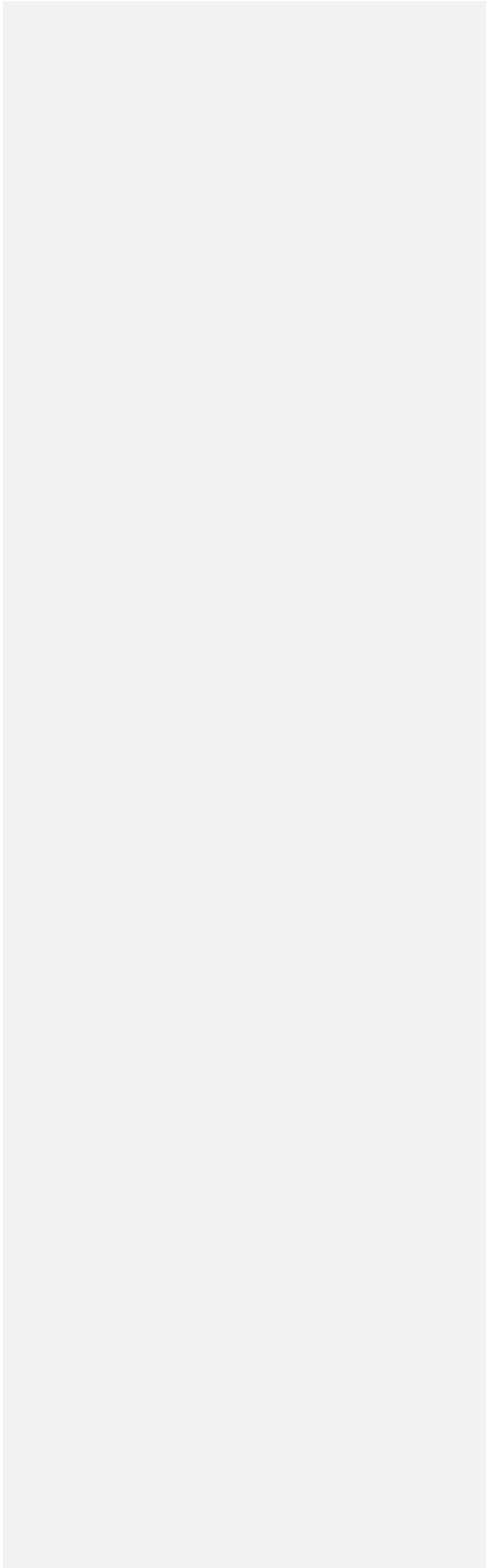

|

## Schedule S3.6 *\_Network plant and apparatus setting data*

Description	Units	Data Category
<b>Protection data for protection relevant to connection point:</b>		
Reach of all <i>protection schemes</i> on lines, or cables	ohms or % on 100 MVA base	S, D
Number of <i>protection schemes</i> on each item	Text	S, D
Total fault clearing <i>times</i> for near and remote faults	ms	S, D, R1
Line reclosure sequence details	Text	S, D, R1
<b>Tap change control data:</b>		
<i>Time</i> delay settings of all <i>transformer tap changers</i> .	Seconds	D, R1
<b>Reactive compensation (including filter banks):</b>		
Location and Rating of individual shunt <i>reactors</i>	MVAr	S, D, R1
Location and Rating of individual shunt <i>capacitor banks</i>	MVAr	S, D, R1
<i>Capacitor bank</i> capacitance	Microfarads	S, D
Inductance of switching <i>reactor</i> (if fitted)	millihenries	S, D
Resistance of capacitor plus <i>reactor</i>	Ohms	S, D
Details of special controls ( <i>e.g.g.</i> Point-on-wave switching)	Text	S, D
<b>For each shunt reactor or capacitor bank (including filter banks):</b>		
Method of switching	Text	S
Details of automatic control logic such that operating characteristics can be determined	Text	D, R1
<b>FACTS Installation:</b>		
Data sufficient to enable static and <i>dynamic performance</i> of the installation to be modelled	Text, diagrams, control settings	S, D, R1
<b>Under frequency load shedding scheme:</b>		
Relay settings ( <i>frequency and time</i> )	Hz, seconds	S, D
<b>Islanding scheme:</b>		
Triggering signal ( <i>e.g.g.</i> <i>voltage, frequency</i> )	Text	S, D
Relay settings	Control settings	S, D

|

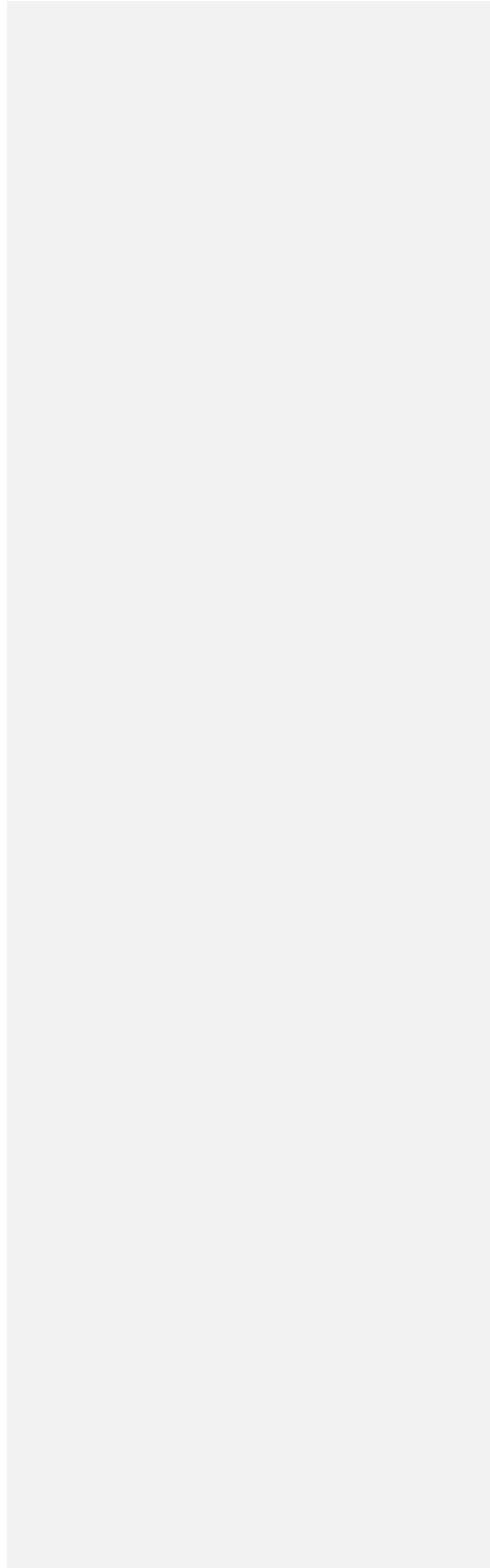

|



### Schedule S3.7 Load characteristics at connection point

Data Description	Units	Data Category
<b>For all types of load</b>		
Type of <del>Load</del> <u>load e.g.</u> controlled rectifiers or large motor drives	Text	S
Rated capacity	MW, MVA	S
Voltage level	kV	S
Rated current	A	S
<b>For fluctuating loads</b>		
Cyclic variation of <i>active power</i> over period	Graph - MW/time	S
Cyclic variation of <i>reactive power</i> over period	Graph - MVAr/time	S
Maximum rate of <i>change of active power</i>	MW/s	S
Maximum rate of <i>change of reactive power</i>	MVAr/s	S
Shortest Repetitive <i>time</i> interval between fluctuations in <i>active power</i> and <i>reactive power</i> reviewed annually	s	S
Largest step <i>change</i> in <i>active power</i>	MW	S
Largest step <i>change</i> in <i>reactive power</i>	MVAr	S
<b>For commutating power electronic load:</b>		
No. of pulses	Text	S
Maximum <i>voltage</i> notch	%	S
Harmonic current distortion (up to the 50th harmonic)	A or %	S

## Attachment 4 Metering requirements

### 18.5.1.1.1 A4.1 General

- (a) ~~Revenue metering equipment, other than revenue meters and Communications equipment may be provided and installed by the User or will be provided and installed by the Network Operator at the User's request.~~
- (b) ~~Indoor revenue metering units provided by the Network Operator will normally be of a type suitable for use with a specific make of switchgear which will vary from time to time.~~
- (c) ~~Revenue meters and the communications equipment other than a connection to the Public Switched Telephone Network (PSTN) will be provided and installed by the Network Operator. The PSTN connection and any isolation required will be provided by the User.~~
- (d) ~~Revenue metering equipment will comprise a revenue metering unit containing voltage transformers (VTs) and current transformers (CTs), or for system voltages of 66 kV and 132 kV, free standing post type VTs and CTs (other than free standing post type VTs and CTs may be acceptable and each request will be considered), two or more revenue meters, cabling, communications equipment, marshalling box and a revenue meter enclosure.~~

### 18.5.1.1.2 A4.2 Installation

- (a) ~~The maximum cable route length between the CTs and VTs and the revenue meters is 80 metres.~~
- (b) ~~Marshalling boxes located close to the CTs and VTs will be required for all indoor revenue metering units and for all outdoor revenue metering units for system voltages of 66 kV and 132 kV. Indoor revenue metering marshalling boxes will be an integral part of the indoor revenue metering unit.~~
- (c) ~~Prefabricated free standing or wall mounted revenue meter enclosures are available from the Network Operator or a suitable enclosure may be assembled by the User. Revenue meters may also be located within a building which has provision for unrestricted 24 hour access for revenue metering personnel. It may be located adjacent to the Network Operator's protection or SCADA equipment. Preference is for a purpose constructed, ventilated, insulated or naturally insulated room of plan dimensions not less than 2m X 2m which substantially maintains ambient air temperature. If the Network Operator is requested to provide a free standing revenue meter enclosure and its support frame, the User will need to provide a concrete footing as specified in the Network Operator's metering manuals.~~
- (d) ~~Unrestricted, 24 hour access to revenue metering equipment by revenue metering personnel is required.~~

### **A4.3 — 3-4 wire metering**

- (a) — Three-wire *revenue metering*, that is, *revenue metering* with three-phase to neutral VTs and two CTs, one in each of the red and blue currents, may be used when the load measured by the *revenue metering equipment* is a three-wire load. The load is three-wire when it comprises a delta-wound transformer primary or a star-wound transformer primary with the star point not earthed, provided the load is not a distributed load and is within 2 km of the *revenue metering CTs* and VTs and the system voltage is less than 66 kV. All other *revenue metering* will be four-wire, that is, as for three-wire but with an additional CT in the white phase. *Co-Generation revenue metering* will normally be four-wire.
- (b) — The *Network Operator* will, if requested by a *User*, advise the *User* whether an installation is 3-wire or 4-wire.

#### **18.5.1.1.3 A4.4 — Signals**

- (a) — Signals comprising *energy usage information* may be made available via volt-free relay contacts rated to 30V AC or DC at a maximum of 60 mA. These signals comprise momentary relay closures each time a given amount of *energy* (kWh) is imported or exported and each time a given number of kVAh is imported, the start of each 30-minute *demand* period (or other period if appropriate) and relay closures when the rate changes (on-peak or off-peak or shoulder etc.).

#### **18.5.1.1.4 A4.5 — Accuracy requirements**

**Table A4.1 — Overall Accuracy Requirements of Revenue metering installation**

**Schedule S4 Grace periods for purposes of clause 12.3**

Clause	Clause Title	Transition to Compliance Grace Period
3.3.5.1	Reactive power capability	13 months
3.3.5.2	Minimum acceptable class of components Quality of electricity generated	Meter clock error seconds 30 days
3.3.5.3	Generation unit response to frequency disturbance	30 days
3.3.5.4	Generating System Response to Voltage Disturbances	13 months
3.3.5.5	0.2 CT/VT/meter Wh 0.5 Meter VAh Generating System Response to Disturbances Following Contingency Events	±56 months
3.3.5.6	Quality of Electricity Generated and Continuous Uninterrupted Operation	30 days
3.3.5.7	±7 Partial Load Rejection	30 days
3.3.5.8	Protection of generating units from Power System Disturbances	30 days
3.3.5.9	Protection Systems that Impact on Power System Security	30 days
3.3.5.10	0.5 CT/VT Meter Wh 2.0 Meter VAh Protection to Trip Plant for Unstable Operation	30 days ±10
3.3.5.11	Frequency Control	30 days
3.3.5.12	Impact on Network Capability	30 days
3.3.5.13	Voltage and Reactive Power Control	30 days
3.3.5.14	Active Power Control	30 days
3.3.5.15	Inertia and Contingency FCAS	30 days
3.3.5.16	System Strength	30 days
3.3.5.17	Capacity Forecasting	13 months
3.3.6.1	Remote Monitoring and Control	30 days
3.3.6.2	Communications Equipment	30 days

**Note** Explanatory notes:

The transition to Table A4.1:

The method compliance timeframes includes the 30 days for calculating the overall error is the vector sum of the errors of each component part, ie generator to provide a – b – c, where:

- a = the error of the Voltage Transformer compliance plan and wiring b = the error of the Current Transformer and wiring confirm the generator performance standard GPS.

~~$\epsilon$  — the error of the revenue meter.~~

~~2. **A4.6 — Other metering**—The transition to compliance grace periods include all aspects including design, modelling, procurement, programming, installation and testing as appropriate~~

~~Clauses with 30 day timeframe to compliance reflect that the requirements~~

~~(a) Specifications for revenue meter and communications enclosures, indoor and outdoor revenue metering units (VTs and CTs plus enclosure), 66 kV and~~

~~2.3. 132 kV CTs, VTs, marshalling box and wiring are contained in the Network Operator's metering manuals either:~~

~~a. The same or equivalent outcome as those under the existing NTC V3.1; or~~

~~b. Not expected to result in a compliance gap.~~

~~4. For the clause with a 6 month timeframe, a compliance gap is considered at least possible, with any gap most likely related to a programming / setting change and testing to demonstrate compliance.~~

~~5. For the clauses with a 13 month timeframe, a potential compliance gap is considered possible, with that gap most likely related to requiring additional plant or equipment and testing to demonstrate compliance.~~

~~6. A generator may seek an extended derogation under NTC clause 12.1, but only where it can be justified, and the generator demonstrates its best endeavours to achieve timely compliance.~~

Attachment 4 [Deleted]

(a)

## Attachment 5 \_ Test schedule

The following test schedule is used for specific performance verification and model validation.

### A5.1 General

- (a) Recorders should be calibrated or checked prior to use.
- (b) Recorders should not interact with any *plant* control functions.
- (c) Galvanic isolation and filtering of input signals should be provided whenever necessary.

### A5.2 Test preparation and presentation of test results ~~information/data prior to tests~~

#### Information/data prior to tests

- (a) a detailed schedule of tests agreed by the *Network Operator*. The schedule should list the tests, when each test is to occur and whose responsibility it will be to perform the test.
- (b) Schematics of equipment and *sub-networks* plus descriptive material necessary to draw up/agree upon a schedule of tests
- (c) Most up to date relevant technical data and parameter settings of equipment as specified in Attachment 3 of this *Code*.

#### Test notification

- ~~(a)~~—Prior notice of test commencement should be given to the *Network Operator*
- (a) ~~for~~ for the purpose of arranging witnessing of tests.
  - (b) The *Network Operator's representative* should be consulted about proposed test schedules, be kept informed about the current state of the testing program, and give permission to proceed before each test is carried out.

#### Test results

- (a) Test result data shall be presented to the *Network Operator* within 5 *business days* of completion of each test or test series.
- (b) Where test results are not favourable it will be necessary to rectify problems and repeat tests.

### A5.3 Quantities to be measured

- (a) Wherever appropriate and applicable for the tests, the following quantities should be measured on the machine under test:

#### **Generator and excitation system**

- stator L-N terminal *voltages*
- stator terminal currents

- *Active power MW*
- *Reactive power MVAR*
- *Generator rotor field voltage*
- *Generator rotor field current*
- *Main exciter field voltage*
- *Main exciter field current*
- *AVR reference voltage*
- *Voltage applied to AVR summing junction (step etc.)*
- *Power system stabiliser output*
- *DC signal input to AVR which corresponds to terminal volts*

#### **Steam turbine**

- *Shaft speed*
- *Load demand signal*
- *Valve positions for control and interceptor valves*
- *Governor set point*

#### **Gas turbine**

- *Shaft speed (engine)*
- *Shaft speed of turbine driving the Generator*
- *Engine speed control output Free turbine speed control output*
- *Generator-compressor speed control output*
- *Ambient/turbine air inlet temperature*
- *Exhaust gas temperature control output*
- *Exhaust temperature*
- *Fuel flow*
- *Governor/load reference set point*

#### **Reciprocating engine**

- *Engine crank speed driving the Generator*
- *Type of governor load / speed control*
- *Ambient / charge air / exhaust temperature*



- Fuel flow
- (b) Additional test quantities may be requested and advised by the *Network Operator* if other special tests are necessary.
- (c) Key quantities such as stator terminal *voltages*, currents, *active power* and *reactive power* of the other ~~Generation Units~~*generating units* connected on the same bus and also *interconnection* lines with the *Network Operator's network* (from control room readings) before and after each test shall also be provided.

### Schedule of Tests

Test No	TEST DESCRIPTION		
	General Description	Changes Applied	Test Conditions
C1	Step change to AVR voltage reference with the <i>Generator</i> on <b>open circuit</b>	(a) <del>(a)</del> -2.5% (b) <del>(b)</del> -2.5% (c) <del>(c)</del> -5.0% (d) <del>(d)</del> -5.0%	nominal stator terminal volts
C2	Step change to AVR voltage reference with the <i>Generator</i> connected to the system at the following outputs 50% rated MW 100% rated MW	(a) <del>(a)</del> -1.0% (b) <del>(b)</del> -1.0% (c) <del>(c)</del> -2.5% (d) <del>(d)</del> -2.5% (e) <del>(e)</del> -5.0% (f) <del>(f)</del> -5.0% repeat (e) & (f) twice see notes below	nominal stator terminal volts unity or lagging <i>power factor</i> system base <i>load</i> <i>Generator</i> outputs: <u>(i)</u> 50% rated MW <u>(ii)</u> 100% rated MW all tests in (i) should precede test in (ii) smaller step changes should precede larger step changes
C3	As for C2 but with the <i>power system stabiliser</i> in service and with the system conditions (i) and (ii) as indicated in column 3 (Test Conditions)	As in C2	As in C2, but system base <i>load</i> with no other <del>Generation</del> generation on the same bus system maximum <i>load</i> and maximum <del>Generation</del> generation on same bus
C4	Manual variation of <i>Generator</i> open circuit <i>voltage</i>	Stator terminal <i>voltage</i> ( $U_t$ ) <del>(a)</del> increase from (a) 0.5 pu to 1.1 pu <del>(b)</del> decrease from (b) 1.1 pu to 0.5 pu	in 0.1 pu step for $U_t$ between 0.5 – 0.9 pu on 0.5 pu step for $U_t$ between 0.9 – 1.1 pu
C5	<i>Load</i> rejection ( <i>active power</i> )	(a) 25% rated MW (b) 50% rated MW (c) 100% rated MW	nominal stator terminal volts unity <i>power factor</i> smaller amount should precede larger amount of <i>load</i> rejection
C6	<i>Load</i> rejection ( <i>reactive power</i> )	(5) -30% rated MVar	nominal stator terminal volts 0 or minimum MW output

		(6) -25% rated MVA <sub>r</sub>	
C7	Load rejection (reactive power)	(a) <del>(a)</del> -30% rated MVA <sub>r</sub>	nominal stator terminal volts Excitation Manual Control

|

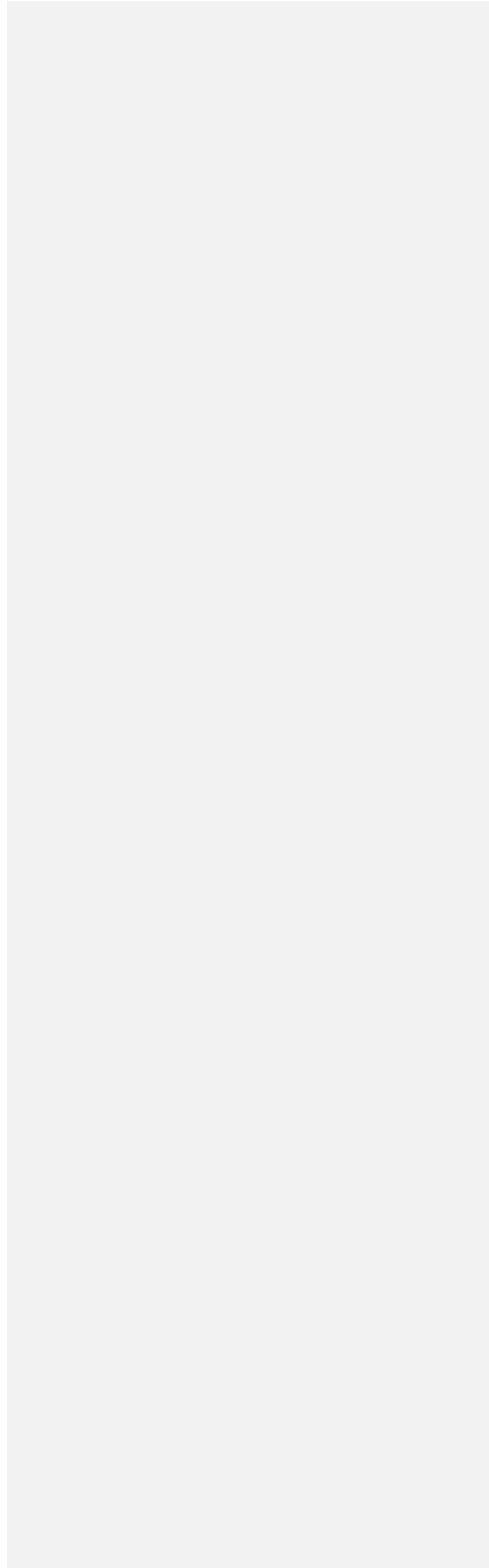

## Attachment 6 Access Application schedule

The following Schedule of information to be submitted in an *Access Application* is pursuant to Schedule 2 of the Electricity Networks (Third Party Access) Code.

### A6.1 Access Application information requirements

- (a) A person who is not an existing *User* and who wants the *Network Operator* to provide it with one or more *access services* shall make an *Access Application* in accordance with this schedule.
- (b) A person who is an existing *User* and who wants the *Network Operator* to provide it with one or more *access services* (including additional capacity) in addition to those which the *User* has access already shall make an *Access Application* in accordance with this schedule.
- (c) An *Access Application* may only be made for the provision of *access services* that the applicant wishes the *Network Operator* to commence to provide within 3 years of the date of the *Access Application*.
- (d) An *Access Application* shall contain the following information:
  - (1) the name and address of the person making the *Access Application* and of any other persons for whom that person is acting in making the *Access Application*;
  - (2) the type of network *access services* requested, when those *access services* are required and for how long they will be required;
  - (3) the entry points and exit points in respect of which access is being applied for and the capacity (expressed in kVA) for each of those entry points and exit points for which access is being applied for;
  - (4) the type of *plant* in respect of which the *access services* are required and the configuration of that *plant*;
  - (5) where the entry points and exit points are to be on the electrical *network* and any alternative points (in order of preference);
  - (6) the expected maximum demand of the *plant connected* or to be *connected* at each of the entry points;
  - (7) the maximum *Generation* capacity and the proposed declared sent out capacity of the *Generation Units* (including embedded *Generation Units*) *connected* or to be *connected* at each of the exit points;
  - (8) the expected electricity production and consumption of the *plant connected* or to be *connected* at each of the entry points and exit points;
  - (9) when the applicant expects the *plant* to be *connected* at each of the entry points and exit points to be in service (if appropriate);
  - (10) details of the *controllers* of the *plant connected* or to be *connected* at each of the entry points and exit points;

- ~~(11) the proposed design of each of the connections (if appropriate);~~
- ~~(12) the arrangements which the applicant proposes to enter into in relation to the construction and supply of the connection in respect of the plant;~~
- ~~(13) the nature of any disturbing load (size of disturbing component MW/MVAR, duty cycle, nature of power electronic plant which may produce harmonic distortion);~~
- ~~(14) any information as required by this Network Technical Code;~~
- ~~(15) commercial information concerning the applicant to allow the Network Operator to make an assessment of the ability of the applicant to meet its obligations under any Access Agreement that results from the Access Application; and~~
- ~~(16) any other information reasonably required by the Network Operator; and may specify that the applicant wishes the Network Operator to make a preliminary assessment of the application.~~

The following clauses are intended to provide a guide for existing and intending network Users (Access Applicants) on the process of connection to the network. Full details of the network connection procedures and the obligations of participants and the Network Operator are contained in Chapter 2 and Schedules 2, to 5 of the Electricity Networks (Third Party Access) Code.

#### **A6.2 Access Application**

- ~~(a) The Access Applicant must lodge a written Access Application to the Network Operator containing the relevant information set out in Schedule 2 of the Electricity Networks (Third Party Access) Code.~~
- ~~(b) If necessary, the Network Operator may request further information from the Access Applicant within 7 days of its lodgement.~~
- ~~(c) Within 7 days of receiving an Access Application or further information, the Network Operator must notify:
  - ~~(1) the Utilities Commission; and~~
  - ~~(2) any network User that would be materially affected by the Access Application.~~~~

#### **A6.3 Initial response to Access Application by the Network Operator**

- ~~(a) The Network Operator shall provide the Access Applicant with a written initial response to an Access Application:
  - ~~(1) within 10 days of receiving an Access Application from an existing network user; or~~
  - ~~(2) within 21 days of receiving an Access Application from a new network user; or~~
  - ~~(3) where the Network Operator has requested further information, within an equivalent period after receiving that information.~~~~

- (b) The initial response by the *Network Operator* in respect of an *Access Application* shall include the following information:
- (1) the period within which the *Network Operator* is able to make a preliminary assessment of the *Access Application*; and
  - (2) an estimate of the reasonable expenses expected to be incurred by the *Network Operator* in processing the *Access Application*, preparing an initial response, carrying out a preliminary assessment, making an offer and negotiating the *Access Agreement*.

**A6.4 Preliminary assessment of *Access Application* by the *Network Operator***

- (a) If a preliminary assessment is requested in the *Access Application*, the *Network Operator* must make the assessment and give the *Access Applicant* a report of the assessment within the time period specified in the initial response to the *Access Application*.
- (b) A preliminary assessment shall include the following information:
- (1) whether it is likely that there is sufficient spare capacity to provide the *access services* requested in the *Access Application* or whether the *electricity network* will have to be augmented to provide those services;
  - (2) whether it is likely that any *connection* will have to be installed or upgraded to provide the *connection services* (if any) requested in the *Access Application*;
  - (3) whether or not a capital contribution will be required of the *Access Applicant* and if so, an indication of the likely amount of that capital contribution;
- (c) The information provided under clauses A6.3(b)(1), (b)(2) and (b)(3) above may be subject to change under conditions specified by the *Network Operator* in the preliminary assessment.

**18.5.1.1.5 A6.5 Access offer**

- (a) The *Network Operator* must make an access offer to provide to the *Access Applicant* the *network access services* requested in the *Access Application* within:
- (1) 30 days of receiving the request; or
  - (2) if within that period the *Network Operator* has requested further information, within 30 days after receiving the information;
- unless agreed by the *Access Applicant* and the *Network Operator*, or as otherwise approved by the *Utilities Commission*.





~~(b) The access offer by the Network Operator may require the Access Applicant to make a contribution towards capital investment to provide the requested access.~~

~~(c) If the Access Applicant does not conclude negotiations with the Network Operator within 60 days, the access offer expires and the Access Application lapses.~~

#### **A6.6—Access Agreement**

~~(a) The Network Operator will prepare an Access Agreement setting out the specific technical, commercial and legal conditions under which access to the network is provided, in accordance with Schedule 4 of the Electricity Networks (Third Party Access) Code.~~

~~The Access Applicant must execute the Access Agreement before a new or modified connection will be made to the network and is required to abide by the terms and conditions of the Access Agreement and this Code.~~