

Market Operator

NMI Allocation Procedure

Content

1. Purpose	1
2. Scope	1
3. Roles and Responsibilities	2
4. Definitions	2
5. Principles	3
6. References.....	6
7. Appendices	6
8. Records	6
9. Review	6
10. Document History.....	6
Appendix A: NMI Source.....	7
Appendix B: NMI Structure	8
Appendix C: NMI checksum	9
Appendix D: NMI data stream suffix	14
Appendix E: NMI allocation to metering installation types	17
Appendix F: Examples for the allocation of NMIs.....	18

1. Purpose

The purpose of this procedure is to specify the key principles to be adopted by the *Network Operator* for allocation of *NMIs* to *metering installations* in the *NT* electricity supply industry, and the key principles to be adopted by the *Market Operator* for the registration of those *NMIs*.

2. Scope

This document applies to:

- The allocation of *NMIs* to *metering installations* in all electricity supply regions, as well as major and minor centres in the *NT*. The *NMI* is to uniquely identify:
 - a *metering installation* in the network where a meter is used to measure the flow of electricity (either into, across or out of the network);
 - an agreed *metering installation* for non-metered loads that are billed by a retailer to a customer;
- The *I-NTEM* and the *NTEM* (as it is currently understood);
- The initial purpose built settlements system for the *I-NTEM* for its life span;
- The *AEMO* Market Settlements And Transfer Solution ('MSATS') at the time it is introduced into the *I-NTEM* or the *NTEM*.

For the removal of doubt:

- The *UMI* will be superseded by the *NMI* at all customer locations in the *NT*.
- The *NMI* does not uniquely define a *connection point*, even though there are a number of *connection points* with only one *metering installation* and hence one *NMI*.
- There may be more than one *metering installation* at *connection point*, and this principle should be preserved when defining the *NMI* relationship. That is, *NMIs* are not to be allocated solely for the purpose of uniquely identifying network *connection points*.

- If the principle of embedded networks is adopted in the *NT*, the allocation *NMIs* to *metering installations* in that network will follow the principles in this procedure. That is, there will be no unique identifier for the embedded network.

3. Roles and Responsibilities

Role / Title	Responsibility
Senior Executive Manager Commercial and Legal	<ul style="list-style-type: none"> • Approve this procedure. • Ensure that this procedure is complied with during its application.
Senior Manager Wholesale Market Services (Market Operator)	<ul style="list-style-type: none"> • Prepare and maintain the procedure. • Consult on the procedure when it is prepared and at any time it is substantially changed so that the <i>NMI</i> allocation process represents an arrangement agreed by <i>I-NTEM</i> Market Participants and other regional participants. • Implement the procedure in regard to the registration of <i>NMIs</i> against settlement points.
Senior Manager Metering Services (Metering Coordinator)	<ul style="list-style-type: none"> • Implement the procedure to ensure that all <i>metering installations</i> have a <i>NMI</i>, subject to a reasonable plan to transition from the <i>UMI</i> to the <i>NMI</i>.
<i>Stakeholders</i>	<ul style="list-style-type: none"> • Adopt the <i>NMI</i> as the unique reference to a <i>metering installation</i> for the purpose of customer transfers.

4. Definitions

The definitions of words recorded in the Glossary of the System Control Technical Code apply to this document, in addition to the words recorded in the table below, as shown in italics throughout the document.

Word	Definition
<i>AEMO</i>	Australian Energy Market Operator
<i>Connection point</i>	The point at which electricity is transferred to or from an electricity network. A connection point can be an entry point to or an exit point from a network, as defined in the Electricity Networks (Third Party Access) Code.
<i>I-NTEM</i>	Interim Northern Territory Electricity Market. The Electricity Market in the Darwin – Katherine power system that commenced in May 2015.
<i>Market Operator</i>	The <i>NT</i> entity that manages the wholesale exchange of electricity based on the System Control Technical Code. <i>Power and Water</i> is the <i>Market Operator</i> in the <i>I-NTEM</i> .
<i>Metering installation</i>	The assembly of components including the instrument transformer, if any, measurement element(s) and processes, if any, recording and display equipment, communications interface, if any, that are controlled for the purpose of metrology and which lie between the metering point(s) and the point at or near the metering point(s) where the energy data is made available for

Word	Definition
	collection. Notes: (1) The assembly of components may include the combination of several metering points to derive the metering data for a [settlement point at any] connection point. (2) The metering installation must be classified as being for revenue purposes and/or as a check metering installation. (3) An unmetered connection point in accordance with schedule 7.2 does not require a meter; it is nevertheless considered as having a metering installation.
<i>Metering point</i>	The point of physical connection of the device measuring the flow of electricity in the power conductor.
<i>NEM</i>	National Electricity Market
<i>Network Operator</i>	The Power Networks business unit within the Power and Water Corporation for the NT.
<i>NMI</i>	A National Metering Identifier as described in clause 7.3.1(d) of the National Electricity Rules.
<i>NT</i>	Northern Territory
<i>NTEM</i>	Northern Territory Electricity Market – a future upgrade of the <i>I-NTEM</i> market design
<i>Power and Water (PWC)</i>	The Power and Water Corporation
<i>Service point</i>	The physical point of service of a network; a term used interchangeably with the term <i>connection point</i> within the <i>Power and Water</i> enterprise systems.
<i>Stakeholders</i>	<i>Market Participants</i> and <i>System Participants</i>
<i>UMI</i>	The unique identifier assigned to an exit point by a network provider, as stated in the Retail Supply Code. Commonly referred to as the Unique Metering Identifier’.

5. Principles

The following principles are to be used to guide the allocation of the *NMI* in the *NT*:

- 5.1. Source of *NMIs*:
 - 5.1.1. *NMIs* are available as a block from *AEMO* for use in the *NT* (refer to Appendix A ‘*NMI* source’ for details).
 - 5.1.2. The block of numbers is to be assigned by the *Market Operator* to each of the *NT* electricity supply power systems in accordance with the list provided in Appendix A.
- 5.2. The *Network Operator* must issue for each *metering installation* a unique *NMI*. For the removal of doubt:
 - 5.2.1. There may be more than one *metering installation* at any one *connection point*. Consequently, there may be more than one *NMI* at any one *connection point*.
 - 5.2.2. There will only be one *metering installation* at any one settlement point¹. Consequently, there will be a one-to-one relationship between a settlement point and a *NMI*.

¹ A ‘settlement point’ in this paper means the agreed point of supply where electricity is financially transacted between a Retailer and a customer. There may be one or more settlement points assigned to a

- 5.2.3. Any one *metering installation* may be formed from an assembly of the components from two or more standalone *metering installations*.
- 5.3. The *NMI* is to be allocated to the following *metering installations*:
- 5.3.1. *Metering installations* that contain interval meters.
- 5.3.2. *Metering installations* that contain accumulation meters.
- 5.3.3. *Metering installations* that do not contain a meter but are to be used in the wholesale settlements process (for example, street lights).
- 5.3.4. *Metering installations* at wholesale market boundary points.
- 5.3.5. *Metering installations* at customer settlement points.
- 5.3.6. *Metering installations* in embedded networks.
- 5.4. The *Network Operator* must register each *metering installation* (and its *NMI*) that has been allocated to a generator, a retailer or a customer with the *Market Operator*.
- 5.4.1. The following information must be provided to the *Market Operator*:
- (a) *NMI*;
- (b) Address, including street identifiers and postcode;
- (c) The identity, characteristics and serial numbers of the *metering installation* components² (such as meter, instrument transformers, modem);
- (d) Loss Factor Code;
- (e) Embedded network parent and child names (if any);
- (f) Network node identifier (being: generator, bulk settlement point or customer, as the case may be).
- 5.4.2. For the removal of doubt, Power Networks within *PWC* will perform the following roles in the *NT*. This information is not required to be recorded against the *metering installation* at the time of registration:
- (a) Metering Coordinator.
- (b) Metering Provider.
- (c) Metering Data Provider.
- 5.5. *NMI* structure. The *NMI* is a basic ten numeric digit number. The *NMI* may be used in conjunction with other identifiers or suffixes, which are explained in Appendix B '*NMI Structure*'.
- 5.6. *NMI* checksum. A one digit checksum feature must be used to reduce the occurrence of incorrect transfers attributable to manual data entry errors. This feature is explained in Appendix C '*NMI checksum*'.
- 5.7. *NMI* data stream suffix. From any one *metering installation* there could be multiple data streams³. The number of data streams at a *connection point* increases when multiple *metering installations* are registered at that location. The accurate identification of data streams is explained in Appendix D '*NMI data stream suffix*'.
- 5.7.1. For the purpose of assigning the correct characters for import and export to a *NMI* suffix, the energy flow directions are to be followed⁴:

connection point. It is used in this paper to emphasise the difference between the purpose of a *metering installation* and the purpose of a *connection point*.

² As determined by the Market Operator from time to time.

³ For example, import and export data streams for both kWh and KVARh.

⁴ A diagrammatic representation of this principle can be found in Section 15 of the AEMO *NMI Procedure*.

- (a) Import is where electricity enters a network, either from a source of generation or from another network – it is assigned the first suffix character B.
 - (b) Export is where electricity exits a network, either to a load or to another network – it is assigned the first suffix character E.
- 5.8. *NMI* allocation at the wholesale market boundary⁵. At the boundary between the wholesale market network and a distribution network, there are two different types of settlement point. One is a physical point and the other is a virtual point⁶.
- 5.8.1. The physical settlement point must have a physical *metering installation*, and hence a *NMI*.
 - 5.8.2. The virtual settlement point will be established by the *Market Operator* to allow a customer's *metering installation* to be referred to that point (under certain circumstances⁷) for the purpose of settlements. A virtual settlement point will also be assigned a *NMI*, which is different to that assigned to the physical *metering installation*.
 - 5.8.3. The *Market Operator* will request the *Network Operator* to allocate a *NMI* to the *metering installation* that will be assigned to the virtual settlements point.
- 5.9. *NMI* allocation to *metering installation* types. *NMIs* are to be allocated differently in accordance with the requirement to use check *metering installations* in certain situations. The treatment of *NMIs* when both master and check *metering installations* are deployed are explained in Appendix E '*NMI* allocation to *metering installation* types'.
- 5.10. *NMI* rules. The following rules are to apply to the use of a *NMI*:
- 5.10.1. The *Network Operator* must register the basic ten digit *NMI* with the *Market Operator*.
 - 5.10.2. The Metering Data Provider must add appropriate identifiers to the end of the *NMI* (suffix) to enable the *Market Operator* to identify the characteristics of the data stream collected from any one meter. These identifies are explained in Appendix D '*NMI* data stream suffix'.
 - 5.10.3. Whilst a customer may elect to change its retailer, the *NMI* at the settlements point remains assigned to the *metering installation*.
 - 5.10.4. Whilst a customer may move in and out of a premise that contains a *NMI*, there will be no change to that *NMI* at that premise.
 - 5.10.5. A *NMI* cannot be assigned to another settlement point, other than for the following conditions:
 - (a) When a *NMI* is assigned to a builder's temporary supply, the *NMI* may be re-used on the permanent supply once the building work has been completed.
 - (b) If there is a consolidation of metering (eg. change from 3 meters to 2 meters) or a relocation of the meter box without changes to the location of the measurement transformers the *NMI* will remain unchanged.
 - (c) A reconstruction of the customer service connection (eg. overhead changed to underground) in which the two services are not concurrently operational, and without a change of the *connection point* to the network, does not require a change of *NMI*.

⁵ The wholesale market boundary is the set of agreed points of supply that distinguish the interface between the wholesale market and the rest of the market, being the points of supply that are utilised by the *Market Operator* for settlements of the *I-NTEM* and the *NTEM* in accordance with the System Control Technical Code.

⁶ Also known as 'logical' in the *NEM*.

⁷ This will be activated if the *I-NTEM* (or subsequent design changes) adopts the settlements by differences technique used by the *NEM* for transacting metering data in the market.

- 5.10.6. All communications to and from Market Participants and the Metering Coordinator must include the *NMI*.
- 5.10.7. Transfer of all meter data to the *Market Operator* must be in an agreed format that includes NMI identification.
- 5.11. Examples for the allocation of NMIs are explained in Appendix F 'Examples for the allocation of *NMIs to interval meters*'.

6. References

#	Document	Date	Location
1	Systems Control Technical Code v5 (2015)	23/05/2016	D2015/414673
2	NMI Procedure (<i>NEM</i>)	August 2009	AEMO website
3	NMI Allocation List, v8 (<i>NEM</i>)	December 2014	AEMO website
4	Retail Supply Code	1 June 2013	UC Website
5	Electricity Networks (Third Party Access) Act	1 July 2015	UC Website

7. Appendices

- 7.1. Appendix A: *NMI* source.
- 7.2. Appendix B: *NMI* structure.
- 7.3. Appendix C: *NMI* checksum.
- 7.4. Appendix D: *NMI* data stream suffix.
- 7.5. Appendix E: *NMI* allocation to metering installation types.
- 7.6. Appendix F: Example for the allocation of *NMIs*.

8. Records

This procedure is to be stored in Power and Water’s Records Management System (TRIM) in accordance with the Document and Record Control Procedure.

9. Review

This document is to be reviewed no later than three years, or more frequently as required by the *Market Operator*.

10. Document History

Date of Issue	Version	Prepared By	Description of Changes
07/03/2016	V01	Phacelift	Initial version for consultation
23/05/2016	V1.0	Jodi Triggs	Approved version following consultation. Minor change made to Appendix A for on-grid IES meters NMI block per power system.

For clarification on the use of this document, please contact:
 Jodi Triggs
 Power and Water Corporation in the role of Market Operator
 Phone: 08-8985-8456
 Email: market.operator@powerwater.com.au

Appendix A: NMI Source

A *NMI* is a basic ten digit number that can be expanded by adding designated suffixes to identify specified characteristics of the data streams within the *metering installation*.

AEMO has assigned the following series of numbers ('block') to the *NT* for use as *NMIs*⁸:

First *NMI* in the block: 2500000000

Last *NMI* in the block: 2509999999

The *Market Operator* is the custodian of this block of numbers.

The *Market Operator* has determined to assign the *NMI* block across the *NT* in the following way:

Darwin – Katherine power system:	2500000000 to 2500999999
Alice Springs power system:	2501000000 to 2501999999
Tennant Creek power System:	2502000000 to 2502999999
Yulara power system:	2503000000 to 2503999999
Kings Canyon:	2504000000 to 2504999999
Timber Creek:	2505000000 to 2505099999
Elliott:	2505100000 to 2505199999
Borrooloola:	2505200000 to 2505299999
Daly Waters:	2505300000 to 2505399999
Ti Tree:	2505400000 to 2505499999
Nhulunbuy:	2506000000 to 2506099999
Alyangula:	2506100000 to 2506199999
Jabiru:	2506200000 to 2506299999
IES non-grid connected:	2507000000 to 2507999999
Other:	2508000000 to 2509999999

Note: in each of the above series of numbers, the following protocol is to be adopted in allocating *NMIs* to the wholesale market boundary and street lights.

- (a) Wholesale market boundary: The first 1,000 numbers in the series is to be allocated to the wholesale market boundary *metering installations*. For example, in the Darwin – Katherine power system the group of numbers between and including 2500000000 and 2500001000.
- (b) Street lighting: The last 10,000 numbers in the series is to be allocated to street lighting *metering installations*. For example, in the Darwin – Katherine power system the group of numbers between and including 2500999000 and 2500999999.
- (c) IES grid connected customers: The block of 10,000 numbers that commence at 1,001 in the series is to be allocated to the IES grid connected customer *metering installations*. For example, in the Darwin – Katherine power system the group of numbers between and including 2500001001 and 2500001100.

⁸ See 'NMI Allocation List, v8' on the AEMO website.

Appendix B: NMI Structure

The base *NMI* is ten characters. In some circumstances the *NMI* checksum is appended to the *NMI* to form an eleven-character *NMI*, or the two character *NMI* data stream suffix may be appended to form a twelve-character *NMI*.

The *NMI* checksum is not used with the data stream suffix because the data stream suffix is intended for use only with electronic data transfer, whereas the *NMI* checksum is intended for use during manual entry of data.

The key attributes of the *NMI* are:

- The *NMI* must embody only numeric characters, except as explicitly provided within this document, and must not contain spaces.
- Character letters 'O' and 'I' are not permitted in order to avoid confusion with numbers 0 and 1.
- Embedded characters or meanings should not be used in allocating *NMIs*.
- The *Network Operator* must:
 - only use the *NMIs* obtained from the *Market Operator*.
 - allocate a unique *NMI* to each *metering installation* in the *NT* for which it is responsible.
 - Not re-use a *NMI* that has been allocated to a *metering installation* when that installation is no longer active (or 'on-market').
 - maintain a register of all *NMIs* allocated to *metering installations*.
- The *Market Operator* must maintain a register of all 'on-market' *NMIs* within its market systems.

The relationship between the defined points at the boundary of a network is shown in diagram B1:

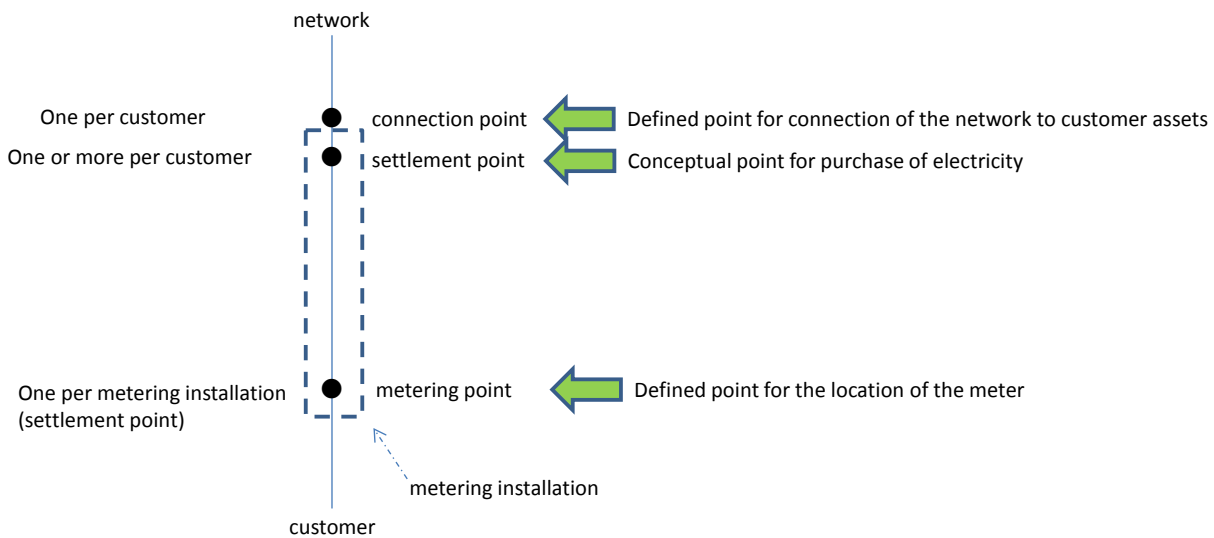

Diagram B1 – relationship between defined points at a network boundary

In the diagram the customer is responsible for the electricity used beyond the *connection point*. Consequently, the settlement point should be shown co-incident with the *connection point*. However, for visualisation purpose, the settlement point is shown below the *connection point*, and is used as a means of conceptualising the difference between the *connection point* and the impact of the *metering installation*. The *metering installation* includes the *metering point* and the losses between the *metering point* and the *connection point*, as shown by the dashed box.

Appendix C: NMI checksum

To reduce the occurrence of incorrect transfers attributable to *NMI* data entry errors, a one digit checksum has been implemented. The *NMI* checksum is a single numeral used to assist with data validation when the *NMI* is manually entered into a computer system. The *NMI* checksum is not used in conjunction with the *NMI* data stream suffix. However, when publishing a *NMI* for end-use customers the *NMI* will appear in its 11 character format, and the checksum will be the final character of the *NMI*.

The *NMI* checksum is a mandatory field whenever a *NMI* is manually entered into the Market Operator's relevant market system.

Sample java code for an implementation of the checksum is provided in C1 below.

A general form of the algorithm used to create the NMI checksum is:

1. Double the ASCII value of alternate digits within the *NMI* beginning with the right-most digit.
2. Add the individual digits comprising the products obtained in step 1 to each of the unaffected ASCII value digits in the original number.
3. Find the next highest multiple of 10.
4. The check digit is the value obtained in step 2 subtracted from the value obtained in step 3.
5. If the result of this subtraction is 10 then the check digit is 0.

A worked example of the algorithm is provided in C2 below.

The *NMI* checksum is always a numeric character.

The *NMI* checksum is not mandatory when transferring *NMI* identified data electronically between Participants and service providers. The checksum is focussed on applications where data entry occurs and there is a risk of character transposition, for example from paper to electronic systems or through an interactive telephone service.

C1: Sample java code for the NMI checksum:

```
/**
 * Calculates a LUHN-10.
 * <PRE>
 * 1. Double the value of alternate digits beginning with the rightmost digit
 * 2. Add the individual digits comprising the products obtained in step 1 to
 *   each of the unaffected digits in the original number.
 * 3. Find the next highest multiple of 10
 * 4. The check digit is the value obtained in step 2 subtracted from the value
 *   obtained in step 3.
 * 5. END
 * </PRE>
 */ public class LUHN10 {
/**
 * Value to indicate we have not calculated the luhn yet.
 */
private static final int NULL_VALUE = -1;
/**
```

```
* Buffer holding the sequence of digits to use in the calculation.
*/
private StringBuffer _buffer;
/**
 * The cached value for the luhn.
 */ private int _luhn;
/**
 * Constructor.
 */
public LUHN10()
{
    reset();
}
/**
 * Resets the calculator to its initial values.
 */ public void reset()
{
    _buffer = new StringBuffer();
    _luhn = NULL_VALUE;
}
/**
 * Updates the LUHN-10 with specified digit.
 */ public void update(char d)
{
    // Append the character
    _buffer.append(d);
    // And, reset the cached luhn
    _luhn = NULL_VALUE;
}
/**
 * Returns the current LUHN-10 value.
 */
public int getValue()
{
    if (_luhn == NULL_VALUE)
    {
        int v = 0;
        boolean multiply = true;
        for (int i = _buffer.length(); i > 0; i--)
        {
            int d = (int)_buffer.charAt(i - 1);
```

```
    if (multiply)
    {
        d *= 2;
    }
    multiply = !multiply;
    while (d > 0)
    {
        v += d % 10;
        d /= 10;
    }
}
_luhn = (10 - (v % 10)) % 10;
}
return _luhn;
}
public static void main(String[] args)
{
    if (args.length == 0)
    {
        System.out.println("USAGE: LUHN10 nmi");
    }
    else
    {
        LUHN10 luhn = new LUHN10();
        String nmi = args[0];
        for (int j = 0; j < nmi.length(); j++)
        {
            luhn.update(Character.toUpperCase(nmi.charAt(j)));
        }
        System.out.println(nmi + "/" + luhn.getValue());
    }
}
}
```

C2: Worked example of the NMI checksum java code:

This following worked example demonstrates the *NMI* checksum calculation. The logic of the algorithm can be summarised as:

- Process each character in the NMI individually, starting with the right most.
- For each character:

- Convert the character to its ASCII value
- For the right most character and each alternate character reading left, double the ASCII value obtained in Step 3 above.
- Add the individual digits of the ASCII value to a register holding the total added value for the Checksum.
- Subtract the total added value register from the next highest multiple of 10.
- If the result is 10, the checksum is 0, otherwise the result is the checksum.

The *NMI* for the following worked example is 1234567890

Step 1. Initialise variables used by the process.

Double_This_Char is a boolean that indicates whether the character currently being processed should be doubled.

Char is the character currently being processed, as it appears in the *NMI*.

ASCII_Char is the ASCII value of **Char**

Total is the running sum of the digits generated by the algorithm.

Checksum is the final result.

At the start of the process: **Double_This_Char** = True because the right most character, and then every alternate character, is doubled by the algorithm. **Total** = 0 **Checksum** = NULL

Step 2. Read the *NMI* character by character, starting with the right most character.

Char = 0 [TotalBefore]

Step 3. Convert the character to its ASCII value.

ASCII_Char = 48

Step 4. Double the ASCII value if the character is the right most of the *NMI* or an alternate.

ASCII_Char = 96

Double_This_Char = Not Double_This_Char

Step 5. Add the individual digits of the ASCII value to the Total.

Total = TotalBefore + 9 + 6 (i.e. Total = 15)

Performing steps 2 through 5 for each character in our example NMI gives the following results:

Character	Total Before	ascii value	Double?	Doubled Value	Total After
0	0	48	Y	96	15 (0+9+6)
9	15	57	N	57	27 (15+5+7)
8	27	56	Y	112	31 (27+1+1+2)
7	31	55	N	55	41 (31+5+5)
6	41	54	Y	108	50 (41+1+0+8)
5	50	53	N	53	58 (50+5+3)
4	58	52	Y	104	63 (58+1+0+4)
3	63	51	N	51	69 (63+5+1)
2	69	50	Y	100	70 (69+1+0+0)
1	70	49	N	49	83 (70+4+9)

Table C1: Example for NMI 1234567890

The value of **Total** after processing the entire *NMI* is 83.

The next highest multiple of 10 is 90.

Checksum = 90 – 83 = 7.

Appendix D: NMI data stream suffix

Settlement of the *I-NTEM* and other regions is reliant on the collection and delivery of metering data from initially ~3,000 *metering installations*, with the total rapidly growing up to ~100,000 *metering installations* as accumulation meters are converted to interval meters.

For any particular *metering installation* (and hence a given *settlement point* and *connection point*) there may be multiple energy measurement elements and data recorders with multiple channels. Accurate identification of data streams is essential. The data stream suffix provides identification at the measurement element level for all data streams comprising the *metering installation* identified by the *NMI*.

The data stream suffix is a two character identifier used in conjunction with a ten digit *NMI* to identify a particular data stream associated with that *NMI* (making 12 characters in total). The data stream suffix allows differentiation of measurement quantities at a *metering point*, and differentiation of quantities between different measurement elements or registers for a *metering installation* at its *settlement point* and *connection point*.

A twelve character *NMI* string identifies the *metering installation* (first ten characters) and associated data stream (data stream suffix as the last two characters).

The data stream suffix has retained alpha numeric characters because an all numeric structure could not accommodate the variety of data types or number of meters which may be required for the *metering installation*.

The data stream suffix is used when transmitting data between the *Market Operator*, *Market Participants* and the Metering Data Provider within the *NT* – it is not used in conjunction with the *NMI* checksum. The data stream suffix allows the parties to identify data at a sub-*connection point* level and to identify the individual sources of meter data to maintain necessary data audit trails.

The following two sections and tables detail the usage of the characters comprising the data stream suffix.

Interval Metering Data

Interval Metering Data is metering data in trading intervals or sub-intervals of trading intervals. It may be sourced from *metering installations* type 1 to 5 or 7. Metering data from a type 6 *metering installation* which has been transformed through a profiling algorithm into trading intervals is also identified as interval metering data (such as is performed for the IES Communities where there is no statistical bulk meter at the entrance of the community).

Interval metering data is identified in the data stream suffix by a suffix first character that is alpha [A to H, J to N, P to Z].

Identifiers in the MASTER column are those used within the *NEM* – they will be utilised for the *I-NTEM*. Where check metering is required (type 1 & 2 *metering installations*), identifiers from the CHECK column are used for the check installation.

Where the data from the MASTER and CHECK installations has been averaged (due to the *metering installations* being identical) the AVE column identifiers are used. Where only the difference between import and export is required, the NET column identifiers are used.

NET data is not to be used in the *I-NTEM*, as the contributions from both import and export to the market are required for policy analysis.

Data stream	First Character				Second character
	AVE	MASTER	CHECK	NET	
Import kWh	A	B	C	N	Meter numbers or measuring elements are to be 1–9 then A–H, J–N, P–Z
Export kWh	D	E	F		
Import kAVrh	J	K	L	X	
Export kVArh	P	Q	R		
KVAh	S	T	U		
Power Factor Pf		G			
Q metering Qh		H	Y		
Par metering path		M	W		
Volts (or V ² h) or Amps (A ² h)		V	Z		

Table D1: data stream suffices for interval metered data

Where a meter has multiple measurement elements, the convention for the population of the second character of the data stream suffix is:

- Increment the second character by one if the first character is the same. For example, use E1 and E2 if both elements are export kWh, and B1 and B2 if they are both import kWh. Use the same second character if the first character is different. For example, use E1 and B1 if they are export kWh and import kWh respectively.
- Example: 2500010101 E2 relates to Export kWh data from either meter no.2 (single element) or element 2 of meter no.1 (twin element) pertaining to the connection point having the assigned NMI of 2500010101. Refer to Appendix F1.4 & 1.5 for diagrammatic examples.

Accumulation Energy Data

Refer to the Table below:

If the first character of the data stream suffix is numeric [1 to 9] the attached data is accumulation energy data from a type 6 *metering installation*.

The data streams identified by characters 1 to 6 are active energy (kWh). Data streams identified with 7, 8, or 9 are as defined by the *Network Operator*.

Suffix	Register Description	Meter number
1	First register	Meter numbers are to be 1–9 then A–H, J–N, P–Z.
2	Second register	
3	Third register	
4	First control load register	
5	Second control load register	
6	Third control load register	
7	First <i>Network Operator</i> defined register	
8	Second <i>Network Operator</i> defined register	
9	Third <i>Network Operator</i> defined register	

Table D2: Data Stream suffixes for consumption energy data

Examples:

- 2500012345 1A relates to accumulation energy data from meter A (the 10th meter at the installation), register 1 applicable to a *metering installation* with the *NMI* of 2500012345.
- 2500012346 43 relates to accumulation energy data from a controlled circuit register in the 3rd meter at the installation, the data pertaining to a *metering installation* with the *NMI* of 2500012346.

Appendix E: NMI allocation to metering installation types

In the *NT*, the following situations provide insight into the allocation of *NMIs* for the types of *metering installation* to be deployed:

Power stations:

The largest annual flow of electricity is measured at the Channel Island power station. In 2015, the quantity was ~80,000 MWhs (80 GWh). This quantity was shared by three line *metering installations*, one of which was close to a balanced (zero) flow for the year. Accordingly, and assuming that the remaining two *metering installations* measured equal portions, the maximum flow for each *metering installation* would be ~40 GWh. This quantity equates to a type 3 *metering installation*.

Generators whose annual electricity volume per *metering installation* is less than 100 GWh but equal to or more than 0.75 GWh (750 MWh) are subject to type 3 *metering installation* accuracy. There is no requirement to provide a check metering (or partial check metering) arrangement for this volume range. Consequently, a single *NMI* will be allocated to this *metering installation*.

Zone Substations:

The largest zone substation in the Darwin – Katherine power system has a capacity of 25 MW. At a load factor of 60% and two transformers, each with a *metering installation*, one of those *metering installations* would measure 66 GWh for a year, determined as follows:

$$\begin{aligned}\text{Annual flow of electricity through one } \textit{metering installation} &= 25/2 * 8,760 * 60\% / 1000 \text{ GWh} \\ &= 66 \text{ GWh}\end{aligned}$$

This quantity requires a type 3 *metering installation* per transformer. An annual volume of less than 100 GWh but equal to or more than 0.75 GWh requires only one master (revenue) *metering installation*. The *metering installation* would have a unique *NMI*.

As the annual volume per transformer is determined to be less than 100 GWh no requirement for a check metering arrangement is required.











Customers below 100 GWh:

For the full range of customers whose annual electricity volume is less than 100 GWh (down to zero MWh) there is no requirement to provide a check (or partial check) arrangement. Consequently, a single *NMI* will be allocated to this *metering installation*.

Appendix F: Examples for the allocation of NMIs

There are two categories of example; one for interval *metering installations* (section F1) and one for accumulation *metering installations* (section F2).

The following legend is deployed throughout the examples:

-  connection point
-  settlement point
-  transformer
-  meter
-  twin element meter, each element having its own register
-  Two register meter with single measurement element
-  Open switch
-  circuit breaker
-  Closed switch
-  metering installation (in part)

F1 – examples for interval metering installations

F1.1 Contestable customer, metered on the lower voltage side of the transformer

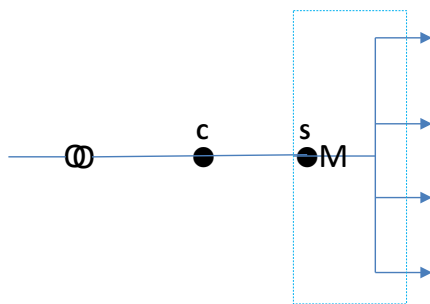

Attributes:

- One *connection point*
- One *settlement point*
- One *metering installation*
- One meter (single measurement element)
- One *NMI*
- Allocated *NMI*: 2500010101
- Identity of collected meter data stream: 2500010101 E1

F1.2 Contestable customer, multiple metered on the lower voltage side of the transformer

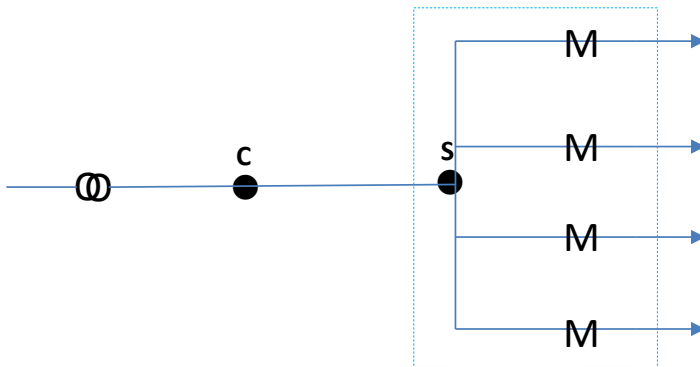

Attributes:

- One customer
- One *connection point*
- One *settlement point*
- One *metering installation*
- Four meters (each with a single measurement element)
- One *NMI*
- Allocated *NMI*: 2500010101
- Identity of collected meter data streams: 2500010101 E1
2500010101 E2
2500010101 E3
2500010101 E4

F1.3 Contestable customer, two tariff metering (general supply + off-peak) on the lower voltage side of the transformer

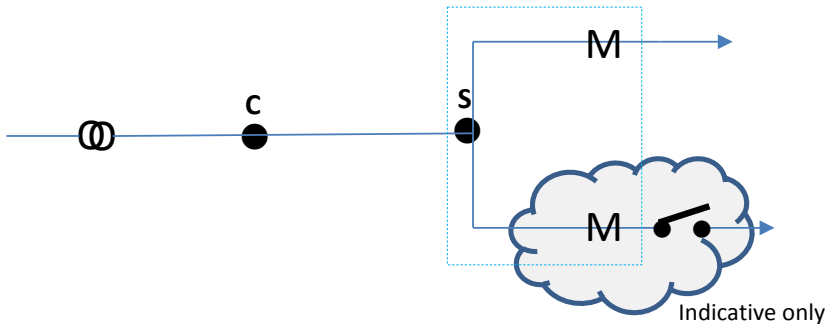

Attributes:

- One customer
- One *connection point*
- One *settlement point*
- One *metering installation*
- One meter (single element) – no load control device
- One meter (single element) with a controlled load
- One *NMI*
- Allocated *NMI*: 2500010101
- Identity of collected meter data streams: 2500010101 E1
2500010101 E2

F1.4 Contestable customer, two controlled loads, one twin element meter

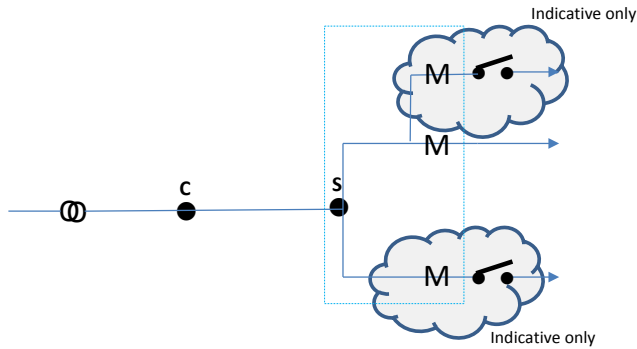

Attributes:

- One customer
- One *connection point*
- One *settlement point*
- One *metering installation*
- One meter (twin element) with a controlled load
- One meter (single element) with a controlled load
- One *NMI*
- Allocated *NMI*: 2500010101
- Identity of collected meter data streams: 2500010101 E1
2500010101 E2
2500010101 E3

F1.5 Contestable customer, two twin element meters

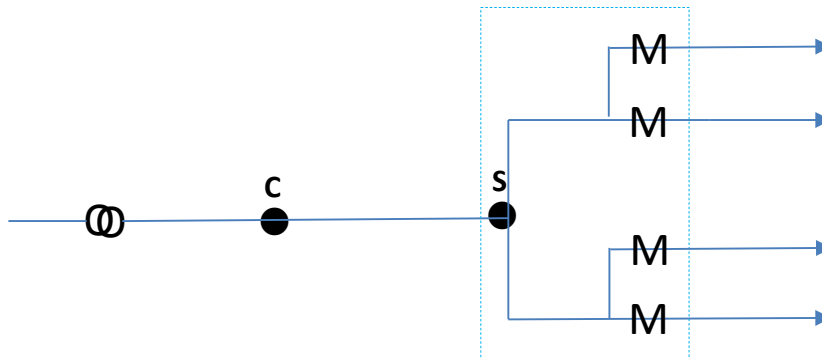

Attributes:

- One customer
- One *connection point*
- One *settlement point*
- One *metering installation*
- Two meters (each with twin elements)
- One *NMI*
- Allocated *NMI*: 2500010101
- Identity of collected meter data streams: 2500010101 E1
2500010101 E2
2500010101 E3
2500010101 E4

F1.6 Contestable customer, multiple meters on low voltage side of multiple transformers in the same substation

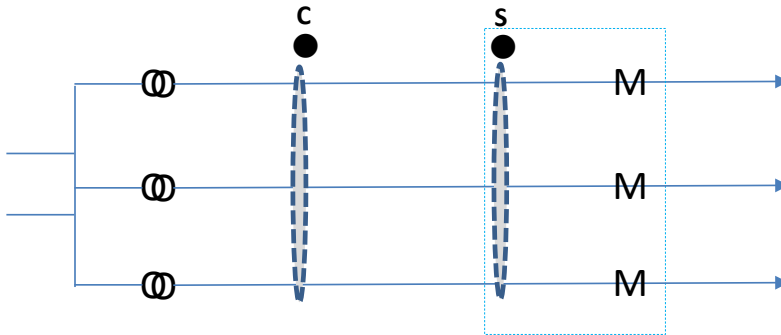

Attributes:

- One customer
- One *connection point* across three circuits
- One *settlement point* across three circuits
- One *metering installation* across three circuits
- Three meters (each with a single element)
- One *NMI*
- Allocated *NMI*: 2500010101
- Identity of collected meter data streams: 2500010101 E1
2500010101 E2
2500010101 E3

F1.7 Three contestable customers, metered on low voltage side of multiple transformers in the same substation building

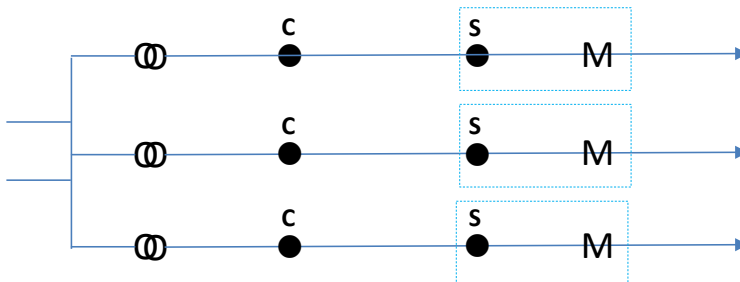

Attributes:

- Three customers
- Three *connection points*
- Three *settlement points*
- Three *metering installations*
- One meter (single element) per connection
- Three *NMIs*
- Allocated *NMIs*: 2500010101
2500010102
2500010103
- Identity of collected meter data streams: 2500010101 E1
2500010102 E1
2500010103 E1

F1.8 Two contestable customers, two separate HV supplies to two separate substations, both metered on LV side

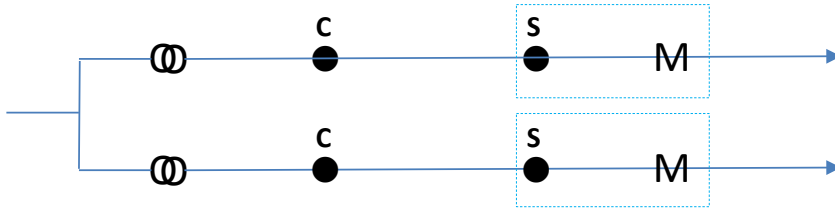

Attributes:

- Two customers
- Two *connection points*
- Two *settlement points*
- Two *metering installations*
- One meter (single element) per connection
- Two *NMIs*
- Allocated *NMIs*:

2500010101	
2500010102	
- Identify of collected meter data streams:

2500010101	E1
2500010102	E1

F1.9 One contestable customer, two separate substations adjacent to each other or one single substation with two separate transformers, with a normally open point separating the high voltage supplies into two sources

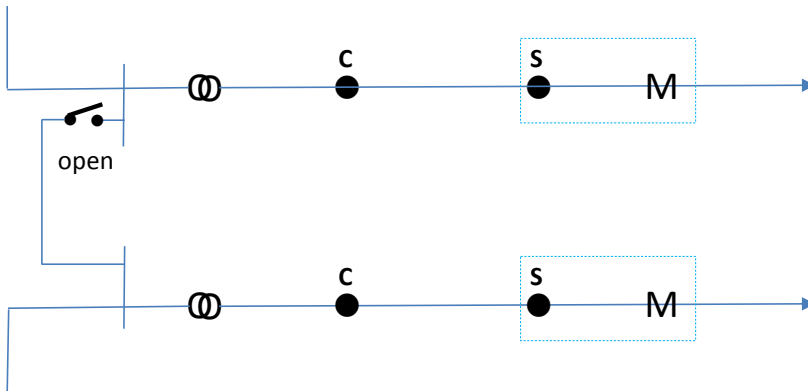

Attributes:

- One customer
- Two *connection points*
- Two *settlement points*
- Two *metering installations*
- One meter (single element) per connection
- Two *NMIs*
- Allocated *NMIs*:

2500010101	
2500010102	
- Identify of collected meter data streams:

2500010101	E1
2500010102	E1

F1.10 One contestable customer, two separate substations adjacent to each other or one single substation with two separate transformers, with the HV supply originating from a single source and LV switchboard in common switch room. This arrangement also applies to two separate substations not adjacent to each other but on the same premise (Eg: Darwin Casino LV supply)

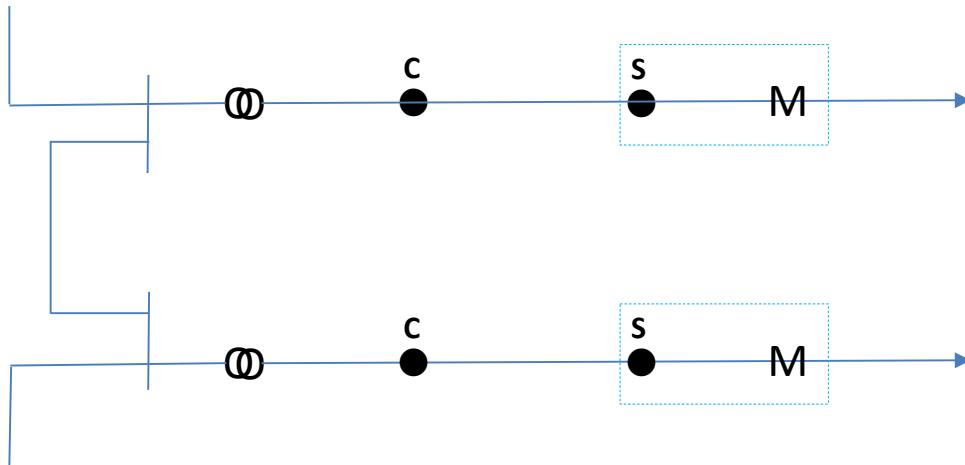

Attributes:

- One customer
- Two *connection points*
- Two *settlement points*
- Two *metering installations*
- One meter (single element) per connection
- Two *NMIs*
- Allocated *NMIs*:

2500010101	
2500010102	
- Identity of collected meter data streams:

2500010101	E1
2500010102	E1

F1.11 Multiple contestable customers, high rise buildings

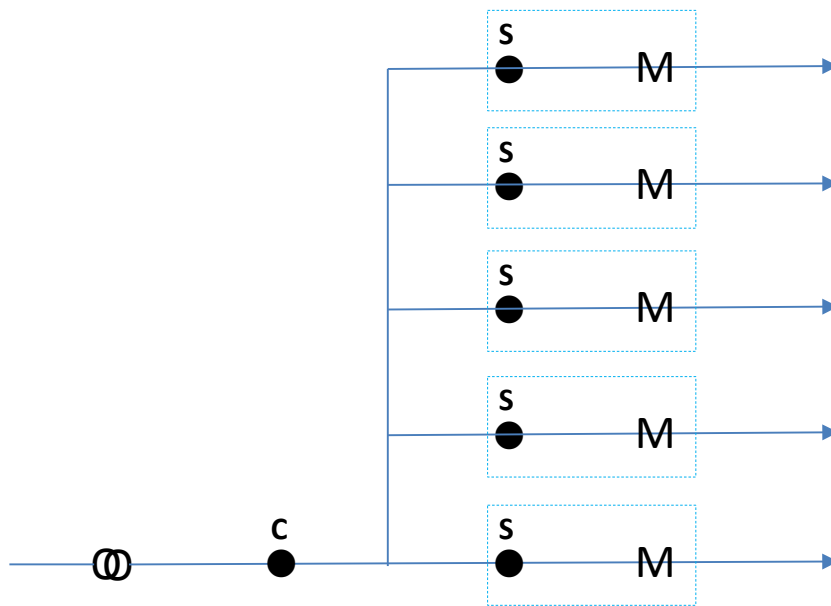

Attributes:

- Five customers
- One *connection point*
- Multiple *settlement points*
- Five *metering installations*
- One meter (single element) per installation
- Five *NMIs*
- Allocated *NMIs*:

2500010101
2500010102
2500010103
2500010104
2500010105
- Identity of collected meter data streams:

2500010101	E1
2500010102	E1
2500010103	E1
2500010104	E1
2500010105	E1

F1.12 Multiple contestable customers, high rise buildings

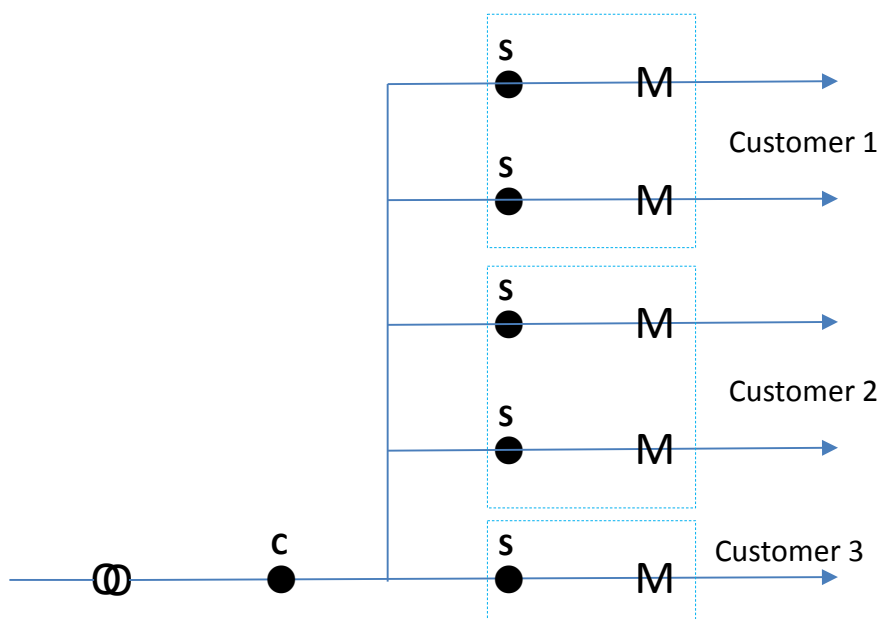

Attributes:

- Three customers
- One *connection point*
- Three *settlement points*
- Three *metering installations*
- One and two meters (single element) per installation
- Three *NMIs*
- Allocated *NMIs*:

2500010101
2500010102
2500010103
- Identity of collected meter data streams:

2500010101	E1
2500010102	E2
2500010103	E1
2500010104	E2
2500010105	E1

F1.13 One contestable customer with multiple supplies (eg: NT Casino HV and LV supply)

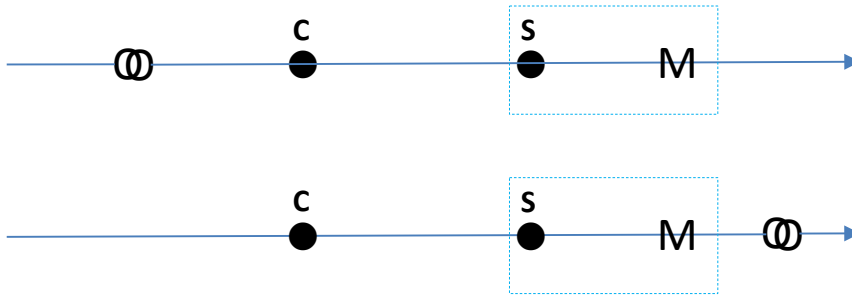

Attributes:

- One customer
- Two *connection points*
- Two *settlement points*
- Two *metering installations*
- One meter (single element) per installation
- Two *NMIs*
- Allocated *NMIs*:

2500010101
2500010102
- Identity of collected meter data streams:

2500010101 E1
2500010102 E1

F1.14 One contestable customer with standby supply (eg: Robertson Barracks, Darwin Airport HV supply)

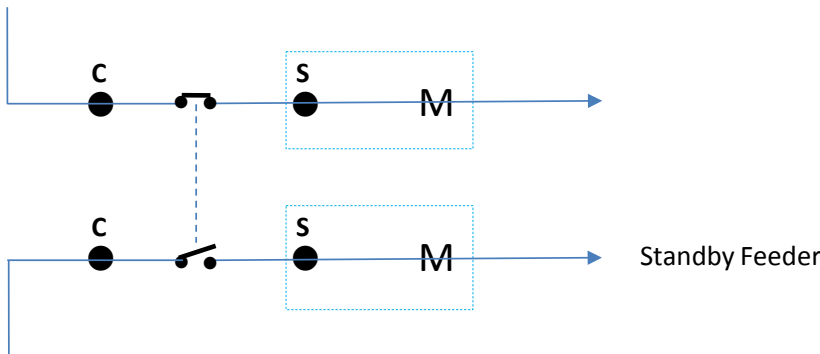

Attributes:

- One customer
- Two *connection points*
- Two *settlement points*
- Two *metering installations*
- One meter (single element) per installation
- Two *NMIs*
- Allocated *NMIs*:

2500010101
2500010102
- Identity of collected meter data streams:

2500010101 E1
2500010102 E1

Note: the 'standby supply may be a second or more permanently closed supply, implying that each supply will have its own *NMI*

F1.15 Wholesale market boundary – physical metering

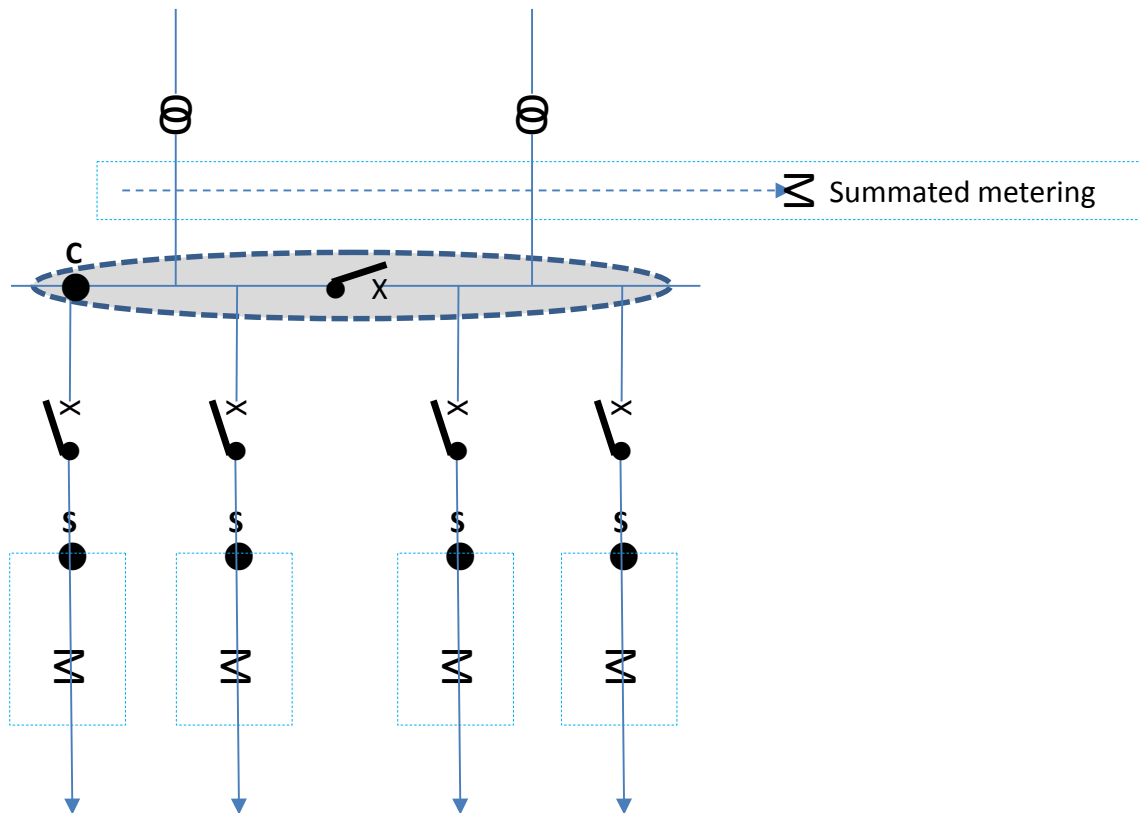

Attributes:

- One Market Participant or customer
- One *connection point*
- Four *settlement points*
- Five *metering installations* (including one check metering installation)
- One meter (single element) per installation
- Five *NMIs*
- Allocated *NMIs*:

2500010101
2500010102
2500010103
2500010104
2500010105
- Identity of collected meter data streams:

2500010101	E1
2500010102	E1
2500010103	E1
2500010104	E1
2500010105	F1

F1.16 Wholesale market boundary – virtual metering

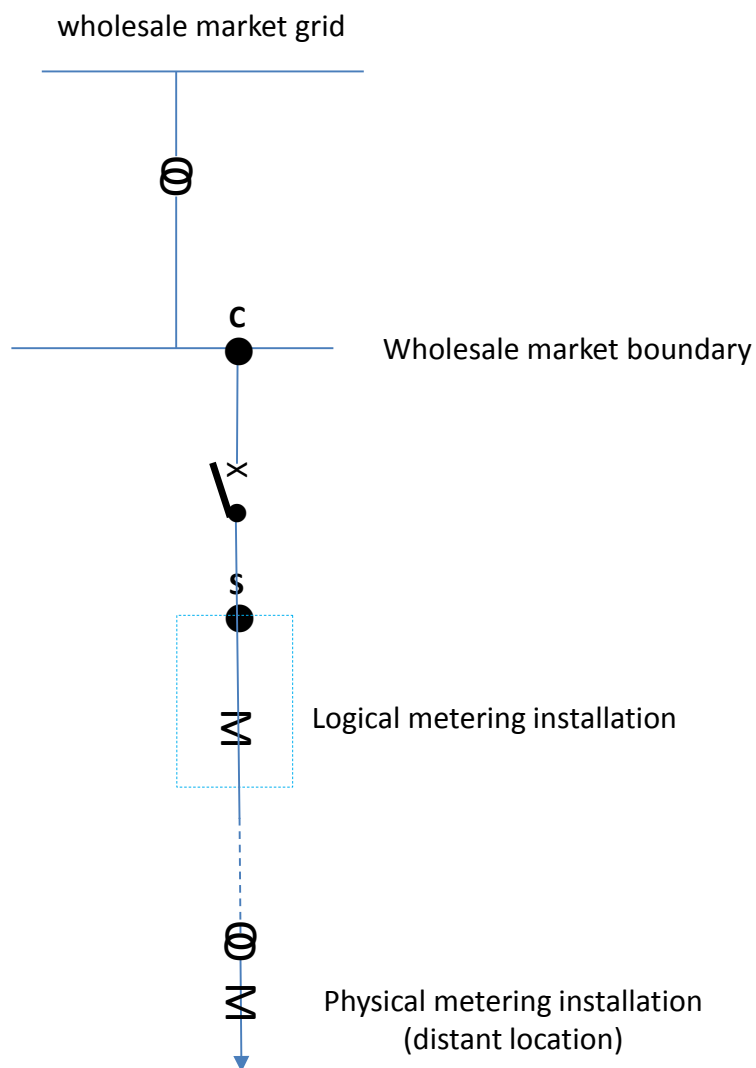

Attributes:

- One Market Participant or customer
- One *connection point*
- One *settlement point* (logical)
- One *metering installation*
- One physical meter (single element) at distant location
- One logical meter (at wholesale boundary)
- Two *NMIs*
- Allocated *NMIs*:

	2500010101
	2500010102
- Identity of collected meter data streams:

2500010101	E1
2500010102	E1

The logical meter corrects the physical meter for line losses.

F1.17 Generating unit supply point at wholesale market boundary

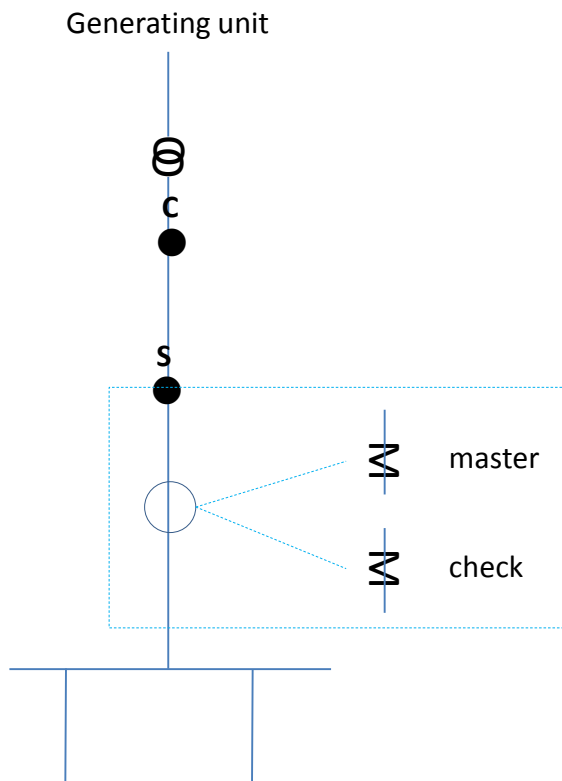

Attributes:

- One Market Participant
- One *connection point*
- One *settlement point* (logical)
- Two *metering installation*s (type 1)
- Two meters (single element), one for revenue and one for check
- Two *NMIs*
- Allocated *NMIs*: 2500010101
- Identity of collected meter data streams: 2500010101 B1 (master)
2500010101 C1 (check)

F1.18 Street lighting (type 7 metering installation)

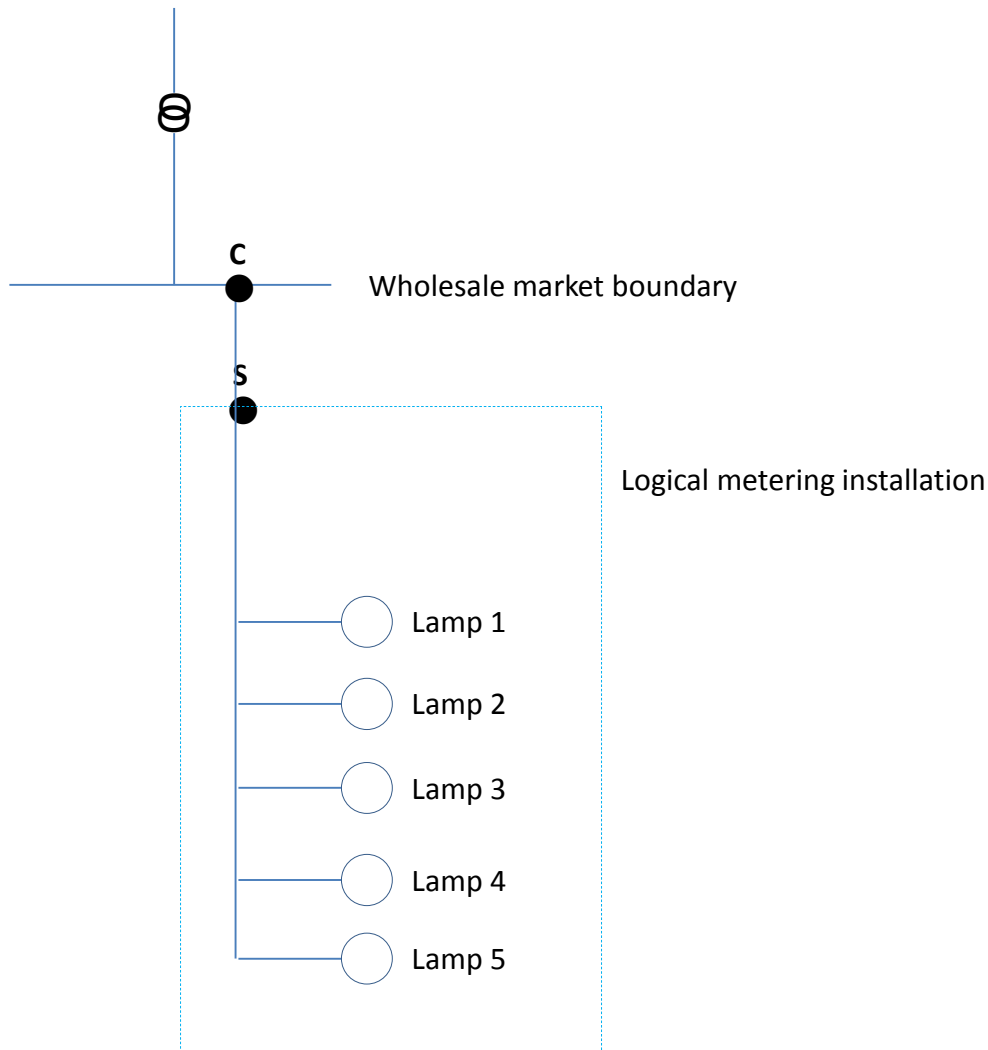

Attributes:

- One customer
- One *connection point*
- One *settlement point* (logical)
- One *metering installation s*(type 7)
- No meters (algorithm used in place of meters)
- One *NMI*
- Allocated *NMI*: 2500010101
- Identity of collected meter data streams: 2500010101 E1

F2 – examples for accumulation metering installations (type 6)

F2.1 One customer, single meter with single register

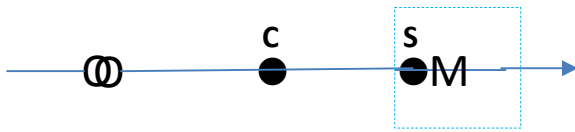

Attributes:

- One *connection point*
- One *settlement point*
- One *metering installation*
- One meter (single measurement element)
- One *NMI*
- Allocated *NMI*: 2500010101
- Identity of collected meter data stream: 2500010101 11

F2.2 One customer, two meters with single register

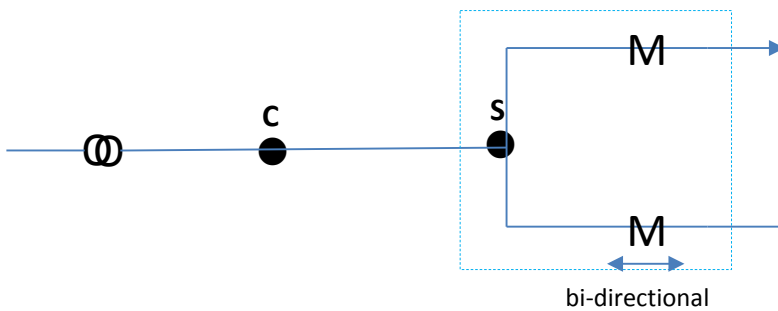

Attributes:

- One *connection point*
- One *settlement point*
- One *metering installation*
- One meter (single measurement element)
- One *NMI*
- Allocated *NMI*: 2500010101
- Identity of collected meter data stream: 2500010101 11
2500010101 12

F2.3 One customer, two meters with one assigned to a controlled load

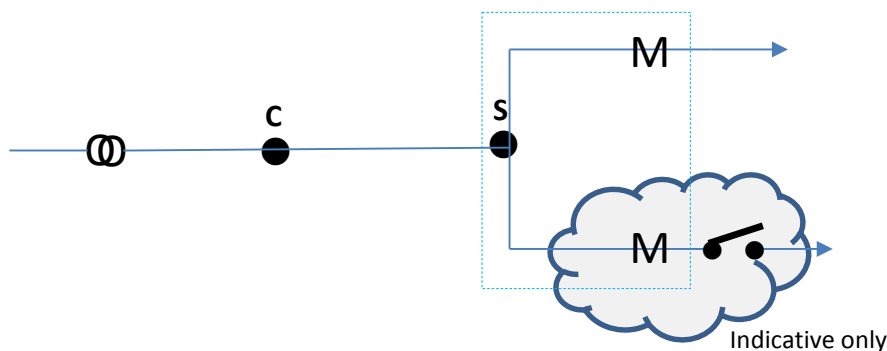

Attributes:

- One *connection point*
- One *settlement point*
- One *metering installation*
- One meter (single measurement element) – no controlled load
- One meter (single measurement element) – with controlled load
- One *NMI*
- Allocated *NMI*: 2500010101
- Identity of collected meter data stream: 250001010111
2500010101 42

F2.4 One customer, two register meter with single measurement element

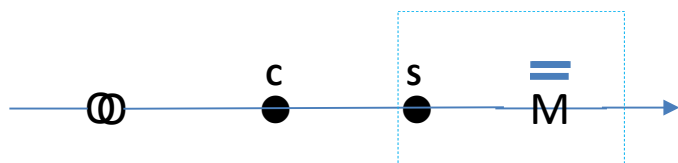

Attributes:

- One *connection point*
- One *settlement point*
- One *metering installation*
- One meter (single measurement element) – with two registers
- One *NMI*
- Allocated *NMI*: 2500010101
- Identity of collected meter data stream: 2500010101 11
2500010101 21

F2.5 One customer, two multi-function meters

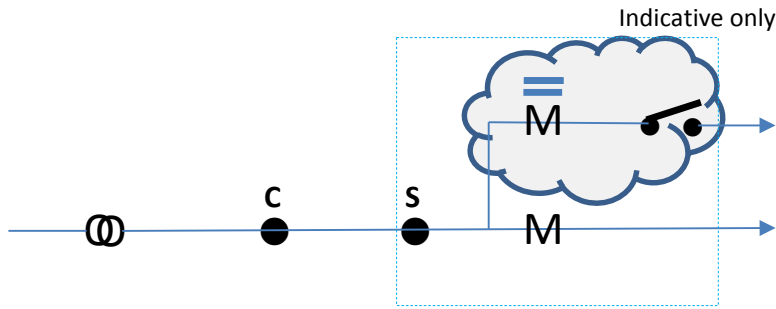

Attributes:

- One *connection point*
- One *settlement point*
- One *metering installation*
- Two meters (each with two measurement elements and associated registers)
- One *NMI*
- Allocated *NMI*: 2500010101
- Identity of collected meter data stream (meter 1): 2500010101 11
2500010101 41

F2.6 One customer, two multi-function meters

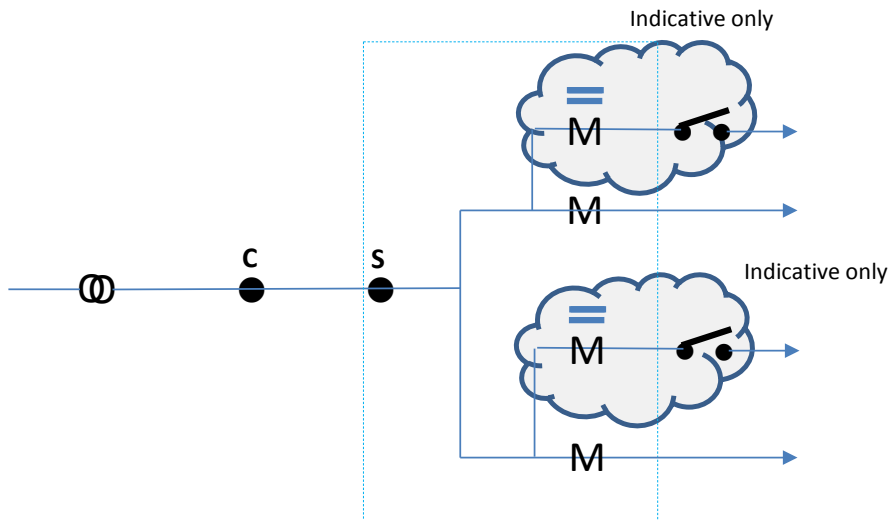

Attributes:

- One *connection point*
- One *settlement point*
- One *metering installation*
- Two meters (each with two measurement elements and associated registers)
- One *NMI*
- Allocated *NMI*: 2500010101
- Identity of collected meter data stream (meter 1): 2500010101 11
2500010101 41
- Identity of collected meter data stream (meter 2): 2500010101 12
2500010101 42